

Four quadrant operation of direct torque controlled PMSM drive using speed loop PDFF controller

Karthikeyan A^{1,*}, Prabhakaran K K¹, Nagamani C²

¹Department of Electrical and Electronics Engineering, National Institute of Technology Karnataka, Surathkal

²Department of Electrical and Electronics Engineering, National Institute of Technology, Tiruchirappalli
*jakarthik@nitk.edu.in

Abstract — This paper presents a comprehensive evaluation of proposed speed loop pseudo derivative feedforward (PDFF) controller based DTC, speed loop PI based direct torque controller (DTC) and speed loop PI based hysteresis current controller (HCC) for permanent magnet synchronous motor (PMSM) drive. The proposed controller reduces the torque and stator current ripples and significantly reduces overshoot and oscillation in the actual rotor speed. The proposed controller is verified for different cases viz., forward and reverse motoring, forward and reverse braking operation. The simulations are carried out through MATLAB/Simulink for 1.2 hp PMSM drive and results demonstrates the efficacy of the proposed controller.

Keywords—permanent magnet synchronous motor, pseudo derivative feedforward, direct torque control.

I. INTRODUCTION

In recent years, PMSM drive has drawn significant importance from the research and industry due to its high efficiency, power factor and power density. To achieve high dynamic performance of PMSM drive, current control technique is employed to confirm that current fed to the motor is closer to sinusoidal reference using hysteresis current control scheme [1-2]. Direct torque control (DTC) technique has become more popular due to improved performance of PMSM drive compared to field oriented control (FOC), as it eliminates coordinate transformation and less parameter dependence [3-8]. So, DTC is widely adopted control strategy and it is implemented to different types of machines such as induction motor, permanent magnet synchronous motor, synchronous reluctance machines [3]. DTC scheme does not involve pulse with modulation (PWM) and current regulators [4-5]. DTC based PMSM drives mainly concentrates on minimizing stator current and electromagnetic torque ripples compared to FOC [7]. The DTC achieve high torque performance under transient and steady-state conditions. DTC technique uses electromagnetic torque and flux as the control variable, where reference electromagnetic torque is generated using speed loop controller and feedback signal is obtained through flux and torque estimator [8]. PI controller based sensorless speed control of PMSM drive are also in usage for many applications. Though it has zero steady state error, it takes more time to settle. So, in order to reduce the settling time the gain values should be increased, which causes overshoot and oscillations of the system. Moreover, the presence of load disturbance also leads to overshoot and oscillations of the system. Sliding mode control based speed control of PMSM drive presented in [9-10], improves performance of drive

under parameter uncertainty and load disturbance, but it suffers from chattering phenomenon.

In this paper, speed loop pseudo derivative feedforward controller based direct torque controlled PMSM drive is presented and its performance is evaluated by comparative study with PI based DTC and PI based Hysteresis Current Control (HCC). This paper is organized as follows, in section II mathematical model of PMSM is described. In section III the proposed speed loop PDFF controller based DTC for PMSM is discussed and followed by PI based DTC scheme and PI based HCC scheme. Simulation results of the comparative analysis are demonstrated in section IV. Experimental results are discussed in in section V.

II. MATHEMATICAL MODEL OF PMSM IN THE ROTOR REFERENCE FRAME

The stator d - q voltages in terms of machine variables are expressed as [11]

$$v_{qs} = R_s i_{qs} + \omega_r \psi_{ds} + p \psi_{qs} \quad (1)$$

$$v_{ds} = R_s i_{ds} - \omega_r \psi_{qs} + p \psi_{ds} \quad (2)$$

Stator flux linkages can be expressed as

$$\psi_{ds} = L_d i_{ds} + \psi_m \quad (3)$$

$$\psi_{qs} = L_q i_{qs} \quad (4)$$

where v_{ds} and v_{qs} are the d - q axes stator voltage component, R_s stands for stator resistance, L_d and L_q present the d - q axes stator inductances, i_{ds} and i_{qs} are the d - q axes stator current component, ψ_{ds} and ψ_{qs} are the d - q axes stator flux linkage, ψ_m stands for PM flux linkage, P is number of poles.

Substituting (3) and (4) in (1) and (2), the stator current can be described as

$$\frac{d}{dt} \begin{bmatrix} i_{ds} \\ i_{qs} \end{bmatrix} = \begin{bmatrix} -\frac{R_s}{L_d} & \omega_r \frac{L_q}{L_d} \\ -\omega_r \frac{L_d}{L_q} & -\frac{R_s}{L_q} \end{bmatrix} \begin{bmatrix} i_{ds} \\ i_{qs} \end{bmatrix} + \begin{bmatrix} \frac{1}{L_d} & 0 \\ 0 & \frac{1}{L_q} \end{bmatrix} \begin{bmatrix} v_{ds} \\ v_{qs} \end{bmatrix} + \begin{bmatrix} 0 \\ -\frac{\psi_m}{L_q} \end{bmatrix} \omega_r \quad (5)$$

The electromagnetic torque, mechanical speed and position are described as

$$T_e = \left(\frac{3}{2}\right) \left(\frac{P}{2}\right) (\psi_{ds} i_{qs} - \psi_{qs} i_{ds}) \quad (6)$$

$$T_e - T_l = J \frac{d\omega_r}{dt} \quad (7)$$

$$\theta_r = \int \omega_r dt \quad (8)$$

The electrical speed and position can be expressed as

$$\omega_e = \left(\frac{P}{2}\right) \omega_r \text{ and } \theta_e = \left(\frac{P}{2}\right) \theta_r \quad (9)$$

III. SYSTEM CONFIGURATION

a. Speed loop PDFF controller based DTC for PMSM

The block diagram of proposed speed loop PDFF controller based DTC of PMSM drive is shown in Fig. 1. In the proposed method, the speed loop PDFF controller generates electromagnetic torque reference for torque control. The PI based speed control for direct torque controlled PMSM drive is presented [7], where overshoot in speed is unavoidable during changes in the system dynamics. The proposed PDFF controller eliminates overshoot and oscillation in the speed. Flux references and Electromagnetic torque are compared with estimated flux and electromagnetic torque values to generate the error signal. The flux and torque error signals are passed through hysteresis comparator thereby to generate switching logic using switching table of the DTC. Table I shows the switching table for the DTC and Fig. 2. Shows the stator flux linkage regions Θ_1 - Θ_6 .

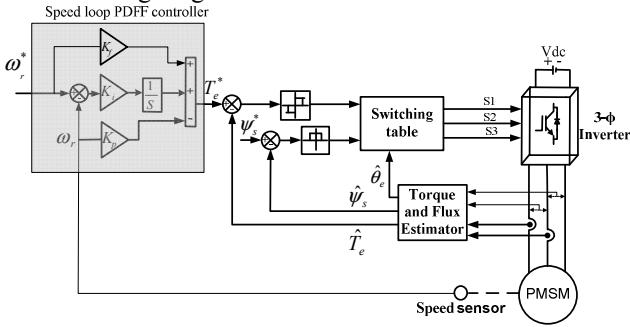

Fig. 1 Block diagram of proposed control of PMSM

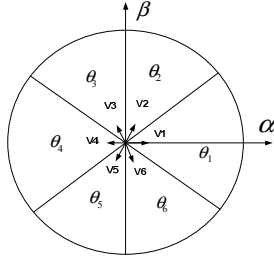

Fig. 2. Stator flux linkage regions Θ_1 - Θ_6

TABLE I. SWITCHING TABLE OF THE DTC

Ψ	T	Θ					
		Θ_1	Θ_2	Θ_3	Θ_4	Θ_5	Θ_6
1	1	110 (V ₂)	010 (V ₃)	011 (V ₄)	001 (V ₅)	101 (V ₆)	100 (V ₁)
	0	111 (V ₇)	000 (V ₀)	111 (V ₇)	000 (V ₀)	111 (V ₇)	000 (V ₀)
	-1	101 (V ₆)	100 (V ₁)	110 (V ₂)	010 (V ₃)	011 (V ₄)	001 (V ₅)
0	1	010 (V ₃)	011 (V ₄)	001 (V ₅)	101 (V ₆)	100 (V ₁)	110 (V ₂)
	0	000 (V ₀)	111 (V ₇)	000 (V ₀)	111 (V ₇)	000 (V ₀)	111 (V ₇)
	-1	001 (V ₅)	101 (V ₆)	100 (V ₁)	110 (V ₂)	010 (V ₃)	011 (V ₄)

Estimated stator flux linkages in the $\alpha\beta$ reference frame are

$$\hat{\psi}_{\alpha s} = \int (v_{\alpha s} - R_s i_{\alpha s}) dt \quad (10)$$

$$\hat{\psi}_{\beta s} = \int (v_{\beta s} - R_s i_{\beta s}) dt \quad (11)$$

$$\hat{\psi}_s = \sqrt{(\hat{\psi}_{\alpha s}^2 + \hat{\psi}_{\beta s}^2)} \quad (12)$$

$$\hat{\theta}_s = \sin^{-1} \left(\frac{\hat{\psi}_{\beta s}}{\hat{\psi}_s} \right) \quad (13)$$

where $\hat{\psi}_{\alpha s}$ and $\hat{\psi}_{\beta s}$ are the estimated stator flux in the α - β axes.

Estimated electromagnetic torque can be expressed as

$$\hat{T}_e = \left(\frac{3}{2} \right) \left(\frac{P}{2} \right) (\hat{\psi}_{\alpha s} i_{\beta s} - \hat{\psi}_{\beta s} i_{\alpha s}) \quad (14)$$

where $i_{\alpha s}$ and $i_{\beta s}$ are the stator current in the α - β axes.

b. Speed loop PI controller based direct torque controller for PMSM drive

The PI-DTC scheme [2] generally involves two loops, which are namely the outer loop speed control (PI) and inner loop torque and flux control (DTC). In the outer loop, the reference and actual speed is compared which generates speed error and is passed through speed loop PI controller to generate reference to the torque controller. The rated stator flux is considered as reference to the flux controller. The reference electromagnetic torque and stator flux are compared with estimated flux and electromagnetic torque values to generate the error signal. The instantaneous torque and flux error signals are passed through direct torque controller which generates switching pulse to the voltage source inverter.

c. Speed loop PI controller based Hysteresis current controller for PMSM drive

The PI-HCC scheme [2] generally involves two loops, which are namely the outer loop speed control (PI) and inner loop current control (HCC). PI speed controller generates reference q -axis stator current and d axis stator current is considered as zero. By using inverse park transformation, the reference d - q axes stator currents are converted into three phase stator current reference (i_a^* , i_b^* , i_c^*). The reference and actual stator currents are compared to generate instantaneous stator current error and is fed to the hysteresis band which generates switching logic for the voltage source inverter.

d. Performance analysis of speed loop PI and PDFF controller for PMSM drive

In this section, to analyze the performance of proposed PDFF-DTC, PI-DTC and PI-HCC schemes, the outer speed loop is considered. Simulation results for speed control of PMSM drive based on the proposed method shows an improvement in dynamic performance i.e. settling time and overshoot of the system compared with speed loop PI controller for PMSM drive. Fig. 3 shows the block diagram of outer loop for PDFF-DTC. Fig. 4 shows the block diagram of outer speed loop for PI-DTC and PI-HCC.

To validate the robustness of the outer speed loop of PDFF and PI controller, the different controller gain values are considered as shown in Fig. 5. It can be seen that, the overshoot generated by the PDFF controller ranges from 76.5% to 0% and the overshoot produced by the PI controller ranges from 76.5% to 10.5%. It is also observed that overshoot

of the PDFF system is much smaller than that of the PI system. Fig. 6 shows bode diagram of the speed loop PI and PDFF controller. It is observed from Fig. 6, that the magnitude gain of the speed loop PDFF controller is much lower than that of the speed loop PI system, which reduces overshoot of the system.

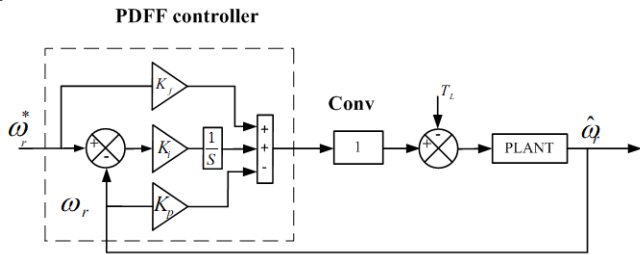

Fig. 3. The structure of speed loop PDFF controller

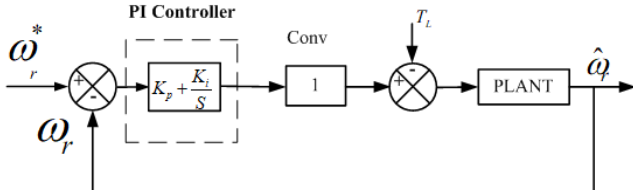

Fig. 4. The structure of speed loop PI controller

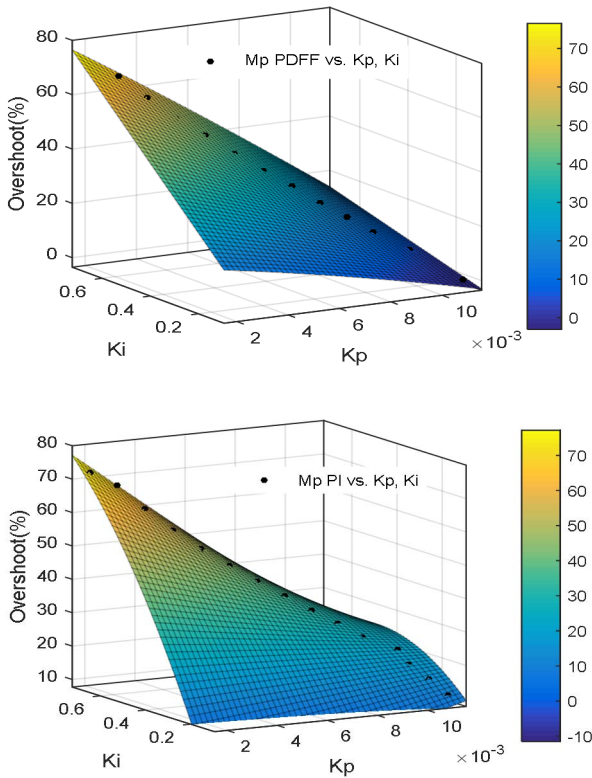

Fig. 5. Overshoot of PI and PDFF controller with different K_p and K_i (K_i/K_p) values (a) PDFF controller (b) PI controller

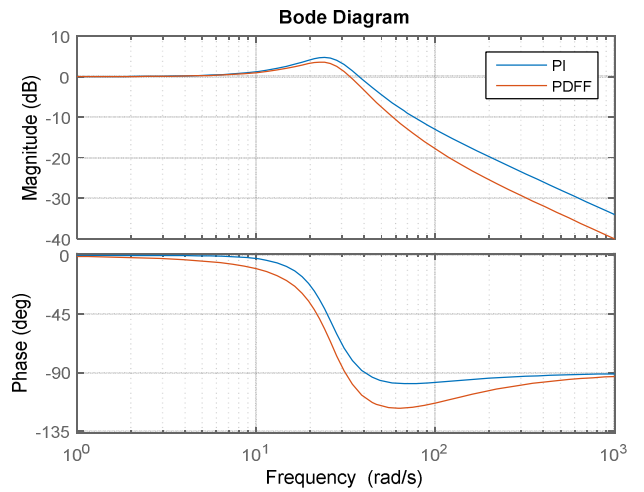

Fig. 6 Bode diagram for the closed loop transfer function of speed loop PI (with DTC & HCC) and PDFF based DTC.

IV. SIMULATION RESULTS

The simulation of proposed speed loop PDFF controller based DTC for PMSM drive is carried out using MATLAB / SIMULINK. The performance of proposed method is analyzed under four quadrant operation and a comparative analysis is performed between speed loop PDFF, PI controller based DTC and speed loop PI based hysteresis current controller (HCC) for PMSM drive in all the four quadrant operations. The parameters of the PMSM are given in Table I.

Case - 1 Forward and Reverse motoring operation

Fig. 7 shows forward and reverse motoring operation of drive when the speed reference is varied between 178 rad/s to -178 rad/s and load torque is varied between 4 N.m to -4 N.m at 1s. Fig 7a compares the actual speed response of speed loop PI-DTC, PDFF-DTC and speed loop PI-HCC for PMSM drive. It shows that the actual rotor speed of PDFF controller takes 0.056s to follow the speed reference. Fig 7b shows the electromagnetic torque response for the proposed controller. It is clear from fig. 7b that, the PDFF-DTC of PMSM drive has smooth dynamic response during transient period with an overshoot of 6.4 N.m from the nominal value of 4 N.m which is less compared to speed loop PI-DTC system (8.8N.m) and speed loop PI-HCC system. Fig 7 c, d and e shows the stator response for speed loop PDFF-DTC, PI-DTC and PI-HCC system. It can be observed that the proposed method has fast transient response. Table II shows the transient and steady state electromagnetic torque ripple when the speed is varied between 0 to 178 rad/s and the load torque is gradually varied from 0 to 4.5 N.m. It is found that, the proposed speed loop PDFF-DTC has reduced torque ripple during transient conditions compared with speed loop PI-DTC and speed loop PI-HCC. At rated torque, PDFF-DTC has an overshoot of 7.27 N.m (61.5%) from the nominal value of 4.5 N.m which is less compared with speed loop PI-DTC (>100%) and speed loop PI-HCC (>100%).

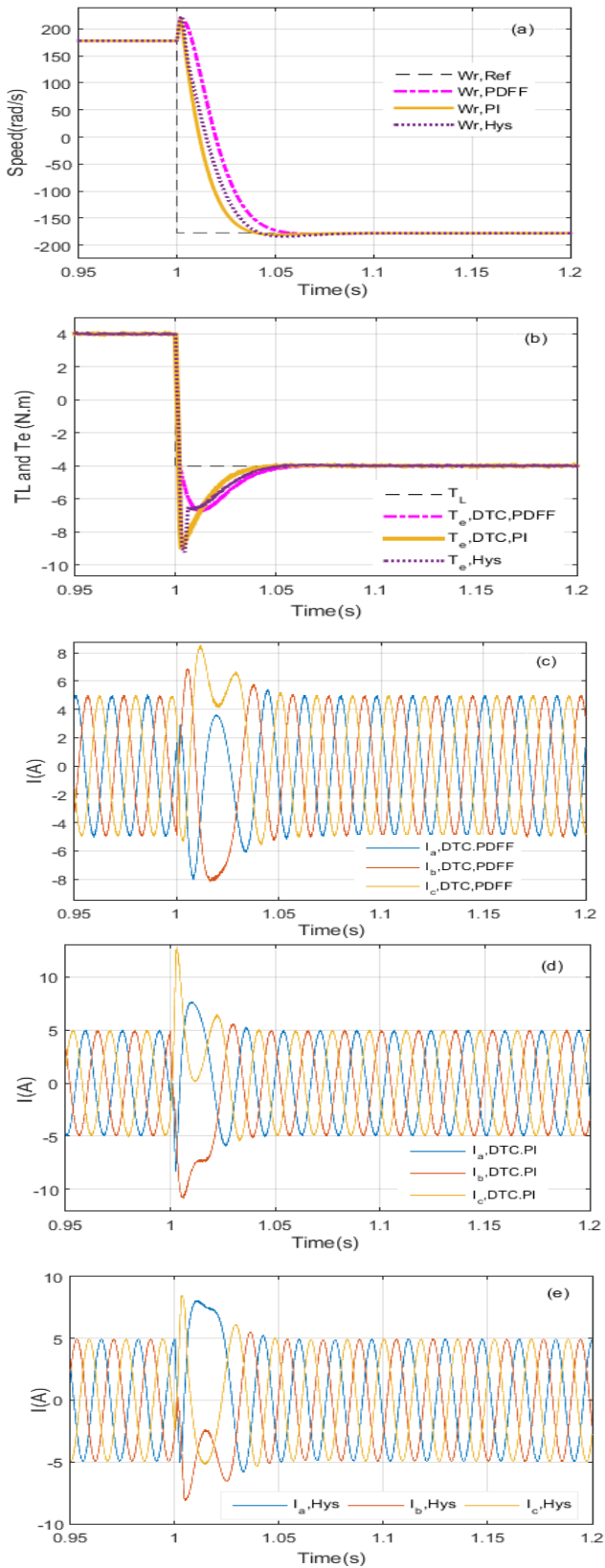

Fig. 7 Forward and reverse moting operation of PMSM drive

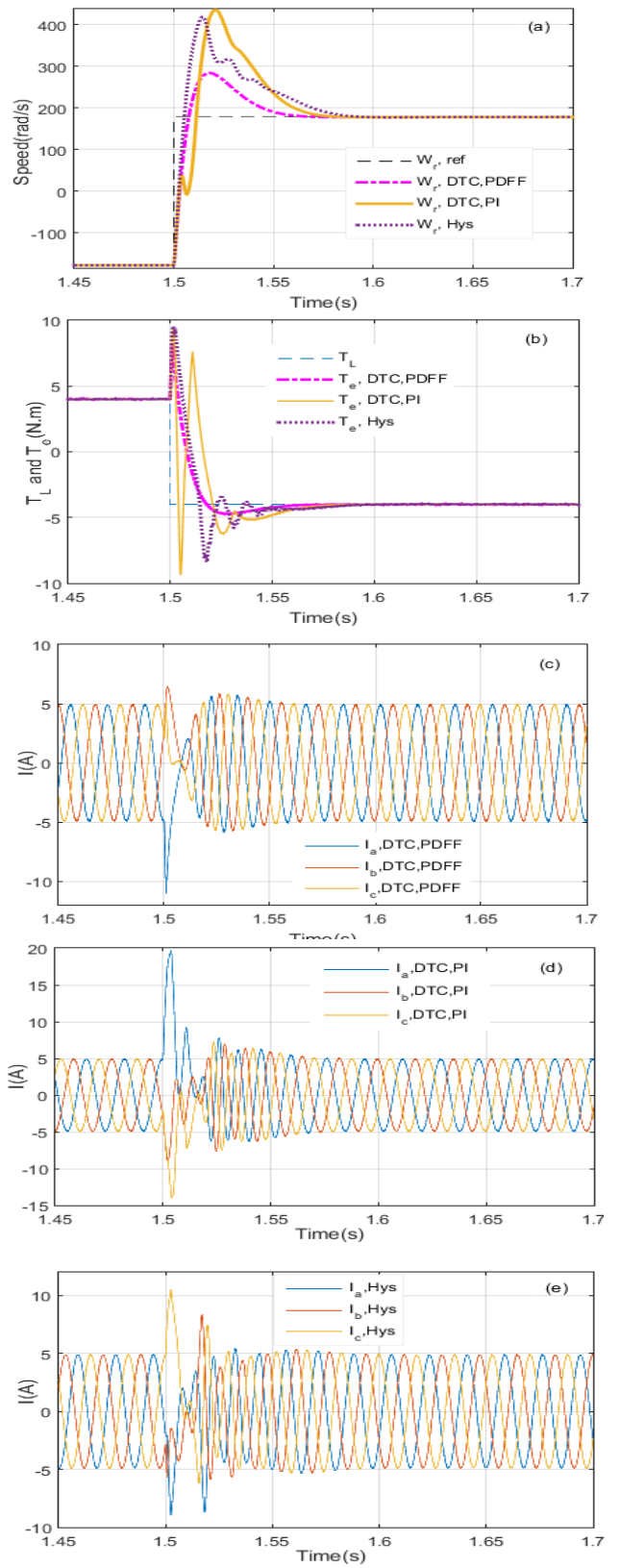

Fig. 8 Forward and reverse braking operation of PMSM drive

Case - 2 Forward and reverse braking operation

Fig. 8 shows forward and reverse braking operation of PMSM drive when the speed reference is varied between -178 rad/s to 178 rad/s and load torque is varied between 4 N.m to -4 N.m at 1.5 s. Fig 8a shows that the speed loop PDFF based DTC takes 0.06 s to follow the speed reference and significantly reduces the overshoot i.e PDFF-DTC has 57.3% , PI-DTC and PI-HCC has greater than 100% (double of PDFF-DTC). It is observed from Fig. 8b that, during transient condition the PDFF-DTC and PI-DTC and HCC system has an overshoot upto 4.5 N.m (12.5%), 9.8 N.m ($>100\%$) & 8.2 N.m ($>100\%$) respectively at 1.5 s from the nominal value of 4 Nm. Thus, the proposed PDFF based DTC improves electromagnetic torque response during transient condition. Fig 8 c, d and e shows the stator current response for the PMSM drive during forward and reverse braking operation. It is clear that, with the PI-HCC and PI-DTC system stator current response does not exhibit smooth response during the transient period, where as the proposed PDFF-DTC has fast and smooth transient response.

V. EXPERIMENTAL RESULTS

This section demonstrates the experimental results of forward and reverse motoring operation for a 1.2 hp PMSM drive. The hardware setup consists of three phase IGBT inverter (SEMIKRON make VSI, 750 V, 30 A, 20 kHz) to control PMSM where the switching pulses are generated from SPWM technique with a switching frequency(VSI) of 5 KHz and sampling time of 100 μ s. The control platform is based on Altera cyclone-II FPGA controller. Voltage sensor & current sensor (LV – 25 P & LAH 25 – NP) are used respectively to sense the motor voltage and current thereby given to OPA 227 P (OP-AMP) – signal conditioning circuit. Finally a differential encoder (1024 PPR) is used to obtain the actual rotor speed and position of motor.

The speed reversal is considered from 30 to -30 rad/s and vice versa is demonstrated in fig. 9a. It is found that during speed reversal operation, actual speed follows the speed command.

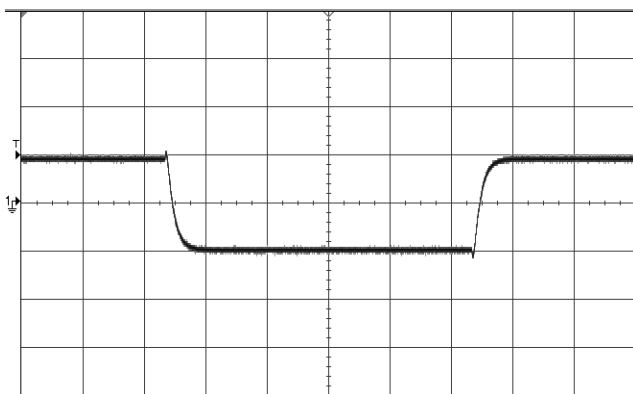

Fig. 9 Experimental results for speed reversal operation
Scale: (ω)(PDFF) = 30 rad/s/div), (T) = 1 s/div)

VI. CONCLUSION

In this paper, four quadrant operation for speed loop Pseudo derivative feedforward controller based direct torque controlled PMSM drive has been presented. A comparative analysis is performed between PDFF-DTC, PI-DTC and PI-HCC for PMSM drive. It is found that the proposed controller reduces overshoot and oscillation of PMSM drive and thereby minimize the stator current and electromagnetic torque ripples. The proposed speed loop PDFF-DTC performs well in different test conditions viz., forward and reverse motoring, forward and reverse braking operation. Simulation and experimental results demonstrate the efficacy of the proposed Speed loop PDFF controller based direct torque controlled PMSM drive.

APPENDIX

TABLE I. PMSM RATING AND PARAMETERS

Stator: 3ph, 4 pole, 220 v, 900 W, 1700 rpm

Parameter	Measured value in SI units
R_s	4.3 Ω
L_d	27 mH
L_q	67 mH
λ_m	0.272 Wb
J	0.00179 kg m ²

TABLE II. Transient and steady state ripple of PDFF-DTC, PI-DTC and PI-HCC

T_L (N.m)	T_e ripple (transient/steady state in N.M), speed varied between 0 to 178 rad/s		
	Speed loop PDFF with DTC	Speed loop PI with DTC	Speed loop PI with HCC
0	$2.78/0.01$	$5.05/0.08$	$4.28/0.1$
1	$3.7/0.12$	$6/0.1$	$5.28/0.1$
2	$4.71/0.12$	$7.04/0.12$	$6.28/0.12$
3	$5.78/0.12$	$8.12/0.14$	$7.17/0.2$
4	$6.75/0.18$	$9/0.2$	$8.18/0.2$
4.5	$7.27/0.18$	$9.35/0.18$	$8.6/0.4$

REFERENCES

- [1] M. P. Kazmierkowski and L. Malesani, "Current control techniques for three-phase voltage-source PWM converters: a survey," *IEEE Trans. Ind. Electron.*, vol. 45, no. 5, pp. 691–703, Oct. 1998.
- [2] N.P. Ananthamoorthy; and K. Baskaran, "Simulation of PMSM based on current hysteresis PWM and Fed PI controller", in Proc. Computer Communication and Informatics (ICCCI), pp. 1–5, 2012.
- [3] L. Zhong, M. F. Rahman, W. Y. Hu, and K. W. Lim, "Analysis of direct torque control in permanent magnet synchronous motor drives," *IEEE Trans. Power Electron.*, vol. 12, no. 3, pp. 528–536, May 1997.
- [4] L. Tang, L. Zhong, M. F. Rahman, and Y. Hu, "A novel direct torque control for interior permanent-magnet synchronous machine drive with low ripple in torque and flux—a speed-sensorless approach," *IEEE Trans. Ind. Appl.*, vol. 39, no. 6, pp. 1748–1756, Nov./Dec. 2003.
- [5] L. Tang, L. Zhong, M. F. Rahman, and Y. Hu, "A novel direct torque controlled interior permanent magnet synchronous machine drive with low ripple in flux and torque and fixed switching frequency," *IEEE Trans. Power Electron.*, vol. 19, no. 2, pp. 346–354, Mar. 2004.
- [6] G. Foo and X. Zhang, "A Constant Switching Frequency Based Direct Torque Control of Interior Permanent Magnet Synchronous Motors with Reduced Ripples and Fast Torque Dynamics," *IEEE Trans. Power Electron.*, vol. PP, pp. 1–1, 2015.
- [7] F. Niu, B. Wang, A. S. Babel, K. Li, and E. G. Strangas, "Comparative evaluation of direct torque control strategies for permanent magnet synchronous machines," *IEEE Trans. Power Electron.*, vol. 31, no. 2, pp. 1408–1424, Feb. 2016.

- [8] K. Chikh, M. Khafallah, A. Saad, D. Yousfi, and H. Chaikhy, "A novel fixed-switching-frequency DTC for PMSM drive with low torque and flux ripple based on sinusoidal pulse width modulation and predictive controller" in Proc. ICMCS, pp. 1069–1075, 2012.
- [9] Gilbert Foo, M. F. Rahman, "Direct Torque Control of an IPM-Synchronous Motor Drive at Very Low Speed Using a Sliding-Mode Stator Flux Observer," *IEEE Trans. Power Electron.*, vol. 25, no. 4, pp. 933–942, April 2010.
- [10] J.-S. Choi, Y.-S. Kim. Sensorless PMSM drive with a sliding mode control based adaptive speed and stator resistance estimator. *IEEE Trans. Magn.* Vol. 36, pp. 3588–3591, 2000.
- [11] Vas P., *Sensorless Vector and Direct Torque Control*, Oxford University Press (UK), 1998.