

A Feed-Forward/Feedback Run-to-Run Control of a Mixed Product Process: Simulation and Experimental Studies

Ming-Feng Wu, Wei-Keng Lin, Choi-Lin Ho, David Shan-Hill Wong,* Shi-Shang Jang,* Ying Zheng,[†] and Abhinav Jain[‡]

Department of Chemical Engineering, National Tsing-Hua University, Hsin Chu 300, Taiwan

Run-to-run (RtR) control is an important quality assurance method for batch-based manufacturing process. Usually, products of different grades are produced on a tool that will experience gradual drift between maintenance cycles. A feed-forward/feedback RtR control strategy that compensates this drift for all products manufactured on this tool was proposed. This and other RtR control schemes were analyzed and validated by simulation and experimentally using a bench scale reactor that produces silica particles with different diameters by a sol–gel process. A simple EWMA (exponentially weighted moving average) RtR control scheme based on products of the same grade was found to be stable but inefficient for infrequent products. A simple EWMA RtR control scheme that attributed disturbance entirely as the effect of tool drift was found to be unstable. The feed-forward/feedback RtR control proposed was able to maintain stable quality by effectively utilizing information about tool changes to adjust recipes of infrequent products.

1. Introduction

Recently, run-to-run control has been widely accepted as a product quality assurance technology that can eliminate shift, drift, and patterned variations in the semiconductor manufacturing industry.^{1–3} Logically it can also be used in any batch-production based industries such as pharmaceutical, fine chemicals, biotechnology, etc. Early theories of RtR control in the literature deal with control of a single product.⁴ However, in batch-production based industries, usually a variety of high-value-added products of small quantities with different grades are produced in a generic set of equipments (tools). Such a production mode is called a mixed-run system. If a quality offset is detected for a batch, it is not known whether the disturbance would influence this particular product only or a generic effect originating from the specific equipment would affect all products. A possible approach is to attribute all disturbances to the changes in tool condition. Zheng et al.⁵ showed that a simple EWMA control based on a linear input–output model and a single tool disturbance parameter, i.e., a “tool-based” approach, will be unstable if (1) model uncertainties of different products are not the same and (2) the system exhibits a nonstationary disturbance. Another way to practice RtR control is to determine recipe adjustments for the next batch based on the recent batches in which the same product is produced. We shall denote this approach a “product based” approach. Firth et al.⁶ refer to this practice as a “threaded” approach for a multitool and multi-product system. It is obvious that the effect of RtR control will be minimal if the break between two successive runs of the same product becomes long. Alternatively, one may try to quantify the disturbances due to different sources and calculate recipe adjustments for future runs by recombining these factors.⁶

* To whom correspondence should be addressed. Department of Chemical Engineering National Tsing Hua University 101, Section 2, Kuang Fu Road, Taiwan, 30013, ROC. Phone: +886-3-573-5294. Fax: +886-3-571-5408. E-mail: S.-S.J., ssjang@mx.nthu.edu.tw; D.S.-H.W., dshwong@che.nthu.edu.tw.

[†] Huazhong University of Science and Technology, Department of Control Science and Engineering, Wuhan, Hubei 430074, P. R. China.

[‡] Department of Chemical Engineering, National Institute of Technology Karnataka, Surathkal 575025, India.

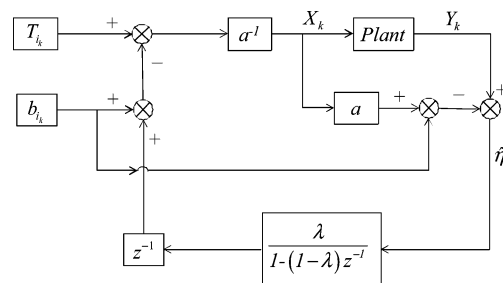

Figure 1. Tool-based EWMA RtR control scheme.

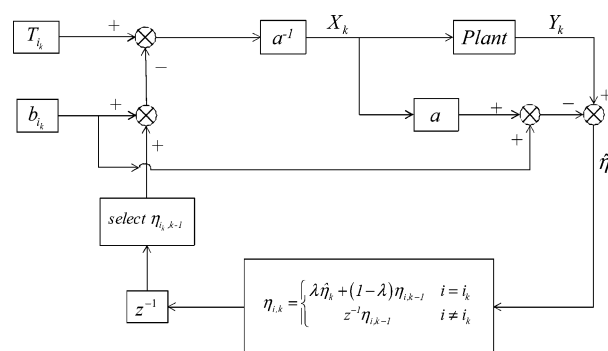

Figure 2. Product-based EWMA RtR control scheme.

Pasadyan and Edgar⁷ showed that the biases caused by tools and products are not observable unless some blank runs are used to calibrate the condition of the tool.

In actual practice, a tool usually exhibits significant drifts within a preventive maintenance cycle. For example, in chemical-mechanical polishing (CMP), pad conditioning immediately after a pad change and pad wear require that different polishing times be used.^{8–10} It is desirable that a RtR control scheme be developed to effectively compensate such drifts while recognizing that products of different grades are being produced in different runs. In this work, a stable RtR control scheme that eliminates the drift characteristics of the equipment using a feed-forward control is proposed.

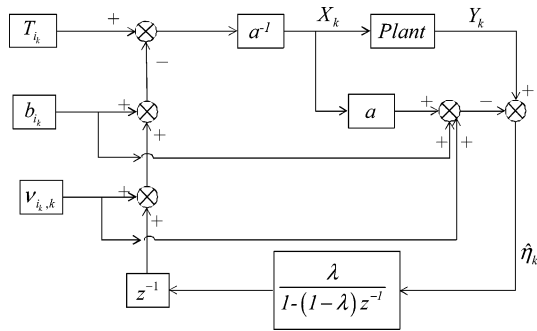

Figure 3. Feed-forward/feedback RtR control scheme.

Online batch particle size control in the production of submicron particles has been extensively investigated.^{11,12} Integration of within batch and batch-to-batch control has also been studied.^{13,14} Because a bench-scale experiment¹⁵ is relatively easy to set up and empirical models for predicting the size of silica particles have been developed,¹⁶ it serves as a good platform for testing various mixed product run run-to-run control strategies.

The rest of this paper is organized as follows. In section 2, the basic algorithms of the tool-based approach and the product-based approach are introduced and our proposed feed-forward + feedback approach is developed. In section 3, the process and disturbance models used in the controller are described. Details of experiments and simulator model are given in Appendices A and B. Simulation results and experimental validations are presented in section 4. Last, conclusions from this study are given in section 5.

2. Development of a Feed-Forward/Feedback Controller

Consider a tool on which $i = 1, \dots, n$ products are processed. In general, the output response of the k th run is dependent on the value of the input X_k employed, the type of product i_k , some disturbance ω_k specific to the tool, some disturbance δ_{ik} specific to the product, and some random noise ϵ_k

$$Y_k = f(X_k, \omega_k, \delta_{i_k}) + \epsilon_k \quad (1)$$

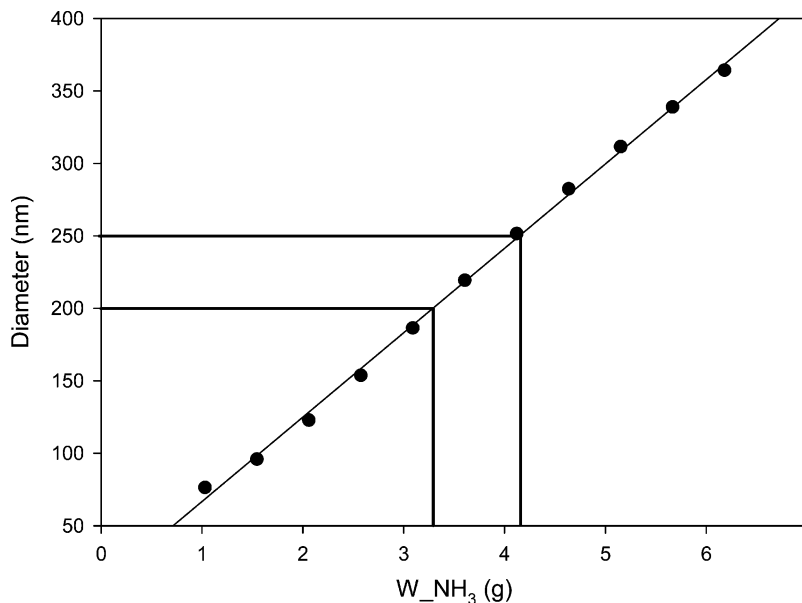

Figure 4. Linear process gain model for the two products.

In RtR control, usually a static linear plant model in which all products share a common process gain but have different bias terms can be expressed as follows:

$$\check{Y}_k = aX_k + b_{i_k} \quad (2)$$

If we assume that the observed disturbance is independent of the type of product

$$\hat{\eta}_k = Y_k - aX_k - b_{i_k} \quad (3)$$

A standard “tool-based” EWMA controller is given by

$$\eta_k = \lambda \hat{\eta}_k + (1 - \lambda)\eta_{k-1} \quad (4)$$

$$X_{k+1} = \frac{(T_{i_{k+1}} - \eta_k)}{a} \quad (5)$$

Figure 1 shows the block diagram of such a “tool-based” controller. However, Zheng et al.⁵ showed that because differences between products are disregarded, such a simple EWMA control will have stability problems when there is a nonstationary tool disturbance.

If we assume that the difference between observation Y_k and the model prediction \hat{Y}_k is specific to the product i_k

$$\hat{\eta}_{k,i_k} = Y_k - aX_k - b_{i_k} \quad (6)$$

A product-based EWMA RtR controller that is specific to a product can be written as

$$\eta_{k,i} = \begin{cases} \lambda \hat{\eta}_{k,i} + (1 - \lambda)\eta_{k-1,i} & i = i_k \\ \eta_{k-1,i} & \text{otherwise} \end{cases} \quad (7)$$

$$X_{k+1} = \frac{(T_{i_{k+1}} - \eta_{k,i_{k+1}})}{a} \quad (8)$$

Figure 2 describes the block diagram of a standard EWMA controller. Because the controller is product specific, it is obvious that the control action will become more and more sluggish if the interval between runs for the product becomes large. Control performance will be degraded.

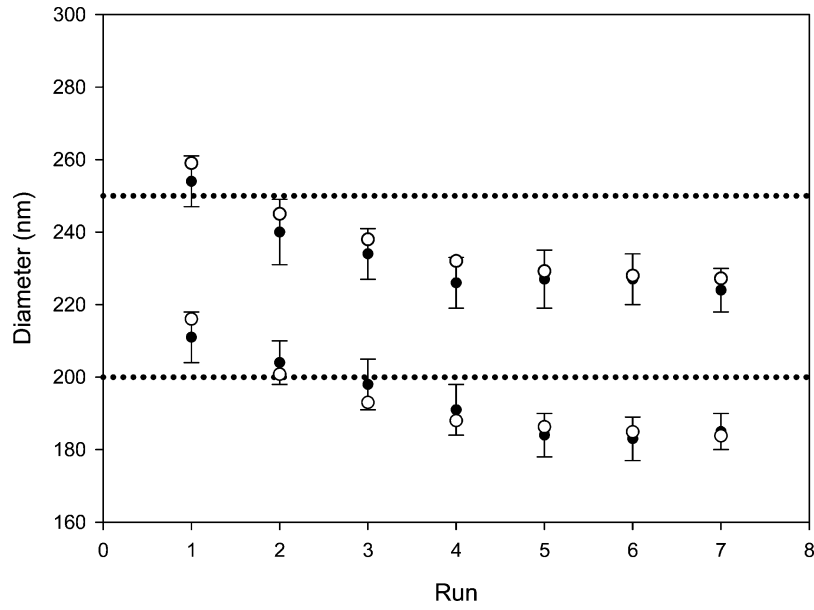

Figure 5. Process disturbance models of drifts in particle diameter due to decay in ammonia concentration: (●) experiment; (○) simulation.

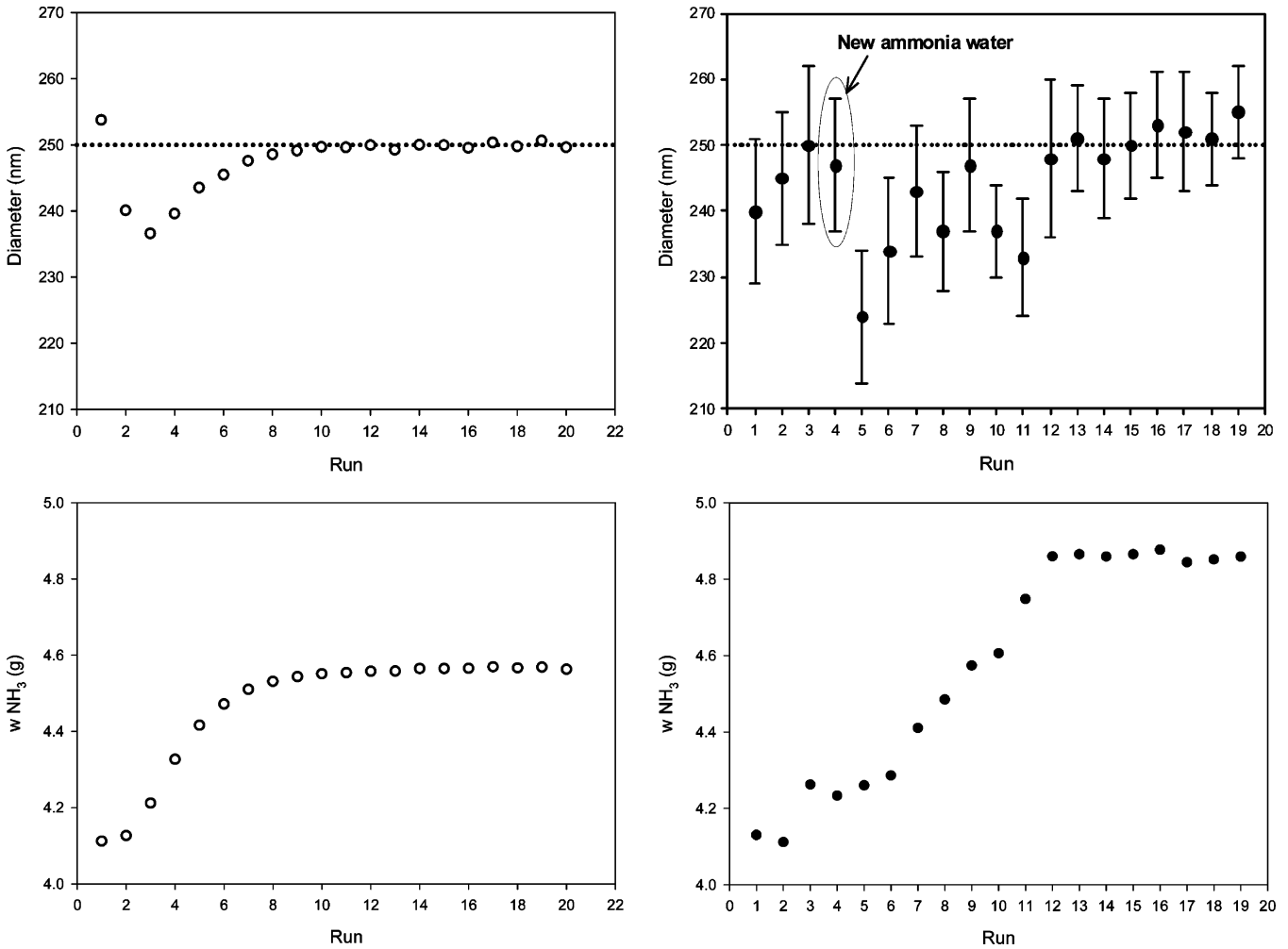

Figure 6. Simulation and experimental results of single product EWMA control for Target = 250 nm products: (●) experiment; (○) simulation.

Zheng et al.⁵ present a general analysis of the “tool-based” approach. It showed that a tool-based approach becomes unstable when (1) the disturbance is nonstationary and (2) model errors for different products are different. Readers are referred

to the paper for mathematical details. Our main conjecture in this work is that if the pattern drift is eliminated by a feed-forward control, the remaining disturbance will be stationary. A simple integral control will be sufficient to maintain the

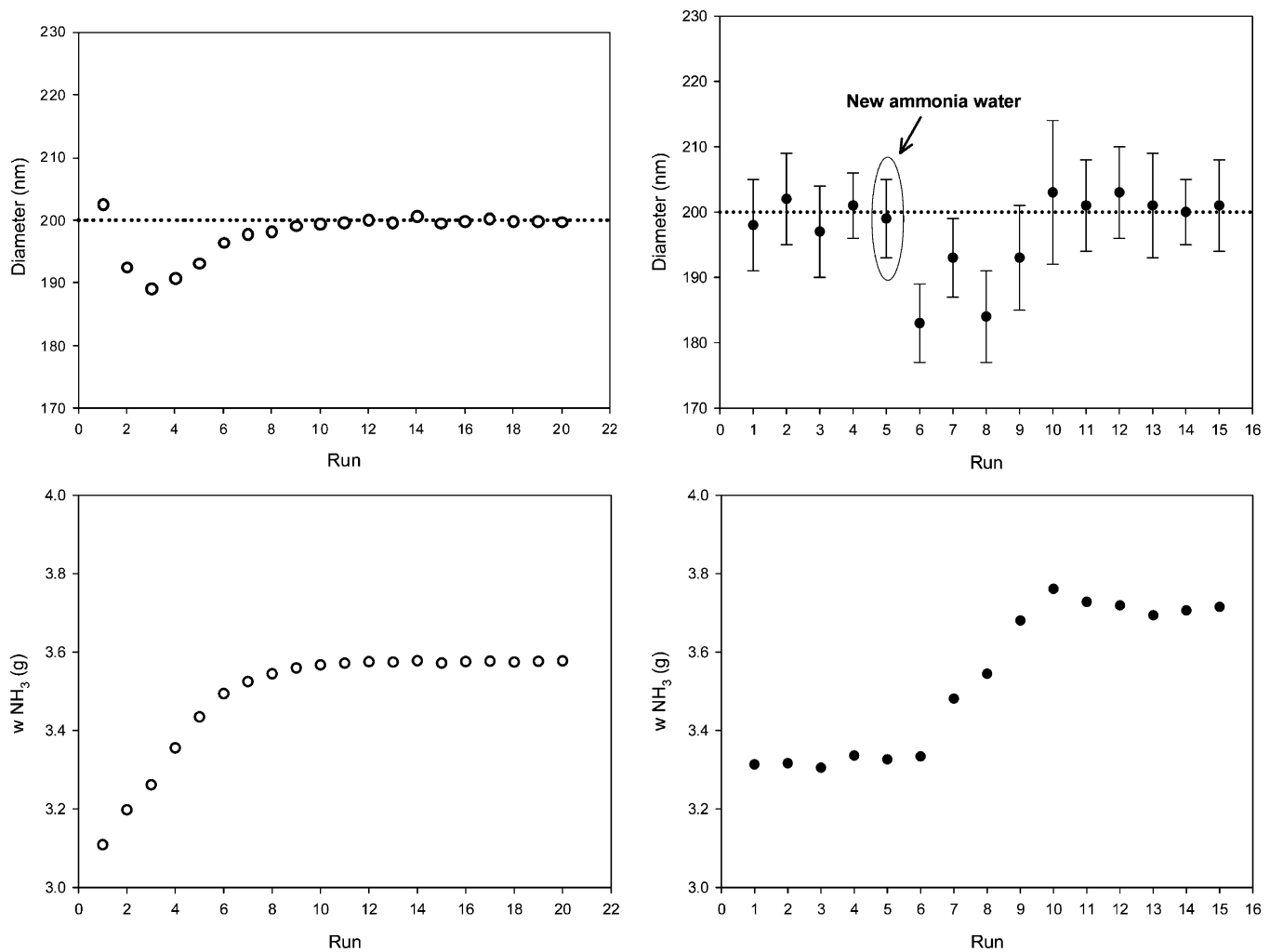

Figure 7. Simulation and experimental results of single product EWMA control for Target = 200 nm products: (●) experiment; (○) simulation.

quality of the system. If we assume that there exists a patterned change in tool condition, and its effects on different products are known in a priori, the model becomes

$$\hat{Y}_k = aX_k + b_{i_k} + v_{k,i_k} \quad (9)$$

A feed-forward + feedback controller can be written as follows

$$\hat{\eta}_k = Y_k - aX_k - b_{i_k} - v_{k,i_k} \quad (10)$$

$$\eta_k = \lambda \hat{\eta}_k + (1 - \lambda)\eta_{k-1} \quad (11)$$

The block diagram of this controller is given in Figure 3.

$$X_{k+1} = \frac{(T_{i_{k+1}} - \eta_k - b - v_{k+1,i_{k+1}})}{a} \quad (12)$$

3. Process and Disturbance Model

Submicron SiO₂ can be produced using a bench scale reactor. The overall chemical reaction involves hydrolysis and condensation (Stöber et al.¹⁵):

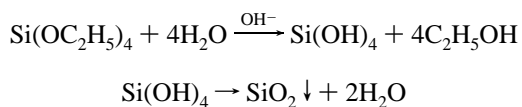

Details of the experimental setup and procedure are given in Appendix A.

An empirical model was developed by Bogush et al.¹⁶ to predict the diameters of SiO₂ particles in a similar experiment. It is used as a simulator for testing controller performance. Details of the model are given in Appendix B.

In our experiments, two sizes of silica particles, 200 and 250 nm, are produced. For both grades, initial concentrations of TEOS and water in reactant are fixed at 0.17 M TEOS and 5 M H₂O, respectively. The diameter of the particle depends only on the amount of aqueous ammonia added. Figure 4 shows the results of a series of open loop experiments carried out using different weights of aqueous ammonia. With Y representing the particle diameter, a linear process gain model can be also established for use in RtR control:

$$\hat{Y} = aW_{\text{NH}_3} + b = 58.2W_{\text{NH}_3} + 8.5 \quad (13)$$

The weights required to produce particles of 250 and 200 nm are approximately 4.2 and 3.3 g, respectively.

However, the actual concentration of the aqueous ammonia varies from bottle to bottle for the industrial grade product. When a fresh bottle of ammonia is being used, its original seal is broken. Between runs, the ammonia stock is stored in a hood at room temperature in a capped bottle. The cap is not entirely leak-proof. Furthermore, due to its high volatility, ammonia vapor will be lost during the preparation procedure when the

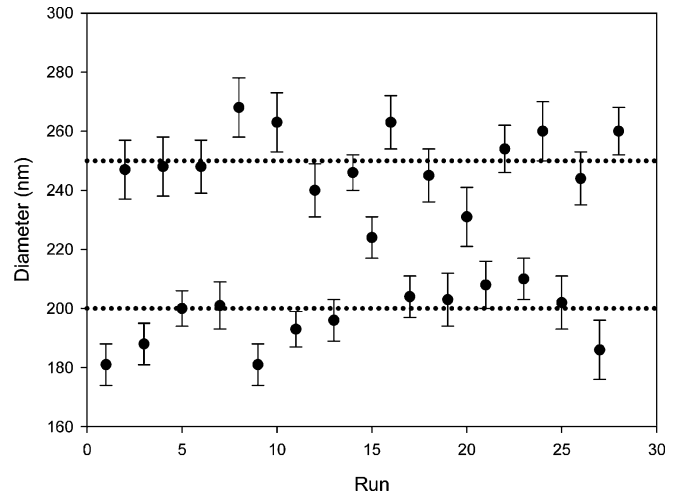
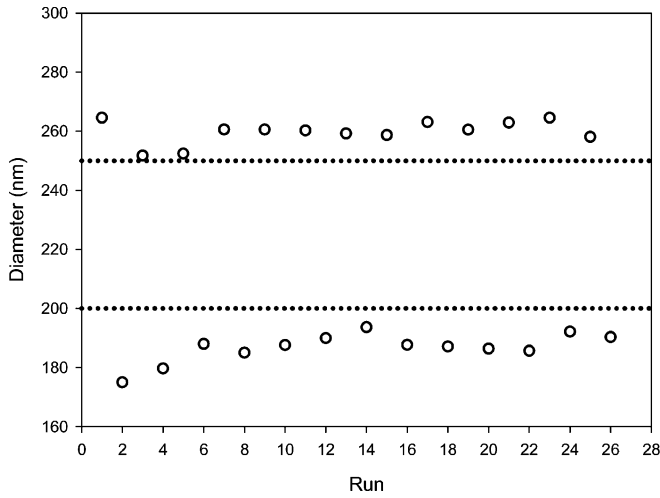
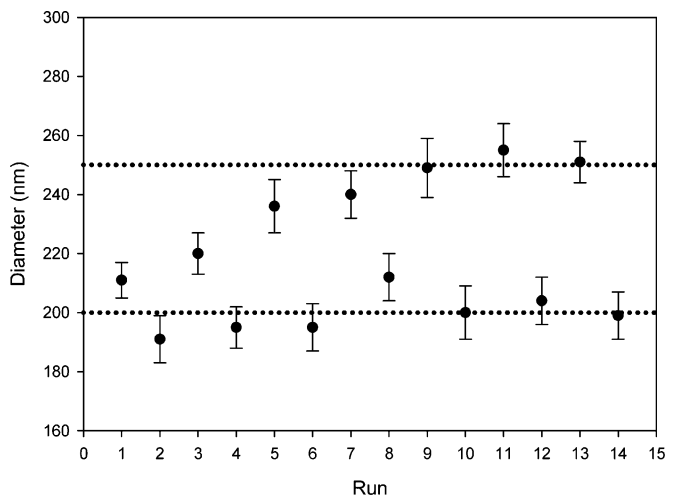
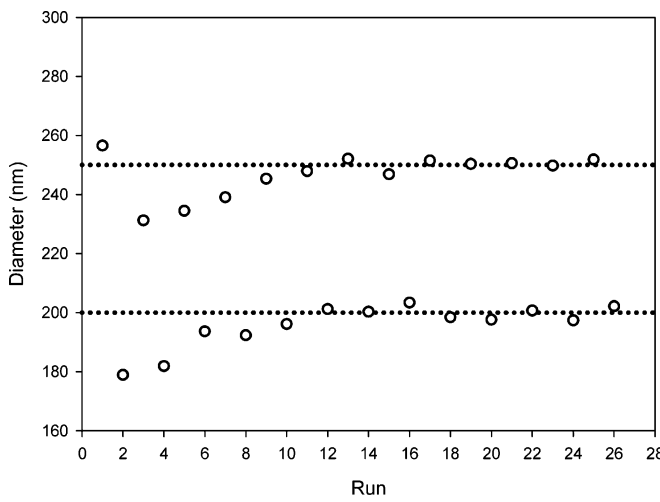
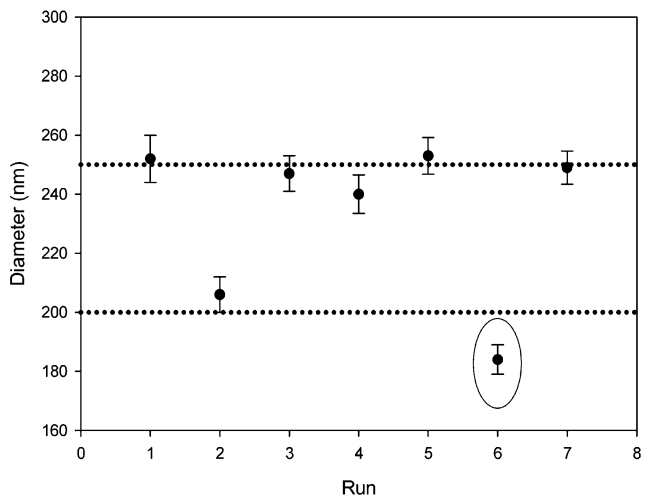
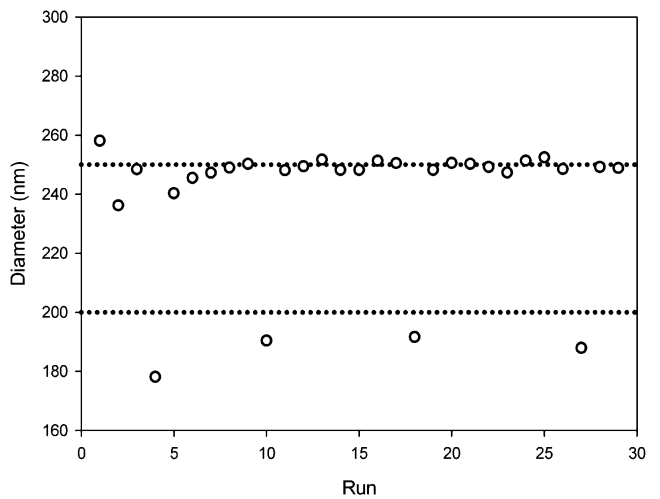

Figure 8. Simulation and experimental results of mixed product runs using tool-based EWMA RtR control: (●) experiment; (○) simulation.



(a) Alternate productions



(b) One infrequent product

Figure 9. Simulation and experimental results of mixed product runs using product-based EWMA RtR control: (●) experiment; (○) simulation.

capped bottle is opened and the aqueous ammonia stock is exposed to air during preparation of the ammonia feed for a run (see step 3 of appendix A). Hence, the concentration of the ammonia stock solution decreases from run to run until the bottle is used up and a fresh bottle is opened. Figure 5 shows open loop experimental results when the weight of ammonia solution

added is maintained at 4.2 and 3.3 g, respectively. By fitting the experimental data, we can develop two empirical process disturbance models:

$$v_{k,i} = \begin{cases} 30.1 - 250.4e^{-0.52(n_k+3)} & i_k = 1, \text{ i.e. Target} = 250 \\ 18.1 - 220.3e^{-0.52(n_k+3)} & i_k = 2, \text{ i.e. Target} = 200 \end{cases} \quad (14)$$

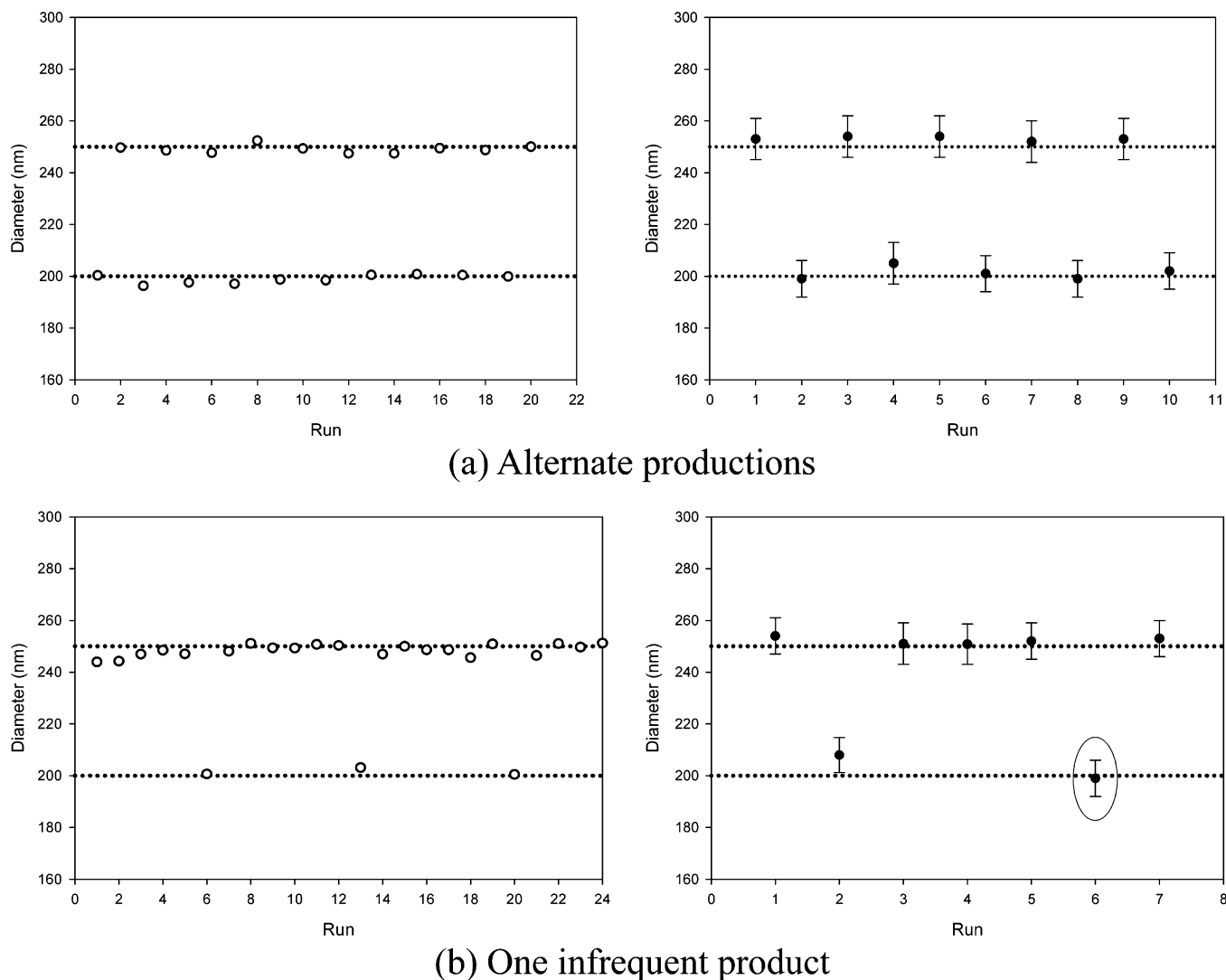

Figure 10. Simulation and experimental results of mixed product runs using the feed-forward + feedback RtR control: (●) experiment; (○) simulation.

with n_k being the number of runs performed after the original seal of a bottle of ammonia is broken.

4. Results and Discussions

4.1. Single Product Control. If only one grade of product is produced, the diameter of the particle can be controlled from run to run by a simple EWMA controller. Simulation and experimental results of single product run-to-run control are shown in Figures 6 (target = 250 nm) and 7 (target = 200 nm). The simulation results show that as the concentrations of aqueous ammonia decrease, the EWMA controller will adjust the weight of ammonia added. In the experiments, we found that whenever a new bottle of stock ammonia is used, upsets will be introduced and the controller will automatically adjust the weight of aqueous ammonia used until a suitable weight is found when the decay in concentration of aqueous ammonia becomes negligible. All subsequent runs will be close to the targets.

4.2. “Tool-Based” Control of a Mixed Production. Tool-based RtR control as described by eqs 3–5 is tested in two very simple scenarios: (i) two type of particles are produced alternatively and (ii) particles of 200 nm are produced once in every three or four runs. The second scenario simulates the situation when there minor products produced infrequently. The

simulation and experimental results are illustrated in Figure 8 and show that this approach did not work because the effects of decay in ammonia concentration on the production of particles with different diameters were not the same.

4.3. “Product-Based” Control of a Mixed Production. Figure 9a shows the simulation and experimental results of the product-based controller as given by eqs 6–8 for the first scenario. We found that the product-based EWMA controller is able to bring the system to the correct targets. However, if particles with 200 nm are produced only sparingly, it is not possible for the controller to recognize the change in concentration of the aqueous ammonia stock solution. Hence, the quality of this infrequent product will be off-target, as confirmed by simulation and experimental results in Figure 9b.

4.4. Feed-Forward and Feedback Control. Simulation and experiment results of the proposed feed-forward + feedback scheme as given by eqs 10–12, with a predetermined disturbance model given by eq 14, are shown in Figure 10a. This controller was able to control the quality of different products and the response time was much faster than product-based control. Furthermore, Figure 10b showed that even though a product was encountered, its production recipe can be quickly adjusted by the information of tool change.

5. Conclusion

In this work, a bench scale reactor that produces silica particles with different diameters by a sol-gel process was used as a platform to explain and compare several RtR control philosophies for batch-based mixed run production. We showed that even the disturbance came from changes in condition of the tool; its effects on different products may not be exactly the same. Information obtained in previous runs of different products should only be used with careful discretion. A tool-based EWMA approach without taking into account the effect of different products will not work. A product-based RtR control approach utilized only information of previous run of the same product. Hence the effect of a product-based controller on an infrequent product would be minimal. Because the drift is the main cause of instability, it can be calibrated using an open experiment in which the fixed recipe inputs are executed and the outcome of these runs are allowed to drift. Compensations of this drift can be preprogrammed and then used as a feed-forward term in subsequent runs. In this way, the condition tool can be used to adjust the recipes of all products effectively. The advantages of this feed-forward/feedback run-to-run controller are demonstrated by simulation and experimentally.

Appendix A: Experimental Procedure

The experimental procedure consisted of the following steps:

(1) The reactor flask was put into a temperature water bath and preheated to 35 °C.

(2) A 50 mL aliquot of TEOS (tetraethoxysilane) solution in ethanol with prescribed concentration was prepared using TEOS (Catalogue No. 86578, concentration 99% (GC)) and ethanol (Catalogue No. TG-1438, concentration 99.5% (GC)) supplied by Echo Chemicals.

(3) A 50 mL aliquot of liquid was prepared by mixing a prescribed weight W_{NH_3} of aqueous ammonia (Catalogue No. 0128-3150, nominal concentration 33 wt %, Echo Chemicals) and prescribed weight of DI water with ethanol.

(4) The two solutions were added to the reactor flask, and reaction was allowed to proceed for a period of 3 h with stirring. Then 300 mL of water was added to quench the reaction.

(5) The contents were washed and centrifuged repeatedly for several times.

(6) Samples of the colloids were collected, dried, and examined under a scanning electron microscope. With the help of image analysis software, the average diameter and the standard deviation in diameter for particles were determined.

Appendix B: Simulation Model

An empirical model was developed by Bogush et al.¹⁶ to predict the diameters of SiO₂ particles in a similar experiment.

$$d = A[\text{H}_2\text{O}]^2 \exp(-B[\text{H}_2\text{O}]^{1/2}) \quad (\text{B1})$$

where d is the silica particle diameter (nm) and $[\text{H}_2\text{O}]$,

$$A = [\text{TEOS}]^{1/2}(82 - 151[\text{NH}_3] + 1200[\text{NH}_3]^2 - 366[\text{NH}_3]^3) \quad (\text{B2})$$

$$B = 1.05 + 0.523[\text{NH}_3] - 0.128[\text{NH}_3]^2 \quad (\text{B3})$$

$[\text{TEOS}]$, and $[\text{NH}_3]$ are concentrations (M) of water, TEOS, and ammonia, respectively. Although the actual results may differ slightly due to differences in reactor volume, stirrer speed, and other factors, it serves as a useful simulator for studying run-to-run control. In our experiments, the concentrations of TEOS and water are fixed. The concentration of ammonia depends on the weight of aqueous ammonia added and the concentration of aqueous ammonia stock.

$$[\text{NH}_3] = \frac{W_{\text{NH}_3} c_{\text{NH}_3}}{MV} \quad (\text{B4})$$

Figure 4 shows open loop experimental results when the weights of ammonia solution added are maintained at 4.2 and 3.3 g, respectively. Fitting these data, we developed an empirical model for decay of the concentration of aqueous ammonia

$$c_{\text{NH}_3} = 0.29 + 0.33e^{-0.52(n+3)} \quad (\text{B5})$$

In the above, n equals the number of runs performed after the original seal of a fresh bottle of aqueous ammonia stock is broken. Hence, whenever a new bottle of ammonia is used, n is reset to 1. Equations B1–B3 and eq B5 serve as the simulation of the process.

Acknowledgment

We thank the financial support provided by National Science Council, Taiwan, through the grant NSC95-2221-E-007-207.

Literature Cited

- (1) Del Castillo, E. *Statistical Process Adjustment for Quality Control*; John-Wiley and Sons: New York, 2002.
- (2) Moyné, J.; del Castillo, E.; Hurwitz, A. M. *Run-to-Run Control in Semiconductor Manufacturing*; CRC Press: Boca Raton, FL, 2001.
- (3) Qin, S. J.; Cherry, G.; Good, R.; Wang, J.; Harrison, C. A. Semiconductor manufacturing process control and monitoring: A fab-wide framework. *J. Process Control* **2006**, *16*, 179–191.
- (4) Ingolfsson, A.; Sachs, E. Stability and sensitivity of an EWMA controller. *J. Quality Technol.* **1993**, *25*, 271–287.
- (5) Zheng, Y.; Lin, Q. H.; Wong, D. S. H.; Jang, S. S.; Hui, K. Stability and Performance Analysis of Mixed Product Run-To-Run Control. *J. Process Control* **2006**, *16*, 431–443, 2006.
- (6) Firth, S. K. Just-In-Time adaptive disturbance estimation for run-to-run control in semiconductor process. Ph.D. Thesis, The University of Texas, 2002.
- (7) Pasadyn, A. J.; Edgar, T. F. Observability and state estimation for multiple product control in semiconductor manufacturing. *IEEE Trans. Semicond. Manuf.* **2005**, *18*, 592–604.
- (8) Chen, A.; Guo, R. S. Age-based double EWMA controller and its application to CMP processes. *IEEE Trans. Semicond. Manuf.* **2001**, *14*, 11–19.
- (9) Nital, S. P. Device Dependent Control of Chemical-Mechanical Polishing of Dielectric Films. *IEEE Trans. Semicond. Manuf.* **2000**, *13*, 331–343.
- (10) Telfeyan, R.; Moyné, J.; Chaudhry, N.; Pugmire, J.; Shellman, S.; Boning, D.; Moyné, W.; Hurwitz, A.; Taylor, J. A multi-level approach to the control of a chemical- mechanical planarization process. *J. Vac. Sci. Technol. A* **1996**, *14*, 1907–1913.
- (11) Congalidis, J.; Richards, J. Process control of polymerization reactors: an industrial perspective. *Polym. React. Eng.* **1998**, *6*, 71–111.
- (12) Rawlings, J. B.; Miller, S. M.; Witkowski, W. R. Model identification and control of solution crystallization processes: a review. *Ind. Eng. Chem. Res.* **1993**, *32*, 1275–1296.
- (13) Lee, K.; Lee, J. H.; Yang, D. R.; Mahoney, A. W. Integrated run-to-run and on-line model-based control of particle size distribution for a

semi-batch precipitation reactor. *Comput. Chem. Eng.* **2002**, *26*, 1117–1131.

(14) Doyle, F. J., III; Harrison, C. A.; Crowley, T. J. Hybrid model-based approach to batch-to-batch control of particle size distribution in emulsion polymerization. *Comput. Chem. Eng.* **2003**, *27*, 1153–1163.

(15) Stöber, W.; Fink, A.; Bohn, E. Controlled Growth of Monodisperse Silica Spheres in the Micro Size Range. *J. Colloid Interface Sci.* **1968**, *26*, 62–69.

(16) Bogush, G. H.; Tracy, M. A.; Zukoski, C. F., IV. Preparation of monodisperse silica particles: control of size and mass fraction. *J. Non-Cryst. Solids* **1988**, *104*, 95–106.

Received for review February 16, 2007
Revised manuscript received July 12, 2007
Accepted July 23, 2007

IE070250P