

A Comparative Study of PI and PDF Controllers for DVR Under Distorted Grid Conditions

A.Karthikeyan*, Member IEEE, D.G.Abhilash Krishna, Tejaswini A, Aeshwrya Sweta Panda, Laxmi Prasanna R,
Electrical and Electronics Engineering
National Institute of Technology Karnataka, Surathkal, India, jakarthik@nitk.edu.in

Abstract—In this paper the enhancement of power quality related issue is dealt by using Dynamic Voltage Restorer (DVR). There are mainly two aspects with DVR injection voltages one is reference generation and the other is control of DVR. Under unbalanced grid conditions negative sequence components will appear in the grid voltage and causes continuous oscillations in the estimated dq - voltages, which makes sag detection difficult with conventional SRF-PLL. In this paper Double Second Order Generalized Integrator (DSOGI) prefilter based PLL is used for extracting the symmetrical components of grid voltage and further mitigate the harmonic ripple in estimated dq quantities. Further a Pseudo Derivative Feedback (PDF) controller is proposed for single loop voltage feedback control for DVR. The robustness of the proposed controller is verified through comparative studies with PI controller using time response analysis. It is observed that the proposed PDF controller improves the system dynamics i.e., eliminates oscillations and overshoot compared to PI controller. MATLAB/SIMULINK platform is used to perform simulation studies for the 10 kV system subjected to different disturbances viz balanced and unbalanced voltage sags for both PI and PDF based controller. Finally, the experimental studies are carried out for low voltage DVR of 0.5 kVA, 100 V laboratory prototype.

Keywords—DVR; DSOGI; PDF; Voltage sag; Instantaneous Symmetrical Components (ISC);

I. INTRODUCTION

For the decades, the principal issues of electricity consumers are reliability and Power Quality. Automation and Process industries, which are highly sensitive to PQ disturbances, are heavily affected due to power quality problems. A set of FACTS devices, called Custom Power devices, are used to overcome the power quality issues from Industrial consumers.

Voltage disturbances (swell/sags) due to faults in the power systems has been in focus for a while now. Faults occurring at any voltage level can cause voltage sags for customers at medium and low voltage level as they transfer from high voltage level to low voltage levels. Hence voltage sags and swells are more common voltage disturbances at medium and low voltage levels. The DVR [1] is solid-state power converter which injects required compensation voltages in series with distribution feeder voltages. These devices are installed at Medium or Low Voltage (MV/LV) levels to compensate the

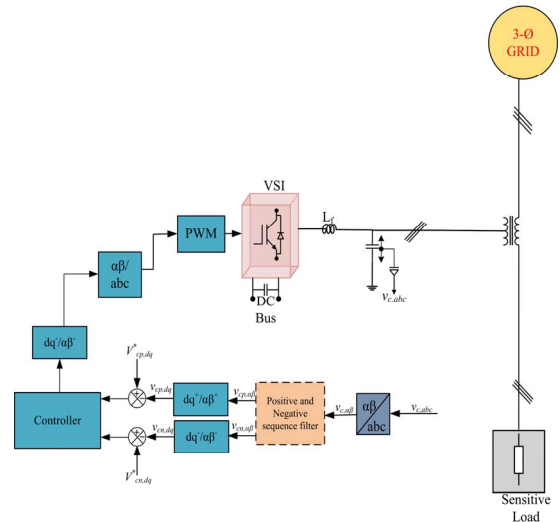

Fig.1. DVR system configuration

voltage disturbances of distribution system. When the disturbance in voltage (sag) occurs the control unit senses the voltage, calculates the sag depth and voltage to be injected. The PWM generator in control unit produces PWM switching pulses for the voltage source inverter (VSI) to generate the reference voltage to be injected. The high frequency components from the power converter output are filtered by using an LC filter. The filtered output is fed to injection transformer to inject the compensation voltage in synchronism with source voltage to maintain the load voltage at desired level.

So far, in literature sufficient work [3]-[10] has been carried out on different aspects of DVR performance. Control of DVR for fast detection and its respective compensation plays significant role. The literature presents several algorithms for control of DVR such as Open Loop Control [2], Voltage Feedback Control [3]. In single loop voltage feedback control PI controllers are mostly used because it eliminates the offset which is main drawback in P controller. But with PI controller it adds and zero $-K_i/K_p$. In this regard to overcome the issue this paper presents a PDF controller for voltage control of DVR. The transfer function of the PDF controller resembles the same characteristic equation as PI based system but with elimination of zero at $-K_i/K_p$. From the control structure point of view, the PDF differs from PI by changing the position of proportional term. Further output of conventional SRF-PLL contains double frequency components which are oscillating during unbalance grid conditions. This is because of negative sequence

components which exists in supply voltages. Thus, filtering technique is required. This paper uses DSOGI-PLL for extracting the ISC of grid voltage and exclude harmonic ripple from the dq voltages which is discussed detail in [4]. Generally, the DVR control structure consists of dual-loop as single loop control structure possess tradeoff between transient response (oscillations) and steady state response(faster). Further an attempt is made in this paper to refine the dynamic characteristics of the single loop control with PDF controller.

The rest of this paper is formulated as follows: the proposed PDF controller structure and also the PI based controller structure with their respective gain parameter calculations are discussed in section II. In Section III the PDF and PI based controller system are analyzed through time response analysis. This section also portrays the comparison studies to figure out the better scheme. In section IV Simulation results of both the controllers for the DVR system are presented. In section V the results pertaining to experimental studies are presented followed by conclusions in section VI.

II. CONTROL OF DVR

In this section, the structure of PI and proposed PDF controller for a DVR system is described. Firstly, the general structure of PDF is discussed.

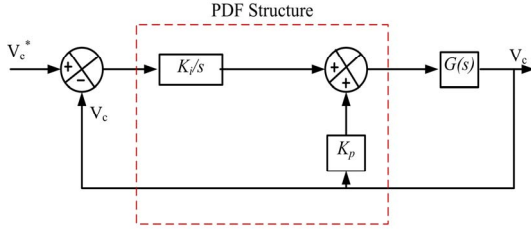

Fig. 2. Generalized PDF control system.

Fig.2 depicts the general form of PDF controller. It consists of two terms: an integral term K_i/s in the forward path, and the proportional term K_p in feedback path. In this structure, the proportional term act on output directly and the integral term acts on the difference of reference and output voltage (i.e. error signal).

A. Existing PI Controller:

The PI controller-based DVR system with filter capacitor voltage feedback is shown in Fig.3.

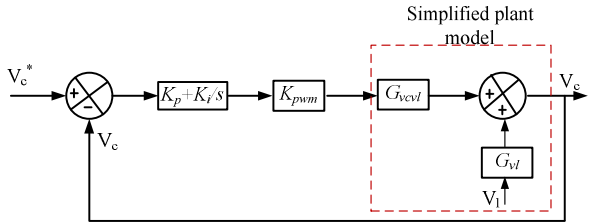

Fig.3 Block diagram of PI controller-based DVR system

The closed loop transfer function is represented by the following equations.

$$V_c = G_{V_c V_0 pi} V_c^* - G_{V_c V_0 pi} V_l \quad (1)$$

$$G_{V_2 V_0 pi} = \frac{k_{pwm} r_l \left(\frac{k_i}{s} + k_p \right)}{(s C_f r_l (s L_f + r_f) + n^2 (s L_f + r_f) + r_l) + k_{pwm} r_l \left(\frac{k_i}{s} + k_p \right)}$$

$$G_{V_2 V_l pi} = \frac{n (s L_f + r_f) \left(\frac{k_i}{s} + k_p \right)}{(s C_f r_l (s L_f + r_f) + n^2 (s L_f + r_f) + r_l) + k_{pwm} r_l \left(\frac{k_i}{s} + k_p \right)}$$

* (nomenclature is given in appendix)

The effect of $G_{V_c V_l}$ in (1) is considered as a disturbance and is neglected. Thus from (1) it can be observed that output voltage V_c tracks V_c^* as closely as possible. The controller gains are determined as follows: root locus method is used to design the proportional gain K_p . The system transfer function is given by the following equation.

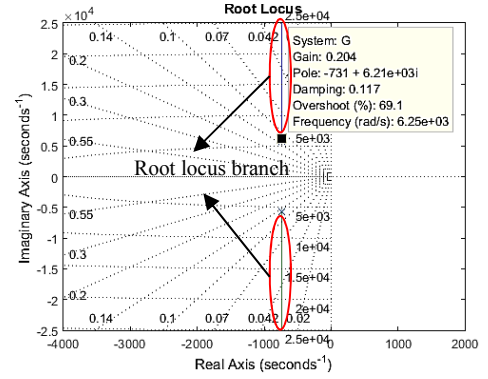

Fig. 4 Root locus of PI based system

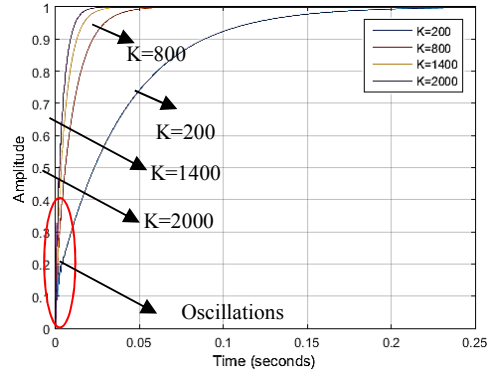

Fig.5 Step response of PI based system with different K values

$$G_{V_c V_l} = \frac{r_l}{s C_f r_l (s L_f + r_f) + n^2 (s L_f + r_f) + r_l} \quad (2)$$

From Fig.4, it is inferred that the system root locus is parallel to the imaginary axis which indicates that as the gain value increases the real part of conjugate poles remains constant. Hence, from the pole locations, K_p is chosen as 0.2 as this gain value optimizes oscillations during transients. This is from the fact that magnitude of oscillations are directly proportional to the imaginary part of conjugate poles. Further with obtained K_p value the step response of the system is analyzed for various

values of the $K(K_i/K_p) = 200,800,1400,2000$ [5]. From Fig.5 it is observed that increasing values of K produces faster response but with increased oscillations.

B. PDF controller with voltage feedback:

Fig.7 shows the simple PDF controller [5] employed for the DVR system with filter capacitor voltage feedback.

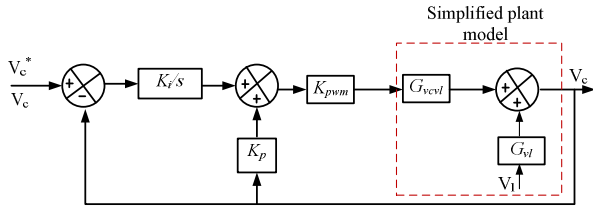

Fig7 Block diagram of PDF controller-based DVR system

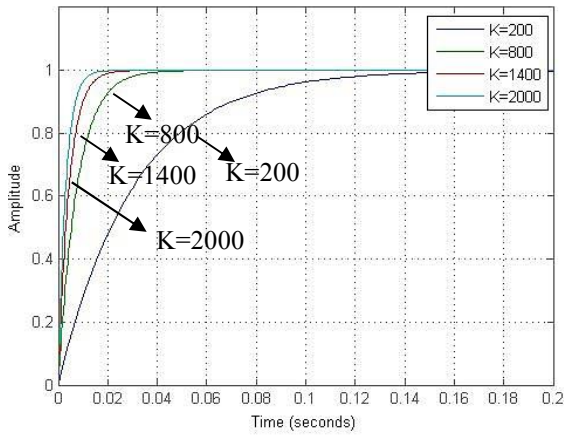

Fig.8 Step response of PDF based system

By changing the position of the proportional gain, there is a reduction in the number of zeros in the equivalent transfer function of the system. The PDF structure inherits a pre-filter feature to cancel the zeros introduced in the PI (or PID) equivalent system.

The open loop equation of the plant is given as

$$V_c = G_{V_i}V_l - G_{V_l}V_l \quad (3)$$

where

$$G_{V_i} = \frac{r_l}{sC_f r_l (sL_f + r_f) + n^2 (sL_f + r_f) + r_l}$$

and

$$G_{V_l} = \frac{n(sL_f + r_f)}{sC_f r_l (sL_f + r_f) + n^2 (sL_f + r_f) + r_l}$$

while the closed loop equation is given as

$$V_c = G_{v0V_c}V_l - G_{V_l}V_l \quad (4)$$

It is desirable that the output voltage (V_c) should track reference voltage (V_c^*) as closely as possible. V_c should normally be unaffected by load voltage V_l , at least over a generous frequency range. Since the effect of V_l is undesirable, it can be

rightly classified as a disturbance. The same procedure (as discussed in previous section) is followed for calculation of controller gains. Fig. 8 shows the step response of PDF based system where it is observed that faster response is achieved for increasing gain values and the oscillations are eliminated.

III. COMPARATIVE ANALYSIS

In this section the dynamic performance of both PDF and PI controllers which are employed for the DVR system with capacitor voltage feedback control are compared. The comparison analysis is substantiated with time response analysis for different cases viz for constant settling time and for constant rise time and the response of capacitor voltage is observed. Firstly, by maintaining the settling time parameter as constant for both the controllers, the percentage of overshoot is observed. Similarly, in the other case the settling time for both controllers are observed by maintaining the identical rise time.

A. Transient Response for constant settling time:

In this subsection, the PI and PDF controllers are tuned to give identical settling time ($T_{s1}:10.1$ ms, $T_{s2}: 8.5$ ms, $T_{s3}: 7.6$ ms) and respective step responses are presented in Fig.9(a), (b), (c). It can be observed that the PDF controller completely eliminates the overshoot for all the cases where as the PI controller exhibits an overshoot of greater than 20% for all the cases. Table 1 gives insight of PDF and PI controllers analysis for identical settling time.

B. Transient Response for constant rise time:

Fig.9(d), (e), (f) shows the transient response characteristics of PI and PDF controllers which are tuned for identical rise time ($T_{r1}:8.4$ ms, $T_{r2}:7.2$ ms and $T_{r3}:6.5$ ms). It is observed that the PDF response do not exhibit oscillations when compared with PI controller response during the transient conditions. Further the time domain parameters are tabulated in the Table 2 (appendix). It shows that the settling time of PDF controller is less compared with the respective PI controller.

Overall from the above analysis it is observed that PDF controller performs better than the PI controller during the transient response. Moreover, the PI controller exhibit oscillations whereas the PDF controller eliminates. Thus, the PDF controller exhibits good dynamic performance without affecting its bandwidth and also the capability of disturbance rejection.

Table 1: Step response characteristics for constant settling time

Settling Time(ms)	Parameter	PI	PDF
10.1ms	K_p	3.1	2.1
	K_i	1255	1370
	Overshoot (%)	28.0641	0
8.5ms	K_p	2.7	2.1
	K_i	1500	1620
	Overshoot (%)	24.0738	0
7.6ms	K_p	3	2.1
	K_i	2200	1780
	Overshoot (%)	28.0641	0

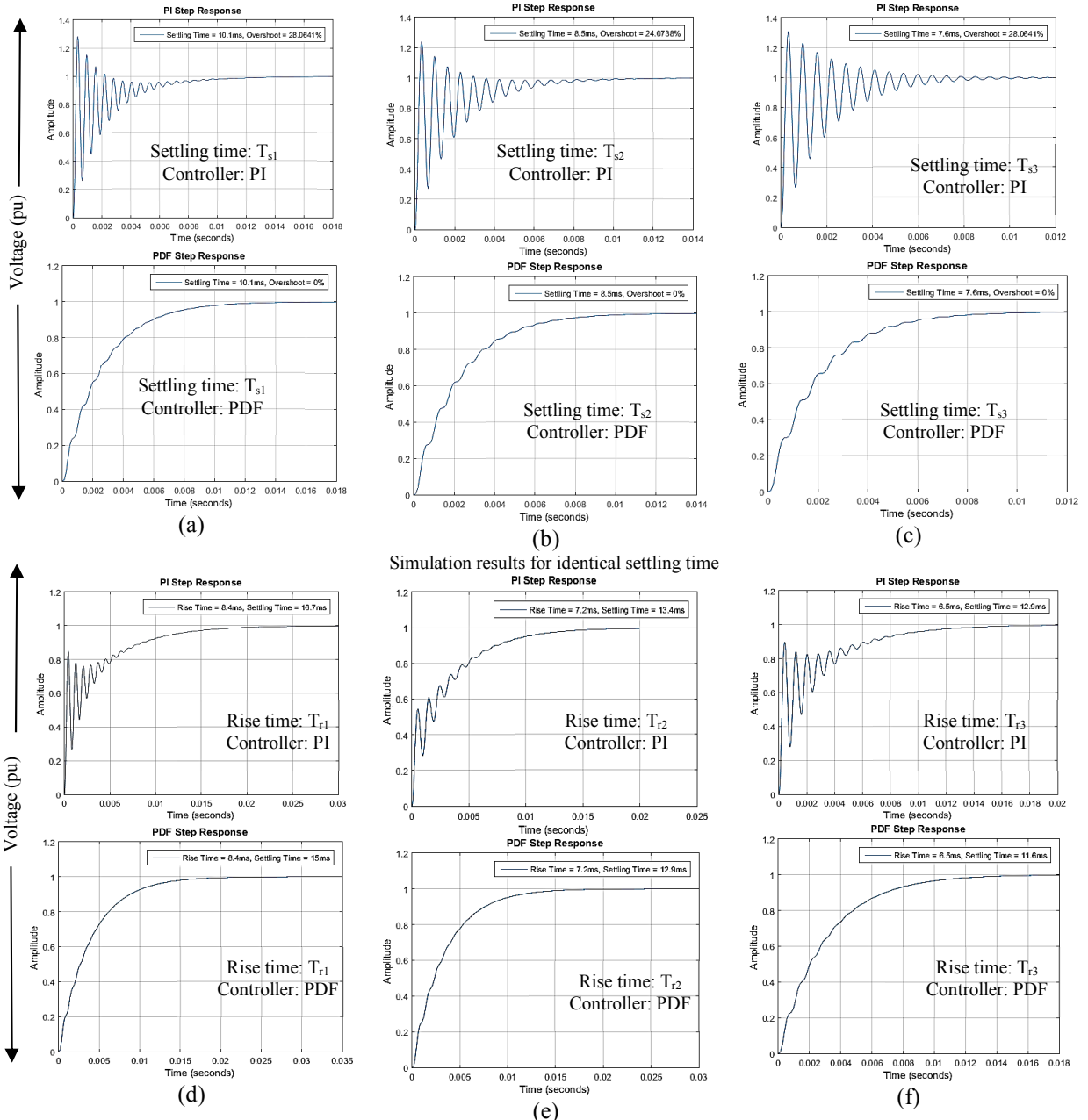

Simulation results for identical settling time
 Fig.9 Time response characteristics of PI and PDF controllers: (a)-(c) constant settling time (T_{s1} , T_{s2} , T_{s3}), (d)-(f) constant rise time (T_{r1} , T_{r2} , T_{r3})

IV. SIMULATION RESULTS

A MATLAB/SIMULINK platform is used to validate the performance of proposed PDF controller and PI controller for the different voltage disturbances mentioned in Table 3 (appendix). The simulation parameters of distribution system considered for simulation studies are tabulated in Table 4 [9].

A. Symmetric Voltage Sag:

A three-phase dip of 30% in the source voltage is generated at $t=0.08s$ for a period of 0.09s. Fig.10(a) and Fig.11(a) shows the

response of both PDF based and PI based control of DVR. The DVR injects the voltage after the detection of sag and maintains load voltage at its nominal value. It is observed that moment DVR starts injection a voltage spike (0.7 pu) is observed in Fig.11(a) (DVR voltage) using PI controller whereas the PDF controller do not produce spikes and assures smooth injection of compensating voltage which is shown in Fig.10(a).

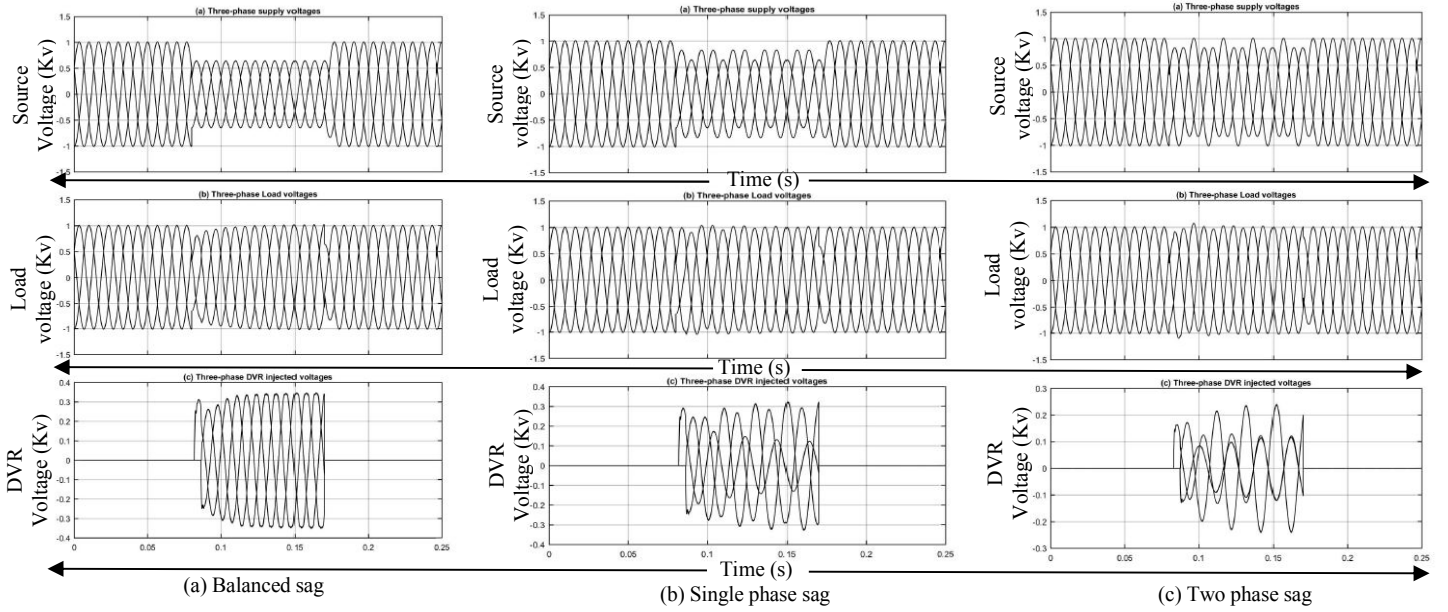

Fig.10 Dynamic Response of DVR with PDF based controller

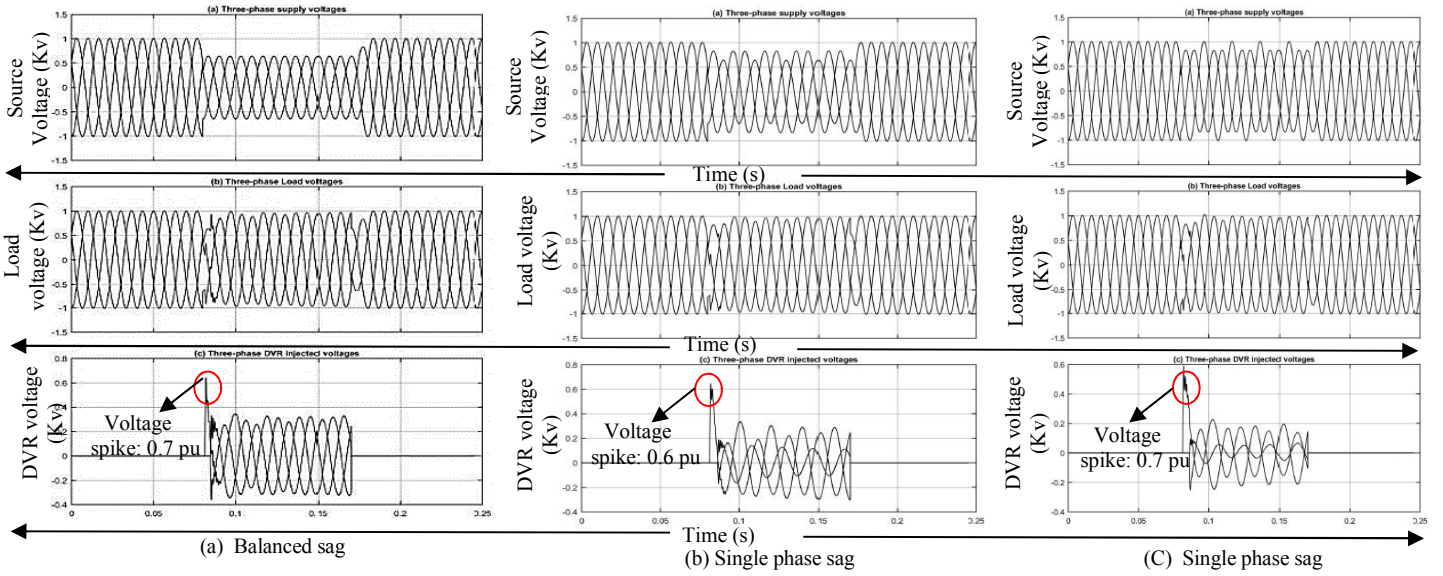

Fig.11 Dynamic Response of DVR with PI based controller

B. Asymmetric Voltage Sag:

In this section two types of line to ground faults are considered. Firstly, a two phase fault occurs in the line at $t=0.08s$ thereby reducing the voltage level in phase-b and phase-c (33%). The duration of fault lasts for 0.09s and it is cleared at $t=0.17s$. Fig.10(c) and Fig.11(c) depicts the compensation of DVR with PDF and PI controllers. It shows that when fault is initiated the DVR starts injecting the compensation voltage. During transient period, the voltage spike introduced by the PI based control system reaches 0.7pu(almost) whereas the magnitude of the PDF based system is 0.3 pu without any voltage spike. Further, a single line to ground fault occurs in the line at $t=0.08s$ and reduces the voltage level in phase-b (27%) alone whereas phase-a, phase-c

are unaffected. Fig.10(b) and Fig.11(b) shows the DVR control scheme compensating the voltage sag with PDF and PI based systems. It is clearly seen that the initial voltage magnitude of DVR raises above 0.6pu with PI based system whereas PDF based system remains within 0.3 pu. Finally, it can be concluded that from the simulation studies that compensation voltage injected by DVR with PDF based controller is free of oscillations and overshoots during transient conditions for different voltage disturbances viz symmetric and asymmetric voltage sags.

V. EXPERIMENTAL RESULT

An experimental DVR prototype scaled to 100 V is developed in the laboratory using FPGA digital processor (ALTERA,

Nomenclature:

V_c : Filter capacitor voltage; V_c^* : reference filter capacitor voltage; V_l : Load voltage; C_f : Filter capacitor; L_f : Filter Inductor; r_f : Filter resistance; n : Transformer turns ratio;

Table 3: Step response characteristics for constant rise time

Rise Time(ms)	Parameter	PI	PDF
8.4	K_p	1.2	0.805
	K_i	520	583
	Settling Time(ms)	16.7	15
7.2	K_p	0.5	0.5
	K_i	520	583
	Settling Time(ms)	13.4	12.9
6.5	K_p	1.3	1.6
	K_i	690	1020
	Settling Time(ms)	12.9	11.6

Table 4: Simulation Parameters

Device	Description	Value
Supply	Frequency	50 Hz
	AC voltage (LL rms)	10 KV
	Supply resistance	2.6 Ω
Load (Delta)		6670 Ω
Inverter	DC link voltage	600 V
	Switching frequency	3 KHz
Filter	Capacitance (C_f)	120 μ F
	Inductance (L_f)	260 μ H
Injection transformer (per phase)	Rated power (S_{tra})	67 KVA
	Primary voltage (V_1) (LL)	2900 V
	Secondary voltage (V_2)	290 V

REFERENCES

- [1] T. Wunderlin, P. Dahler, D. Amhof, and H. Gruning, "Power supply quality improvement with a dynamic voltage restorer," in *Proc. Int. Conf. Energy Manage. Power Delivery*, vol. 2, 1998, pp. 518–525.
- [2] M. Vilathgamuwa, A. A. D. R. Perera, S. S. Choi, and K. J. Tseng, "Control of energy optimized dynamic voltage restorer," in *Proc. IEEE, IECON'99 Conf.*, San Jose, CA, 1999, pp. 873–878.
- [3] Y. W. Li, P. C. Loh, F. Blaabjerg and D. M. Vilathgamuwa, "Investigation and Improvement of Transient Response of DVR at Medium Voltage Level," in *IEEE Transactions on Industry Applications*, vol. 43, no. 5, pp. 1309-1319, 2007.
- [4] M. Sriram Kasyap, A. Karthikeyan and B. Venkatesa perumal, C. Nagamani, "An Effective Reference Generation and Control of DVR using DSOGI-prefilter based PLL", in 2016 *International Conference on Circuit, Power and Computing Technologies [ICCPCT]*.
- [5] Jianguo Wang, Jiu Dun Yan, and Lin Jiang, "Pseudo-Derivative-Feedback Current Control for Three-Phase Grid-Connected Inverters with LCL Filters", in *IEEE Trans. on Power Electron.*, vol. 31, no. 5, pp. 3898-3912, May 2016.
- [6] Bingsen Wang, Giri Venkataramanan, and Mahesh Illindala, "Operation and Control of a Dynamic Voltage Restorer Using Transformer Coupled H-Bridge Converters", in *IEEE Trans. on Power Electron.*, Vol. 21, no. 4, July 2006.
- [7] Choi, S.S.; Li, J.D.; Vilathgamuwa, D.M., "A generalized voltage compensation strategy for mitigating the impacts of voltage sags/swells," in *IEEE Transactions on Power Delivery*, vol.20, no.3, pp.2289-2297, July 2005.
- [8] J. He and Y. W. Li, "Generalized closed-loop control schemes with embedded virtual impedances for voltage source converters with LC or LCL filters," *IEEE Trans. Power Electron.*, vol. 27, no. 4, pp. 1850-1861, Apr. 2012.
- [9] A. A. D. R. Perera, "Development of controllers for the dynamic voltage restorer," M.Eng. thesis, Nanyang Tech. Univ., Singapore, 2000.
- [10] J. G. Nielsen, M. Newman, H. Nielsen, and F. Blaabjerg, "Control and testing of a dynamic voltage restorer (DVR) at medium voltage level," *IEEE Trans. Power Electron.*, vol. 19, no. 3, p. 806, May 2004.

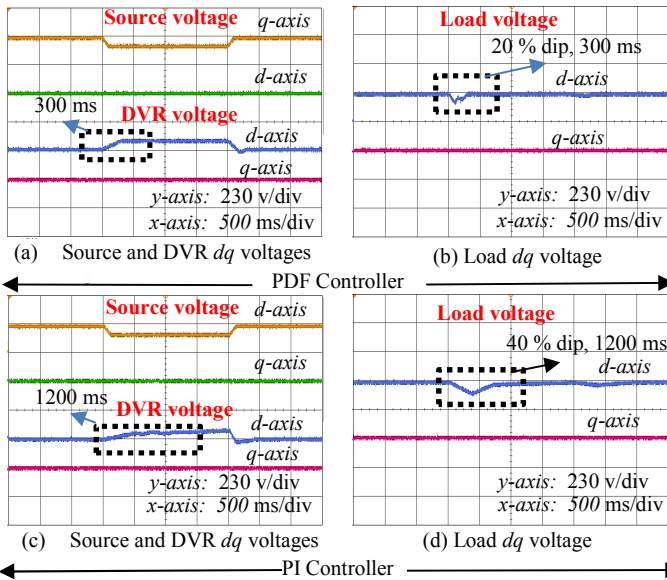

Fig.12: Experimental result: dynamic response of DVR under three phase sag cyclone-II). Fig.12 portrays the dynamic response (dq) of DVR under three phase balanced voltage sag (30%) for both PDF and PI controllers. In Fig.12(a) as the sag is initiated through three phase auto transformer which lasts for 2s. The DVR starts injecting the voltage (Fig.12(a)) and corresponding load voltage is shown in Fig.12(b). Similarly, Fig.12(c), (d) shows the response of PI controller based system. From the experimental studies it is inferred that during voltage sag period for the PI controller based system the DVR takes 1.2 s to damp out the oscillations during voltage injection. Moreover these inverter dynamics are reflected in the load voltage as a undershoot of (40%) and it takes 800 ms to reach the prefault voltage. Whereas for the PDF controller based system the oscillations are damped within 0.3 s and the respective load voltage settles to prefault value within 0.3 s. Thus, it is concluded that PDF controller based system performs better than PI controller.

VI. CONCLUSION

In this paper, PDF based voltage control has been analyzed for the DVR system to enhance the dynamic response during transient conditions. In the proposed method PI controller is replaced with PDF controller to regulate capacitor voltage. The principal advantage of PDF controller is it ensures the faster response and eliminates oscillations which is due to exclusion of additional zero in the closed-loop transfer function. The controller parameters are derived from root locus method and a comparative analysis is carried out in terms of settling time and overshoot of the respective system. The results show that PDF performs better by eliminating the oscillations and the settling time is less compared to PI controller. The simulation studies on 10 kV medium voltage DVR in MATLAB/SIMULINK shows the efficacy of the proposed PDF controller that the compensating voltage is free of oscillations during transient period while the PI controller exhibits oscillations (voltage spikes).