

STUDY OF ILLUMINATION SYSTEM IN SURFACE MINING PROJECTS AND DEVELOPMENT OF OPTIMUM LIGHTING DESIGN PARAMETERS

Thesis submitted in partial fulfillment of the requirements

for the degree of

DOCTOR OF PHILOSOPHY

By

N LAKSHMIPATHY



DEPARTMENT OF MINING ENGINEERING
NATIONAL INSTITUTE OF TECHNOLOGY
KARNATAKA, SURATHKAL, MANGALURU-575025,
KARNATAKA STATE INDIA

OCTOBER – 2017

DECLARATION

by the Ph.D. Research Scholar

I hereby *declare* that the Research Thesis entitled “**Study of Illumination System in Surface Mining Projects and Development of Optimum Lighting Design Parameters**” which is being submitted to the National Institute of Technology Karnataka, **Surathkal**, in partial fulfillment of the requirements for the award of the Degree of **Doctor of Philosophy in Mining Engineering**, *is a bonafide report of the research work carried out by me*. The material contained in this Research Thesis has not been submitted to any University or Institution for the award of any degree.

100534MN10P01, N. Lakshmipathy
(Register Number, Name & Signature of the Research Scholar)

Place: **NITK, SURATHKAL**

Date :16 - October - 2017

C E R T I F I C A T E

This is to *certify* that the Research Thesis entitled “**Study of Illumination System in Surface Mining Projects and Development of Optimum Lighting Design Parameters**” submitted by **Mr. N. Lakshmipathy** (Register Number: **100534MN10P01**) as the record of the Research work carried out by him, is *accepted as the Research Thesis submission* in partial fulfillment of the requirements for the award of degree of **Doctor of Philosophy**.

Dr.Ch.S.N.Murthy
Professor and Research Guide
Department of Mining Engineering

Dr. Mangalpady Aruna
Associate Professor and Research Guide
Department of Mining Engineering

(Name and Signature
With Date & seal)
Chairman-DRPC
(Signature with Date and Seal)

ACKNOWLEDGEMENTS

I am deeply indebted to my Guru and guide Dr.Ch. S. N. Murthy, Professor of Mining Engineering, National Institute of Technology Karnataka, Surathkal, Mangaluru, for providing me an opportunity to work under his guidance. His thorough and keen insight into the subject has provided me with many instant solutions to the problems I encountered and thus helped me to smoothly progress towards my goal. No word will be adequate to quantify his patience, tolerance and understanding. He has been a constant source of inspiration in all possible ways for successful completion of my thesis.

I would like to express my sincere gratitude to my one more Guru and guide Dr. Aruna Mangalpady, Associate Professor and former Head of the Department of Mining Engineering, National Institute of Technology Karnataka, Surathkal, Mangaluru, for his valuable guidance and constant help throughout the course of my research work. His unflinching support, suggestions and directions have helped-in the smooth progress of the research work. I am highly indebted to him. His constant encouragement and concern for my welfare will remain evergreen in my memory. I acknowledge my sincere gratitude to Dr. Harsha Vardhan, Associate Professor and former Head of the Department of Mining Engineering, National Institute of Technology Karnataka, Surathkal, Mangaluru for providing me all the facilities in the department during the time of admission for my research course. I acknowledge my sincere gratitude to Dr. M. Govinda Raj, Professor and former Head of the Department of Mining Engineering, National Institute of Technology Karnataka, Surathkal, for providing me all the facilities in the department during my research course. I acknowledge my sincere gratitude to Dr. K.V.Sastry, Professor and Head of the Department of Mining Engineering, National Institute of Technology Karnataka, Surathkal, for providing me all the facilities in the department during my research course.

I acknowledge my sincere gratitude to Dr. Subba Rao, Professor Department of Applied Mechanics and Hydraulics, National Institute of Technology Karnataka, Surathkal, has given valuable suggestions, as a RPAC member, during my research course.

I acknowledge my sincere gratitude to Dr. Parthiban.P, Assistant Professor in the Department of Electrical and Electronics Engineering, National Institute of Technology

Karnataka, Surathkal, helped and has given valuable suggestions, as a RPAC member, for my research course. I would like to express my special thanks to the professors, staff and supporting staff of the Department of Mining Engineering, NITK, Surathkal who helped me in one way or the other during my research course. My hearty thanks to my friends Harish Kumar N S, Vijay Kumar S and Abhishek Kumar Tripathi research scholars of the Department of Mining Engineering, NITK, Surathkal have helped me in one way or the other during my research course. I would also like to express my sincere gratitude to President emeritus Late Dr. T.Thimmaiah for his Inspiration and valuable support. I would also like to express my sincere gratitude to my Dynamic President emeritus Dr. T.Venkat Vardhan for his motivation and valuable support.

I would also like to express my sincere gratitude to Dr. Syed Ariff, Principal and Teaching and non teaching staff of Dr.T.T.I.T, K.G.F for their valuable support. My hearty thanks to my friends, colleagues and Mr.Ganapathi. D. Moger, Dr.T.T.I.T, K.G.F who supported and helped me throughout my research work. I would also like to express my sincere gratitude to officers and staff of M/s The SCCL (The Singareni Collieries Company Limited) Bhadradi Kothagudem District, Telengana state, for their kind cooperation during my stay and collection of Illumination data in their mines.

I would also like to express my sincere gratitude to Manager, officers and staff of limestone Mine M/s Parasakthi Cement, Guntur Dist, Andhrapradesh for their kind cooperation during my stay and collection of Illumination data in their mine.

I would also like to express my sincere gratitude to Sri K.V.Sharma, General Manager, Officers and Staff of M/s Zuari Cement, Andhrapradesh for their kind cooperation during my stay and collection of Illumination data in their mine.

I would also like to express my sincere gratitude to officers and staff of M/s Hutti Gold Mines Co. Ltd., Hutti, Raichur Dist, Karnataka, for their kind cooperation during my stay and collection of Illumination data in their mine. Thanks to anyone who ever lent me a book mentioned as a source, or sent me in an opportune direction.

It would have been impossible for me to accomplish this study without the incredible support of my family (my father, mother, sisters and brothers) and friends.

Last but not least I thank my wife V. Jhansirani, daughter Renuka, two sons Ganesh and Mukesh for their understanding and support. And above all, I am thankful to the Almighty for his grace. I am also thankful to everyone who helped me directly and indirectly during my research.

N.Lakshmipathy

ABSTRACT

Surface mining has been continuing and would continue to be an important industry in many countries. It is in fact the economic backbone of developing countries. Surface mines may cover several square kilometers of land, use large electric and diesel powered mobile type equipment, which runs almost continuously in all the three shifts. To maximize the production from such HEMM, large capacity haul trucks are used, which is common in surface mines. To ensure safe movement of men and machinery and for efficient working conditions, good efficient illumination needs to be provided during night hours. In mines a good lighting installation promotes good conditions of seeing.

In surface mines where natural light is not available, especially during night hours, artificial light is provided for better seeing, which facilitates increased production, reduces worker's fatigue, protects their health, eyes and nervous system, and reduces accidents. One major problem in surface mine lighting is continuous changing of task place, including roadways. Because of this reason it is difficult to provide any kind of long term permanent structure for illumination. Hence, the shifting of lighting installations at regular interval is very much necessary, so as to ensure required light level, as per the lighting standards specified by various regulatory bodies. Mine lighting has unique problems due to dark surrounding and low surface reflectance. To ensure safe movement of men and heavy earth moving machinery (HEMM) and for efficient working conditions, good efficient illumination needs to be provided during night hours and also during day time in case of adverse weather condition such as severe foggy atmosphere.

The important aspect of lighting design is to provide sufficient illuminance on visual tasks. The luminance level, distribution of light (i.e. uniformity) and glare are the three important design parameters, which influence the visibility during night times. However, glare is not a major problem in surface mines, as it can be easily avoided by mounting the luminaries high enough to be out of the vision field. Further, glare can also be reduced through proper angle of orientation of the luminaire.

In India, the Directorate General of Mines Safety (DGMS) recommends the standards of lighting at various parts of mine, in terms of minimum required illuminance level. However, these standards are only for the purpose of guidance. With proper layout, better visibility may be achieved even with lower illuminance level. In any lighting design uniformity ratio (U_0) is very important, which decides the distribution of light in the area. Overall uniformity ratio should be considered for design purpose, due to typical prevailing work condition in mines. Though Indian mining regulations do not mention about uniformity ratio, International Commission on Illumination (CIE), Austria, stresses upon uniformity ratio as well. CIE also suggests for the average light level instead of minimum light level. Even the Bureau of Indian Standards (BIS) emphasizes on average illumination level and uniformity ratio for traffic roadway lighting.

Scientific design of artificial lighting is very important to fulfill the lighting standards as prescribed by various regulatory bodies. The factors like type of luminaire, mounting height, pole interval, aiming angle etc., govern the design of lighting installation. While calculating illuminance level, one may wish to know its value at specific points or an average around the work place. Based on these, there are two methods of design techniques: point-by-point method and lumen method. The point-by-point method is most suitable to determine whether guidelines or regulations governing minimum illuminance or uniformity are being met.

The luminous intensity distribution of a luminaire as supplied by the manufacturer is helpful in computing the light levels at any specified points on the work place. In this thesis, a mathematical model is formulated based on the two fundamental laws of lighting design, namely inverse square law and cosine law. The developed mathematical relationship is an added contribution to the field of lighting design. The computer programme is developed using MATLAB for performing the basic illuminance calculations.

For validation of the developed programme, a telescopic light tower is fabricated, with varying tilt angle and light arm length. The arrangement is made for fixing different types of luminaries. For fixed installations, illuminance measurements are made in the field with varying design parameters, such as lamp mounting height, tilt angle and light arm length (overhang). The programme has been validated using a fabricated pole using 250W HPSV source and found to vary 2% to 5%.

Cost is another very important factor to be considered in any project. In many projects, lighting is often the last item to be considered while estimating cost. Because of this low budgetary provision, the lighting installation may not result in congenial working environment. This may decrease human efficiency and increase accidental rate thus affecting the expected performance of the project. It is therefore essential to design a proper and cost effective lighting system in the early phase of the project for better working environment. In view of this, a suitable mathematical model has been formulated and a computer programme is developed using MATLAB to estimate the total annual cost of lighting system.

To evolve optimum design parameters, a 9m width roadway is considered and horizontal illuminance level is measured at centre of the roadway for 150W HPSV source. The measurement is made by varying tilt angle from 0° to 30° , for three light arm lengths, such as 0m, 1m and 2m. The pole height is altered in five steps, such as 8m, 9m, 10m, 11m and 12m. The results of this study indicated that the luminaire is giving maximum lux level at 14° tilt angle with 0m arm length.

Using the developed design model, the lighting system is designed for a hypothetical haul road of 1km length having 12m width (which is quite common in Indian surface mines), with six different types of luminaires (of different wattages), such as CFL, FTL, HPMV, MH, HPSV and LED. Lamp mounting heights are varied at five steps, namely 8m, 10m, 12m, 14m and 16 m. Tilt angle of luminaire is kept at 14° with 0m arm length. For all the above lighting systems annual energy consumption is calculated. Further, using cost model total annual cost for all the lighting systems is computed. This study revealed that 24W LED lamps at 8m pole height spaced at 17m intervals offer the most suitable lighting system based on optimal cost considerations.

As a case study, an illumination survey is carried out in three surface mines (one limestone mine and two coal mines). The existing illuminance level at different places of mine is compared with the lighting standards specified by the DGMS. It was found that at many places illuminance level is well below DGMS guidelines. From these mines a part of lighting system was considered and it is redesigned for different types of sources, using optimum design parameters. The design has been made based on minimum illuminance levels and

overall uniformity ratio. The study revealed that, properly designed lighting system can prove to be a cost effective solution for the mine management. Benefits accrued to the mines from the lighting design are highlighted. A few guidelines on optimum design parameters for surface mine illumination have been proposed in this thesis.

The whole work has been divided into nine chapters. Chapter 1 explains the importance of illumination in surface mines. Chapter 2 deals with inter relationship between light and vision, properties of light, units of light, laws of Illumination, principles of illuminations, systems of surface mine lighting, sources of light and techniques employed for light measurement etc. Chapter 3 gives an insight on principle of haul road lighting and the parameters that hold key role in designing an illumination system, taking into account the cost parameters. Chapter 4 presents the development of computer program with MATLAB for designing illumination system and validation of developed computer program with the field data. Chapter 5 presents the cost evaluation of illumination system, formulation of cost model and development of computer program. Chapter 6 demonstrates the development of optimum lighting design parameters, such as tilt angle, light arm length, height of the pole and interval between the poles. Chapter 7 deals with the case study, wherein three mines are considered and their part of existing lighting system is redesigned with different types of sources based on optimum lighting design parameters. The energy consumption and the total annual cost are calculated for all the redesigned lighting systems. The results of the study indicates that the redesigned cost of lighting system has increased to 11.35%, 10.96% and 17%, respectively with that of existing lighting system to obtain the minimum of 0.5lux horizontal illuminance level with overall uniformity ratio of 0.3. Finally, a summarized results, discussion and conclusions as well as recommendations drawn thereof are elucidated through Chapters 8 and 9, respectively.

CONTENTS

	Page No.
CERTIFICATE	
ACKNOWLEDGEMENTS	
ABSTRACT	i
CONTENTS	v
LIST OF FIGURES	ix
LIST OF TABLES	xiv
LIST OF ABBREVIATIONS, SYMBOLS AND ACRONYMS	xix

CHAPTER 1	INTRODUCTION	1
CHAPTER 2	LITERATURE REVIEW	5
	2.1 Some Photometric Terminologies	5
	2.2 Light and Seeing	7
	2.2.1 Eyes and vision process	7
	2.2.2 Physical properties of light	8
	2.2.3 Perception of light	9
	2.2.4 Transmission, reflection and absorption of light	10
	2.2.5 Visual acuity	11
	2.2.6 Factors affecting visual environment	12
	2.2.7 Glare	13
	2.2.8 Contrast	13
	2.3 Laws of Illumination	14
	2.3.1 The Inverse Square Law	14
	2.3.2 Lambert's Cosine Law	14
	2.4 Light Measurements	14
	2.4.1 Field measurements	15
	2.4.2 Laboratory measurements	17
	2.5 Lighting Standards	18
	2.6 Sources of Lighting	22
	2.6.1 Development and classification	22
	2.6.2 Principle characteristics	23
	2.6.3 Incandescent lamps	24
	2.6.4 Fluorescent tube light	25
	2.6.5 High pressure mercury vapour lamps	26
	2.6.6 Metal halide lamps	27
	2.6.7 Low pressure sodium vapour lamps	28
	2.6.8 High pressure sodium vapour lamps	29
	2.6.9 Compact fluorescent lamp	30
	2.6.10 Light emitting diode	30
	2.6.11 Comparison of various light sources	32
	2.7 System of Surface Mine Lighting	34
	2.8 Requirements of Good Lighting	36

	2.8.1	General requirements	36
	2.8.2	Technical requirements	38
	2.8.3	Important places to be illuminated	38
2.9		Problems in Surface Mine Lighting	39
	2.9.1	Continuous moving face	39
	2.9.2	Adverse working conditions	40
CHAPTER 3		DESIGN FEATURES OF ILLUMINATION SYSTEM	41
3.1		Principle of Lighting	42
	3.1.1	Illuminance and luminance level	42
	3.1.2	Uniformity	42
	3.1.3	Glare	43
3.2		Haul Road Lighting	45
	3.2.1	Mounting height	46
	3.2.2	Spacing	47
	3.2.3	Overhang	47
	3.2.4	Tilt angle	48
3.3		Area lighting	48
3.4		Economics of Lighting	49
CHAPTER 4		COMPUTER AIDED DESIGN OF LIGHTING SYSTEM	51
4.1		Design Methodology	51
	4.1.1	Lumen Method	51
	4.1.2	Point-by-point method	52
4.2		Formulation of Illumination Design Model	52
	4.2.1	Formulation of generalized illumination design model	56
4.3		MATLAB Aided Design for Lighting System	60
4.4		Validation of Developed Computer Program	60
	4.4.1	Measurement of horizontal and vertical lux levels for single 150 W HPSV source	60
	4.4.2	Measurement of horizontal and vertical lux levels for two 150 W HPSV source	66
CHAPTER 5		DEVELOPMENT OF COST PROGRAMME	70
5.1		Cost Evaluation of Illumination System	70
5.2		Formulation of Cost Model	70
5.3		Development of Computer Program for Cost Evaluation	73
CHAPTER 6		OPTIMIZATION OF LIGHTING DESIGN PARAMETERS	76
6.1		Optimization of Design Parameters using 150W HPSV Source	76
	6.1.1	Variation of tilt angle and arm length at 8 m mounting height	77
	6.1.2	Variation of tilt angle and arm length at 9m mounting height	78

6.1.3	Variation of tilt angle and arm length at 10m mounting height	79
6.1.4	Variation of tilt angle and arm length at 11m mounting height	80
6.1.5	Variation of tilt angle and arm length at 12m mounting height	81
6.2	Optimization of Pole Interval	82
6.3	Design Based on Optimal Energy Considerations	87
6.4	Design Based on Optimal Cost Considerations	91
CHAPTER 7	DESIGN OF MINE LIGHTING	99
7.1	Design of Lighting for Mine-A	99
7.2	Design of Lighting for Mine-B	105
7.3	Design of Lighting for Mine-C	109
7.3.1	Haul road lighting	109
7.3.2	Area Lighting	114
CHAPTER 8	RESULTS AND OVERALL DISCUSSION	120
8.1	Optimization of Design Parameters	120
8.2	Design Based on Optimal Energy Considerations	121
8.3	Design Based on Optimal Cost Considerations	123
8.4	Design of Mine Lighting	124
8.4.1	Design of lighting system for Mine-A	124
8.4.2	Design of lighting system for Mine-B	126
8.4.3	Design of lighting system for Mine-C	127
8.4.3.1	Haul road lighting	127
8.4.3.2	Area lighting	129
8.4.4	Overall discussion about case study	129
CHAPTER 9	CONCLUSIONS AND SCOPE FOR FUTURE WORK	131
9.1	CONCLUSIONS AND RECOMMENDATIONS	131
9.2	SCOPE FOR FUTURE WORK	134
REFERENCES		135
ANNEXURE – I		145
ANNEXURE – II		148
ANNEXURE – III		159
ANNEXURE – IV		167
ANNEXURE – V		171

ANNEXURE – VI	202
ANNEXURE – VII	204
ANNEXURE – VIII	206
PUBLICATIONS BASED ON THESIS WORK	228
BIO-DATA	229

LIST OF FIGURES

Fig. Nos.	Name of Figure	Page No
2.1	Sectional view of human eye	8
2.2	Brightness sensitivity of eye as a function of light wavelength	10
2.3	Inverse Square Law	14
2.4	Lambert's Cosine Law	15
2.5	Digital Luxmeter	16
2.6	Accessories for holding luxmeter	17
	a Horizontal measurement	17
	b Vertical measurement	17
2.7	C- γ system of coordinates used in road lighting for the presentation of luminaire photometric data	18
2.8	General classification of electric lamps	24
2.9	Incandescent bulb	25
2.10	Construction of a linear fluorescent lamp	26
2.11	High pressure mercury vapour lamp	27
2.12	Metal halide lamp	28
2.13	Low pressure sodium vapour lamp	29
2.14	High pressure sodium vapour lamps	30
2.15	Compact fluorescent lamps	31
2.16	LED source	31
2.17	Effects of technological progressions on the efficacy of light sources	34
2.18	Effects of light intensity on performance and fatigue	36
2.19	Comparison of visual performance between two different age groups	37

3.1	The four basic conventional road lighting arrangements	46
a	Single sided	46
b	Staggered	46
c	Opposite	46
d	Twin Central	46
3.2	Street lighting features	47
3.3	Geometry and terminology used in a typical road lighting installation	50
4.1	Illuminance on a horizontal plane	53
4.2	Details of illuminance surrounding at point P	54
4.3	Flowchart of computer program	61
4.4	Fabricated light pole	62
4.5	Measured horizontal and vertical lux levels	63
4.6	Horizontal illumination levels	64
4.7	Vertical illumination levels	65
4.8	Measured horizontal and vertical lux levels with two sources	67
4.9	Horizontal illumination levels	68
4.10	Vertical illumination levels	69
5.1	Simplified flow chart for cost calculations	74
6.1	Influence of tilt angle on illuminance levels for different arm length at 8m pole height	77
6.2	Influence of tilt angle on illuminance levels for different arm length at 9m pole height	79
6.3	Influence of tilt angle on illuminance levels for different arm length at 10m pole height	80
6.4	Influence of tilt angle on illuminance levels for different arm length at 11m pole height	81
6.5	Influence of tilt angle on illuminance levels for different arm length at 12m pole height	82

6.6	a	Input design parameters for the computer programme	84
	b	Computer output for horizontal lux levels between two poles	85
	c	Output of the computer programme	86
7.1		Existing lighting system with 2x40W FTL lamps (8m pole height and irregular pole interval) in Mine-A	102
7.2		Proposed lighting system with 2x40W FTL lamps (10m pole height and 18m pole interval) for Mine-A	102
7.3		Proposed lighting system with 100W HPSV lamps (10m pole height and 20m pole interval) for Mine-A	102
7.4		Proposed lighting system with 70W HPSV lamps (8m pole height and 19m pole interval) for Mine-A	103
7.5		Proposed lighting system with 80W HPMV lamps(8m pole height and 16m pole interval) for Mine-A	103
7.6		Proposed lighting system with 70W MH lamps (8m pole height and 17m pole interval) for Mine-A	103
7.7		Proposed lighting system with 24W LED lamps at (8m pole height and 17m pole interval) for Mine-A	103
7.8		Existing lighting system with 250W MH sources (12m pole height and irregular pole interval) in Mine-B	105
7.9		Proposed lighting system with 250W MH lamps (10m pole height and 21m pole interval) for Mine-B	107
7.10		Proposed lighting system with 70W HPSV lamps (8m pole height and 19m pole interval) for Mine-B	107
7.11		Proposed lighting system with 70W MH lamps (8m pole height and 17m pole interval) for Mine-B	108
7.12		Proposed lighting system with 80W HPMV lamps (8m pole height and 16m pole interval) for Mine-B	108
7.13		Proposed lighting system with 24W LED lamps (8m pole height and 17m pole interval) for Mine-B	108
7.14		Existing lighting system with 400W HPSV sources (12m pole height and	

	irregular pole interval) in Mine-C	110
7.15	Proposed lighting system with 400W HPSV sources (14m pole height and 25m pole interval) for Mine-C	110
7.16	Proposed lighting system with 70W HPSV sources (8m pole height and 19m pole interval) for Mine-C	112
7.17	Proposed lighting system with 70W MH sources (8m pole height and 17m pole interval) for Mine-C	112
7.18	Proposed lighting system with 80W HPMV sources (8m pole height and 16m pole interval) for Mine-C	112
7.19	Proposed lighting system with 24W LED sources (8m pole height and 17m pole interval) for Mine-C	113
8.1	Bar chart showing annual energy consumption for different types of lighting systems	122
8.2	Bar chart showing total annual cost for different types of lighting systems	123
8.3	Bar chart showing total annual cost for various types of sources	125
8.4	Bar chart showing total annual cost for various types of sources	127
8.5	Bar chart showing total annual cost for various types of sources	128

LIST OF FIGURES IN ANNEXURES

Annexure No.s	Fig. Nos.	Name of Figure	Page No.
VI	1	Influence of mounting height on illuminance level at tilt angle $\theta = 0^\circ$	202
VI	2	Influence of mounting height on illuminance level at tilt angle $\theta = 14^\circ$	203
VII	1	Isolux contour for two 70W HPSV source at 19m interval and mounted at a height of 8m with 14° tilt angle	205
VIII	1(a)	Input design parameters for the computer programme (Mounting height=8m; Pole interval=21m)	206
	1(b)	Computer output for horizontal lux levels between two poles	207
	1(c)	Computer output for illumination levels and uniformity ratio	208
	2(a)	Input design parameters for the computer programme (mounting height=8m; Pole interval=22m)	209
	2(b)	Computer output for horizontal lux levels between two poles	210
	2(c)	Output of the computer programme	211
	3(a)	Input design parameters for the computer programme (mounting height=10m; Pole interval=23m)	212
	3(b)	Computer output for horizontal lux levels between two poles	213
	3(c)	Output of the computer programme	214
	4(a)	Input design parameters for the computer programme (mounting height=12m; Pole interval=24m)	215
	4(b)	Computer output for horizontal lux levels between two poles	216
	4(c)	Output of the computer programme	217
	5(a)	Input design parameters for the computer programme (mounting height=14m; Pole interval=25m)	218
	5(b)	Computer output for horizontal lux levels between two poles	219
	5(c)	Output of the computer programme	220
	6(a)	Input design parameters for the computer programme (mounting height=16m; Pole interval=23m)	221
	6(b)	Computer output for horizontal lux levels between two poles	222
	6(c)	Output of the computer programme	223
	7(a)	Input design parameters for the computer programme (mounting height=16m; Pole interval=24m)	224
	7(b)	Computer output for horizontal lux levels between two poles	225
	7(c)	Output of the computer programme	226

LIST OF TABLES

Table Nos.	Name of Table	Page No.
2.1	Illumination standards specified by D.G.M.S Circular (Legislation .3/1976)	20
2.2	Illuminance and uniformities for typical areas in surface miners (CIE 128- 1988)	21
2.3	Illumination standards specified by IS: 1944 (parts I & II)-1970	22
2.4	General characteristics of representative lamp types	32
2.5	LED compared with other conventional sources	33
2.6	Comparison between different features of CFL, LED and Incandescent bulbs	33
6.1	Illuminance levels with 8m mounting height	77
6.2	Illuminance levels with 9m mounting height	78
6.3	Illuminance levels with 10m mounting height	79
6.4	Illuminance levels with 11m mounting height	80
6.5	Illuminance levels with 12m mounting height	82
6.6	Optimum pole spacing for different types of sources	87
6.7	Optimum total annual energy consumption for different types of lighting sources	88
6.8	a Input cost parameters of pole, cable and luminaire	91
	b Input parameters w.r.t. pole and cable	92
	c Input cost parameters of cable for different rating	92
6.9	a & b Output of the cost programme for 70W HPSV source	93,94
6.10	Total annual cost for different types of sources	95
7.1	Input parameters for the programme for Mine-A	100
7.2	Output of the cost programme for Mine-A	101

7.3	a	Design parameters of existing and proposed illumination systems for Mine-A	104
	b	Annual cost of existing and proposed illumination system for Mine-A	104
7.4		Input parameters for the programme for Mine-B	106
7.5		Output of the cost programme for Mine-B	107
7.6	a	Design parameters of existing and proposed illumination systems for Mine-B	108
	b	Annual cost of existing and proposed illumination systems for Mine-B	109
7.7		Input parameters for the programme for Mine-C	111
7.8		Output of the cost programme for Mine-C	111
7.9	a	Design parameters of existing and proposed illumination systems for Mine-C	113
	b	Annual cost of existing and proposed illumination system for Mine-C	114
7.10		Details of installations of existing Area lighting system for Mine-C	115
7.11		Input parameters for the programme for existing Area lighting system for Mine-C	116
7.12		Output of the programme for existing Area lighting system for Mine-C	117
7.13		Details of installations of proposed Area lighting systems for Mine-C	117
7.14		Input parameters for the programme for proposed Area lighting system for Mine-C	118
7.15		Output of the programme for proposed Area lighting system for Mine-C	119
7.16		Total annual cost of existing and proposed Area lighting systems for Mine-C	119
8.1		Relative increase in pole spacing w.r.t increase in pole height and the wattage of the source (as obtained from Table 6.6)	121

LIST OF TABLES IN ANNEXURES

No.s	Table Nos.	Name of Table	Page No.
I	1	Luminous intensity values for different C- γ values for 70W HPSV lamp	147
II	1(a)	Computer output for single 150W HPSV source - Screen shot	148
	1(b)	Computer output for single 150W HPSV source	150
	2 (a)	Computer output for two 150W HPSV sources - Screen shot	154
	2 (b)	Computer output for two 150W HPSV sources	156
III	1(a)	Computer output for Total Annual Cost for 70W HPSV- Screen shot	159
	1(b)	Computer output for Total Annual Cost for 70W HPSV- MATLAB display	163
	1(c)	Computer output for Total Annual Cost for 70W HPSV	164
IV	1	Computer program output for area lighting with 250W LED source	167
V	1(a)	Computed (R_M) and measured (R_F) horizontal lux levels for single 150W HPSV source	174
	1(b)	Computed (R_M) and measured (R_F) vertical lux levels for single 150W HPSV source	175
	2(a)	Error analysis along 0m grid for single 150W HPSV source (for horizontal lux measurements)	176
	2(b)	Error analysis along 0m grid for single 150W HPSV source (for vertical lux measurements)	176
	3(a)	Error analysis along 1m grid (left side) for single 150W HPSV source (for horizontal lux measurements)	177
	3(b)	Error analysis along 1m grid (left side) for single 150W HPSV source (for vertical lux measurements)	177
	4(a):	Error analysis along 1m grid (right side) for single 150W HPSV source (for horizontal lux measurements)	178
	4(b)	Error analysis along 1m grid (right side) for single 150W HPSV source (for vertical lux measurements)	178
	5(a)	Error analysis along 2m grid (left side) for single 150W HPSV source (for horizontal lux measurements)	179
	5(b)	Error analysis along 2m grid (left side) for single 150W HPSV source (for vertical lux measurements)	180
	6(a)	Error analysis along 2m grid (right side) for single 150W HPSV source (for horizontal lux measurements)	180
	6(b)	Error analysis along 2m grid (right side) for single 150W HPSV source (for vertical lux measurements)	181
	7(a)	Error analysis along 3m grid (left side) for single 150W HPSV source (for horizontal lux measurements)	181

7(b)	Error analysis along 3m grid (left side) for single 150W HPSV source (for vertical lux measurements)	182
8(a)	Error analysis along 3m grid (right side) from the pole for single 150W HPSV source (for horizontal lux measurements)	182
8(b)	Error analysis along 3m grid (right side) for single 150W HPSV source (for vertical lux measurements)	183
9(a)	Error analysis along 4m grid (left side) for single 150W HPSV source (for horizontal lux measurements)	183
9(b)	Error analysis along 4m grid (left side) for single 150W HPSV source (for vertical lux measurements)	184
10(a)	Error analysis along 4m grid (right side) for single 150W HPSV source (for horizontal lux measurements)	185
10(b)	Error analysis along 4m grid (right side) for single 150W HPSV source (for vertical lux measurements)	185
11(a)	Error analysis along 5m grid (right side) for single 150W HPSV source (for horizontal lux measurements)	186
11(b)	Error analysis along 5m grid (right side) for single 150W HPSV source (for vertical lux measurements)	186
12	Sum and average values for single 150W HPSV source (for horizontal and vertical lux measurements)	187
13(a)	Computed (R_M) and measured (R_F) horizontal lux levels for two 150W HPSV source	188
13(b)	Computed (R_M) and measured (R_F) horizontal lux levels for two 150W HPSV source	189
14(a)	Error analysis along 0m grid (at left side) for two 150W HPSV source (for horizontal lux measurements)	190
14(b):	Error analysis along 0m grid (at left side) for two 150W HPSV source (for vertical lux measurements)	190
15(a)	Error analysis along 1m grid for two 150W HPSV source (for horizontal lux measurements)	191
15(b)	Error analysis along 1m grid for two 150W HPSV source (for vertical lux measurements)	191
16(a):	Error analysis along 2m grid for two 150W HPSV source (for horizontal lux measurements)	192
16(b):	Error analysis along 2m grid for two 150W HPSV source (for vertical lux measurements)	192
17(a):	Error analysis along 3m grid for two 150W HPSV source (for horizontal lux measurements)	193
17(b):	Error analysis along 3m grid for two 150W HPSV source (for vertical lux measurements)	193
18(a)	Error analysis along 4m grid for two 150W HPSV source (for horizontal lux measurements)	194
18(b)	Error analysis along 4m grid for two 150W HPSV source (for vertical lux measurements)	194
19(a)	Error analysis along 5m grid for two 150W HPSV source	195

		(for horizontal lux measurements)	
	19(b):	Error analysis along 5m grid for two 150W HPSV source (for vertical lux measurements)	195
	20(a)	Error analysis along 6m grid for two 150W HPSV source (for horizontal lux measurements)	196
	20(b)	Error analysis along 6m grid for two 150W HPSV source (for vertical lux measurements)	197
	21(a)	Error analysis along 7m grid for two 150W HPSV source (for horizontal lux measurements)	197
	21(b):	Error analysis along 7m grid for two 150W HPSV source (for vertical lux measurements)	198
	22(a)	Error analysis along 8m grid for two 150W HPSV source (for horizontal lux measurements)	198
	22(b)	Error analysis along 8m grid for two 150W HPSV source (for vertical lux measurements)	199
	23(a)	Error analysis along (At 9m from left side/0m at right side) grid for two 150W HPSV source (for horizontal lux measurements)	199
	23(b)	Error analysis along (At 9m from left side/0m at right side) grid for two 150W HPSV source (for vertical lux measurements)	202
	24	Sum and average values analysis for two 150W HPSV sources (for horizontal and vertical lux measurements)	201
VI	1	Illuminance levels for 0m, 1m and 2m arm lengths for different mounting heights at 0° tilt angle (for 150 W HPSV)	202
	2	Illuminance levels for 0m, 1m and 2m arm lengths for different mounting heights at 14° tilt angle (for 150 W HPSV)	203
VIII	1	Optimum pole spacing, E_{min} and U_o values for 250W LED sources at different pole heights	227

LIST OF ABBREVIATIONS, SYMBOLS AND ACRONYMS USED IN THIS THESIS

A	area of working plane
a	distance from the source to the point of illuminance measurement along γ -plane
ADC	annual depreciation on cable
ADL	annual depreciation on luminaries
ADP	annual depreciation on poles
AIC	annual interest on cable
AIL	annual interest on luminaries
AIP	annual interest on poles
ALL	average lamp life of a particular type
a_m	modified distance from the source to the point of illuminance measurement along γ -plane
AMC	annual maintenance cost
ARC	annual running cost
AS	Australian Standard
b	distance from the source to the point of measurement along C-plane
BH	burning hours per year of the switching mode
BIS	Bureau of Indian Standards
BL	ballast loss per luminaire
b_m	modified distance from the source to the point of measurement along C-plane
C	horizontal angle between the vertical plane along the kerb and the line joining the bottom of the pole to the point of measurement
C_m	modified horizontal angle between the vertical plane along the kerb and the line joining the bottom of the pole to the point of measurement
$^{\circ}\text{C}$	degree centigrade
CC	cable cost per kilometer
cd/m^2	candela per square meter
CFL	compact fluorescent lamp
CIE	Commission Internationale de' Eclairage
CL	cable laying cost
CMR	Coal Mines Regulations
CMRS	Central Mining Research Station
Cir.	Circular
DGMS	Directorate General of Mines Safety
d	Distance from the source to the point of measurement
E	illuminance level
ECSC	European Coal and Steel Community
E_{avg} or	average illuminance or mean illuminance level

E_{mean}	
E_h	horizontal illuminance level
E_{max}	maximum illuminance level
E_{min}	minimum illuminance level
EN	energy cost per year
F	lamp flux
FAC	fixed annual cost
F_{avg}	average value of field measured values
FTL	fluorescent tubular lamp
h	vertical height of the source from the point of measurement
HAL	halogen lamp
HEMM	Heavy Earth Moving Machinery
HID	high intensity discharge
h_m	modified vertical height of the source from the point of measurement
HPMV	high pressure mercury vapour
HPSV	high pressure sodium vapour
hrs	hours
h/yr	hours per year
I	intensity of source
$I_{(C,\gamma)}$	I - table
IES	Illuminating Engineering Society
IMF	inverse maintenance factor
IS	Indian Standards
ISLE	Indian Society of Lighting Engineers
km	kilometer
KPWDSR	Karnataka Public Works Department Schedule of Rates
KWHPR	kilowatt-hour price
KW-hr	kilowatt hour
L	light pole
LC	lamp replacement cost per year
LCL	labour cost for lamp replacement per year
LED	light emitting diode
Legis.	legislation
Lm	lumen
Lm/m^2	lumen per square meter
lm/W	lumen per watt
L_{OC}	life of cable
LP	unit price of lamp
LRC	Light Research Center
m	meter

mA	milli Amper
MARE	mean absolute relative error
MBE	mean bias error
MCL	maintenance cost per luminaire
M	maintenance factor
MH	metal halide
MSHA	Mines Safety and Health Administration
MPE	mean percentage error
MT	million tones
n	No. of samples of practical/field measured readings
N	number of lighting points
N _C	life of cable
N _L	life of luminaire
N _P	life of pole
NC	number of cleanings per annum
NL	number of lamps in the particular luminaire
N _{OL}	number of lamps in the particular luminaire
NLT	number of luminaires of a particular type
nm	nano meter
OB	overburden
PC	unit pole cost
PFC	unit pole fittings cost
PFIC	unit pole fittings installation cost
PIC	unit pole installation cost
PL	unit price of luminaire
r	inclined distance from the source to the point of measurement
R	interest rate
R ²	coefficient of determination
R _F	reading of practical/field measured values, lux
r _m	modified inclined distance from the source to the point of measurement
R _M	reading of predicted/computed output, lux
RL	labour cost per lamp replacement
Rs/-	rupee
SC	salvage value of cable
SL	salvage value of luminaire
SMRAC	Safety in Mines Research Advisory Committee
SOX	low pressure sodium vapour
SP	salvage value of pole
TAC	total annual cost
TC	initial cabling cost

TL	initial cost of luminaires
TLC	total length of cable
TNL	total number of luminaires
TP	initial cost of pole
TNP	total number of poles
<i>t</i> -stat	<i>t</i> -statistic
U	utilization factor
U _o	overall uniformity ratio
UV	ultraviolet
W	watt
WNLT	total watts per luminaire of a particular type
w.r.t	with respect to
yr	year
π	pi
ρ	reflectivity
α	tilt angle of light source with the horizontal
γ	angle between the vertical line passing through the luminaire and the line joining the luminaire and the point of illumination
γ _m	modified angle between the vertical line passing through the luminaire and the line joining the luminaire and the point of illumination
°	degree
%	percentage
∑	summation
₹	Indian National Rupee (INR)

CHAPTER 1

INTRODUCTION

A surface mine which consists of several square kilometers of land and where mining operations are carried out round the clock, systematic artificial lighting is necessary for providing safe and efficient working environment. In view of huge investment involved in mining projects, which involve powerful, large and heavy mobile equipments, good working condition during night hours for increased productivity is a necessary (Anon, 1961; Anon, 1984; Mayton et al., 1991). According to Trotter et al. (1984) and Don et al. (1948) poor lighting is one of the major causes of accidents, which can be reduced by increase in illumination level. As per Bell et al. (1972), one must light a task according to the ability of one's eyes to see and not according to the way a light source illuminates. This signifies the design of illumination system, which is very important for good vision, so that individuals may work therein with reasonable comfort. This demands the scientific design of illumination system in any lighting project.

One major problem of lighting in surface mines is continuous changing of work place including haul roads within pit limits (Bandhopadhyay et al., 1989; Bandhopadhyay et al., 1991). Because of this, it is almost impossible to provide any kind of long term permanent structure for illumination. The shifting or erection of poles at regular intervals becomes necessary so as to ensure required light level as per the specified standards recommended by the Directorate General of Mines Safety (DGMS) for minimum illuminance level for various parts of mine. But, in general, uniformity ratio is also very important in the design of effective lighting system (Bommel et al., 1980). Glare is not a major problem in surface mines, unlike for underground mines where the mounting height is restricted. In surface mines glare can be easily avoided by mounting the luminaires out of vision field and also with proper angle of orientation.

In mines, where scientific design methodology for illumination is not practiced, light

level at patches may be far below the standards. To achieve the minimum illumination standards and for economics of lighting system, illumination system should be designed considering various parameters, such as pole height, spacing between poles, tilt angle of luminaire etc. There are two methods of designing lighting system: lumen method and point-by-point method. Between these two methods point-by-point method is an accurate method of designing lighting system, in which illuminance level is computed at any point on the work place (Bommel et al., 1980).

In India, the mine lighting standard is based on the illuminance level i.e. light falling on the surface. But in reality the task or object can be seen because of light reflected from its surface (Ronald et al., 1980; Lewis et al., 1986). Therefore, the standard of lighting based upon the quality of light (illuminance) reaching a surface will give little indication of how well a task can be seen. In surface mines due to poor surface reflectivity the surrounding environment will be still darker, which may demand greater intensity of light to fall on the surface to make it clearly visible. The important aspect of lighting design is to provide sufficient illuminance on visual tasks. The illuminance level, distribution of light (i.e. uniformity) and glare are the three important design parameters, which influence the visibility during night times. However, glare is not a major problem in surface mines, as it can be easily avoided by mounting the luminaries high enough to be out of the vision field. Further, glare can also be reduced through proper angle of orientation of the luminaire.

In many projects lighting is often the last item to be considered while estimating costing. Because of this low budgetary provision, the lighting installation may result in bad working environment, which may decrease human efficiency and increase accidental rate, thus affecting the expected performance of that project. It is therefore essential to design an energy efficient and cost effective lighting system in the early phase of the project for better working environment. This is possible with proper selection of design parameters. The light design parameters are decided based on the minimum illumination standards, which can be obtained from various combinations of design features of the illumination

system. But in each case the energy consumption would be different and is the single highest cost component of any illumination system in the long run (Bright et al., 1949). Optimization of energy consumption in the illumination design would therefore reduce the overall lighting cost. But sometimes energy consumption by two lighting systems may be the same, in spite of its varied design parameters. In such cases, selection of optimum lighting design parameters is taken based on the total annual cost of entire lighting project. It comprises of fixed annual cost, running cost which includes maintenance cost. Among the said cost components, fixed annual cost mainly depends on the type of luminaire and the height of mounting (Bright et al., 1949).

Advances in the lighting technology have shown that there is tremendous scope for energy conservation in lighting system (Kurian et al., 2002). Consequently, cost effective lighting installations are very close with energy efficient lighting systems (Bright et al., 1949). Hence, a scientific approach in the illumination design would contribute to efficient lighting without much addition to the total mining project cost (Karmakar et al., 2002; Karmakar et al., 2004). In mines, in many places, light level is below the minimum required standards. This is mainly due to improper lighting design parameters, such as mounting height, pole interval, arm length and tilt angle of arm. These design parameters mainly depends upon the type and wattage of light sources. While designing lighting system one should consider all these parameters into account, which is mainly depends upon the task for which the illumination is provided. In many mines it was observed that sources are being not placed at regular intervals, because of which a uniform illumination is not obtained at the task, especially along the roadway. Further, due to irregular type and/or wattage of sources uniformity ratio is not maintained at work place, and also sometimes it creates silhouette on the place of working. In general, lamp selection is made mainly based on efficacy and suitability to each situation. For example, because of long life and efficient penetration character in dusty and foggy environment high pressure sodium vapor lamps are giving good performance in surface mine lighting. The lower

power consumption for a given amount of light, which in spite of the higher cost of the lamps, makes the overall cost of an installation less.

Keeping in view of the above observations, the present investigation is planned with the following objectives:

- To study the fundamental aspects of the lighting system in surface mining projects
- To develop a model for design of lighting systems and to evolve optimum lighting design parameters for illumination of surface mines
- To optimize the surface mine lighting systems based on energy and cost
- To replace conventional sources with LED sources based on its performance and cost

Scope of the present work

1. To develop computer program is input for MATLAB for selection of optimum lighting design parameters and cost calculation for any illumination system. The combined program together would help in the selection of cost effective lighting system satisfying the illumination standards.
2. To design a telescopic light tower with variable light arm angle and mounting height for the validation of the developed computer design program.
3. To evolve optimum lighting design parameters for illumination of identified critical areas in surface mines.
4. To carry out detailed illumination survey in surface mines as a case study and to compare the illumination levels against the stipulated DGMS standards.
5. To carry out illumination design for the case study mines utilizing the optimum lighting design parameters as obtained from the hypothetical haul road design.
6. To suggest some optimum design parameters and guidelines for haul road illumination based on the results obtained through this research work.
7. To study the feasibility of replacement of conventional sources with LED sources based on its performance and cost.

CHAPTER 2

LITERATURE REVIEW

Proper lighting is extremely important for vision that is also a challenge for lighting designers. The two fundamental interpretations of the lights that enter our eyes are made on the basis of light's physical characteristics. The wavelength determines the colour and the combination of energy level and wavelength composition is interpreted as brightness. This basic knowledge is extremely important to illumination designers so that they are aware of factors under their control that could impair or enhance these various functions and they can take appropriate measures in their designs.

2.1 Some Photometric Terminologies

Light: It is defined as the radiant energy from a hot body which produces the visual sensation upon the human eye. It is usually denoted by Q , expressed in lumen-hours and is analogous to watt-hours.

Luminous flux: It is defined as the total quantity of light energy emitted per second from a luminous body. It is represented by F and is measured in lumens or cd-sr.

Luminous intensity: Luminous intensity in any given direction is the luminous flux emitted by the source per unit solid angle. It is denoted by I and measured in candela (cd) or lumens per steradian.

The luminous intensity, which is a photometric quantity, represents the light intensity of an optical source, as perceived by the human eye. The unit candela has great historical significance. All light intensity measurements can be traced back to the candela. It evolved from an older unit, the candlepower, or simply, the candle.

Candle power: Candle power is the light radiating capacity of a source in a given direction and is defined as the number of lumens given out by the source in a unit solid angle in a given direction. It is denoted by CP.

Lamp efficiency: It is defined as the ratio of luminous flux to the power input. It is expressed in lumens per watt.

Utilization factor: It is defined as the ratio of total lumens reaching the working plane to the total lumens given out by the lamp.

Maintenance factor: It is defined by the ratio of illumination under normal working conditions to the illumination under ideal condition.

Luminaire: A luminaire is a complete lighting unit, consisting of a lamp or lamps together with the parts designed to distribute the light, position and protect the lamps, and connect the lamps to the power supply.

Illuminance : It is defined as the amount of light reaching to the ground source. It is measured in lumens per square meter or lux.

Luminance: Luminance is the amount of light reflected from a surface. The unit of measurement is candela per square meter.

Reflectance: This is the ratio of reflected luminous flux to incident luminous flux. In other words, the ratio of light energy reflected from a surface to the amount of light striking the surface.

Contrast: The relative difference in luminance between two adjacent surfaces. In other words, how bright one surface looks compared to the other or the background against which it is being viewed.

Glare: Glare is a visual sensation caused by excessive and uncontrolled brightness.

Glare is caused as a result of any excessively bright source of light in the field of view that results in the loss of visibility, discomfort, annoyance, interference with vision, or eye fatigue (Ronald et al., 1991).

There are two types of glare: disability glare and discomfort glare. Disability glare is defined as glare resulting in decreased visual performance and visibility. Discomfort caused by high and non-uniform distributions of brightness in the observer's field of view.

Horizontal Illuminance: Horizontal illuminance is the measure of brightness from a light source, usually measured in foot-candles or lumens, which is taken through a light meter's sensor at a horizontal position on a horizontal surface.

Vertical Illuminance: Vertical illuminance is the measure of brightness from a light source, usually measured in foot-candles or lumens, which is taken through a light meter's sensor at a vertical position on a vertical surface.

Uniformity Ratio: It describes the uniformity of light levels across an area. This may be expressed as a ratio of average to minimum or it may be expressed as a ratio of maximum to minimum level of illumination for a given area.

2.2 Light and Seeing

Light plays a major role in life as all activities of human beings ultimately depend upon the vision process. Light is the means of visual perception of the task and surrounding environment. Where there is no natural light, artificial light is to be provided for better viewing. Lighting designers are responsible for optimizing the visual environment taking into consideration of various parameters including energy, cost, visual performance, comfort and appearance. This section highlights some of the basic interaction between the light and human vision process.

2.2.1 Eyes and vision process

A human eye resembles a camera in structure and function. Important parts of a human eye are iris/pupil, lens and retina. The vision is either photopic (dealing with fine image details and color discrimination, due to cone cells) or scotopic (functions in dim light and no image details, due to rod cells). Eye is subject to purkinjee effect essentially dealing with shift of luminosity and ability of eye to adjust. Best sensitivity of cone cells is around 550nm (i.e. yellowish green hue) and that for rod cells is around 507nm (i.e. bluish green) as shown in Figure 2.1. Good lighting scheme should aim at prevention of defective vision, optimization of resources and improving conditions of visibility. Visibility depends on the (observer issues) size/details of object, level/quality of

illumination, contrast/color and available time. It also depends on efficacy of individual, one's eye defects, optical/physical fatigue and distraction.

The causes of fatigue could be rotating source, focusing on the source of glare, reading double impression etc. Usually after a day's work pupil is dilated (to allow in more light) a nights rest offsets fatigue (mental tiredness) due to a day's work. Visibility reduces due to eye defects and fatigues. Eye defects are caused due to aging, use or abuse. Hence, good illumination looks for producing clear and quick images. Illumination affects physiology as well as psychology, hence quality lighting is important. Factors governing illumination quality are glare, diffusion, direction/focus, composition and distribution (Mayton et al., 1987). Apart from illumination, visibility is talked in terms of visual acuity, visual efficacy, visual speed and visual health.

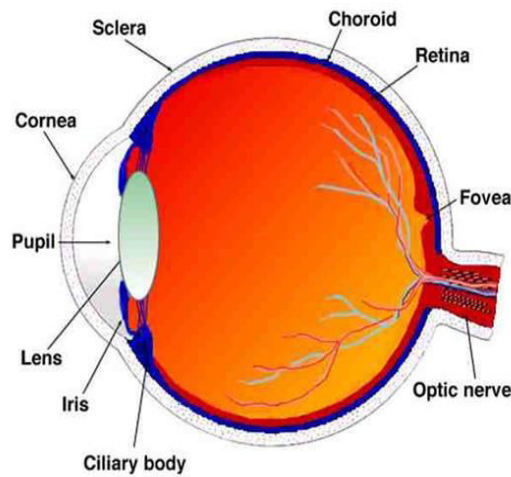

Fig. 2.1 Sectional view of human eye (*source*: LRC, 2010)

2.2.2. Physical properties of light

Light consists of photons “particle” with no mass which travel at the speed of light. They have energy and one measure of this energy is the “wavelength” of the light (Kurian et al., 2002). To a very good approximate, light travels in straight lines, and behaves much like a particle. Light may be “bent” or refracted in transparent substances, and the degree of bending, or refraction, depends upon a quantity called the refractive index. When light

is incident on a shiny, flat surface it is reflected. The reflected light leaves the surface at an angle such that the angle between the incident light and a normal to the surface is equal to the same angle for the reflected light (Dutt et al., 1960). Light is a form of radiant energy within a certain range of wavelengths, capable of stimulating the eye (Homes et al., 1975).

It travels through space from its point of origin in all directions as a cyclical wave pattern. When the body is red hot, the wavelength of the radiated energy will be sufficiently large and the energy available is in the form of heat. When the temperature increases, the body changes from red hot to white hot state, the wavelength of the energy radiated becomes smaller and smaller and enters into the visible range. Ever since Newton, it is known that different wavelengths correspond to different colours the "spectral colours" (Ginhorn et al., 1958). Visible light has wavelength extending from 380 nm to 760 nm. Wavelengths larger than 760 nm or shorter than 380 nm stimulate very little or no response to the eye.

2.2.3 Perception of light

Good lighting solutions for households require a consideration of design, lighting quality and energy efficiency aspects. To understand the requirements for good lighting it is important to consider the perception of light by the human eye and body (Dutt et al., 1960). The visual perception of the eye is restricted to the range between approximately 400nm and 700nm. Figure 2.2 shows the spectrum we are able to see. The sensitivity of the eye is different for different wavelength, with highest sensitivity for blue light (around 450nm) and red (around 650nm) (Kurian et al., 2002). The eye does not respond equally to all the wavelengths in the visible range. The CIE has defined an 'average eye' corresponding to the 'spectral luminous efficiency curve' as shown in Figure 2.2 Maximum visibility is for about 550 nm, corresponding to yellow light. 'Brightness' is a subjective evaluation of luminance. It depends both on the luminance level of the surface as well as the luminance level of the surrounding. In dark surrounding low luminance surface also may appear to be dazzling bright.

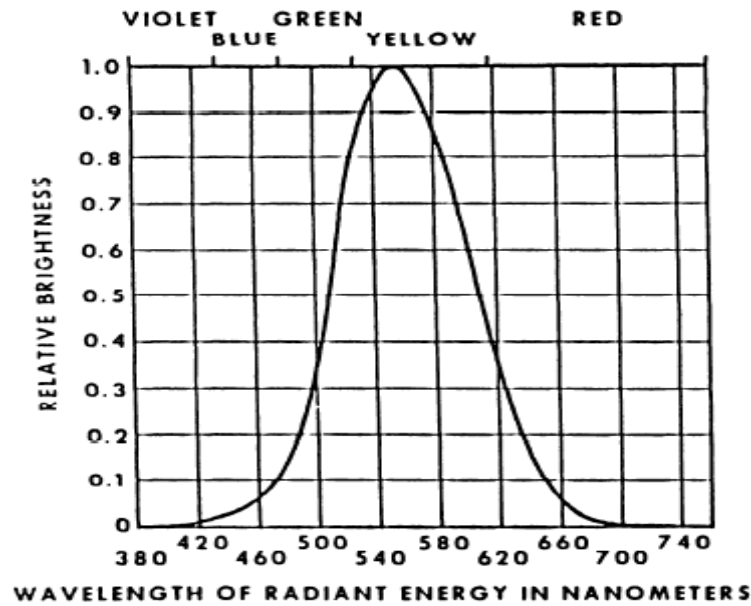

Fig. 2.2 Brightness sensitivity of eye as a function of light wavelength (*source*: Lewis, 1986)

2.2.4 Transmission, reflection and absorption of light

When light encounters an object, it is partly transmitted, partly reflected and remaining is absorbed by the object. These three ratios - transmittance, reflectance and absorptance can be used to quantify in what proportion light energy striking on a given material is distributed. Transmission of light through a medium is affected by various properties of that medium. Light can be controlled by using a material with certain transmission capabilities to cause scattering. This is known as diffusion. The dichroic reflector, an example of this type of medium, is used in headlights of some heavy vehicles to reflect a beam of visible light forward but transmit infrared wavelength backwards (Lewis et al., 1986). Diffusion is extremely important in the design of lighting systems for visual comfort i.e. not much of glare problem. The effect of diffusion is to make the light sources appear larger and hence less bright to cause any dazzling light. Reflected light is that part of the incident light, which does not penetrate through object, rather it bounces off the surface. It is this reflected light that helps in the process of viewing an object (Roberts et al., 1962). Luminance of the surface is dependent on the amount of light striking the surface and the amount of light being reflected back to the eye.

For diffusing surfaces,

$$L = \frac{\rho \times E}{\pi} \quad (2.2)$$

where,

L- luminance of surface, cd/m^2

E - illuminance falling on surface, lm/m^2

ρ = reflectance of surface, and

$\pi=3.142$ [The constant π (in steradian) is needed because of the way in which SI units are defined]

Objects distribute reflected light depending upon texture of the surface(Lewis et al., 1986). The ratio of the reflected light and incident light is called reflectance. The reflectance is expressed as a number less than one, or reflection factor expressed as a percentage (Bell et al., 1972; Zijl, 1995). In illumination design it is very important to evaluate the proportion of light the environment reflects as well as its distribution. There are various types of reflection namely, specular reflection, diffuse reflection, spread reflection and combination of the above of which diffuse reflection is always desirable for general illumination (Bommel et al., 1980).

In general, colour is a result of absorption of light. If an object selectively absorbs light at certain wavelengths, while allowing other wavelengths to be transmitted or reflected, the object is said to have discriminant absorption properties. Thus a particular surface may have a different reflection or transmission factor for every different colour. The discriminant absorption properties create wavelength imbalances of the reflected or transmitted light and give rise to the sensation of various colours in eye vision. This has impact on the selection of artificial light sources where colour discrimination is necessary.

2.2.5 Visual acuity

The ability of the eye to see fine details is termed as visual acuity (Trotter et al., 1982). It

is defined as a measure of the ability of the eye to distinguish minute details of any task (Ronald et al., 1980). Visual acuity primarily depends upon the size of the object, its contrast with the background, luminance of the surface and time available to see the task. Size is the most generally recognized and accepted factor in seeing. By bringing the object closer to eye, the visual angle is increased, making the object clearer (Ronald et al., 1980). When lighting is poor the time required to 'see accurately and act quickly' increases and one cannot react to a danger instantaneously. Visual acuity increases with the contrast. Generally a high illumination results in higher acuity and it reaches a maximum at about 1600 cd/m^2 luminance level (Trotter et al., 1984). Since lighting engineer has little or no control over size and time, the ability to see details is dependent on task contrast and background luminance. Visual acuity is better with a monochromatic light source than with a full spectrum or broken spectrum source. Several researchers have shown that in order to maintain a given degree of visual acuity in all age groups. The illumination on the task for the older groups must be progressively higher than that for the younger groups (Trotter et al., 1984).

2.2.6. Factors affecting visual environment

Levels of illumination are only one of the factors that determine the quality, and hence safety, of a visual environment (Crooks at al., 1981; ECSC, 1990; IES, 1993). In coal mining, other factors that have been identified as affecting the overall quality of the visual environment are:

- Inherent vision of the mine population
- Low surface reflectance, usually less than 5%, which almost eliminates secondary reflections and indirect lighting
- Suspended dust and water vapour cause backscattering reducing apparent illuminance
- Mounting height restrictions and job tasks place the luminaries in the worker's direct line of sight causing glare

- Mounting positions restrict the size, location and light distribution of the luminaries
- Luminaries must meet the safety requirements for use in hazardous atmospheres
- Inherent vision of the workforce population
- Low surface reflectance of rough, darkly coloured rock, which severely limits secondary reflections and indirect lighting
- Suspended dust and water vapour cause back scattering thereby reducing apparent illuminance and deposits of dust on brightly painted, potentially hazardous machinery, reduce their reflectance and, hence, their visibility
- Reduction of effective illuminance by protective eye wear

2.2.7 Glare

Glare is not a major problem in surface mines, unlike in underground mines where the mounting height is restricted. To decrease glare, it is better to have lower powered lights with small distances between them, than to have high powered lights far apart (Baines et al., 1972; Trotter et al., 1982). The following are the ways to reduce glare in the mining industry:

- Using several small low-intensity light fixtures rather than one large high-intensity light fixture
- Using light fixtures that diffuse or concentrate light well. Indirect light fixtures or direct light fixtures with parabolic louvers are two possibilities
- Covering bare bulbs with louvers, lenses or other devices to control light
- Increasing the brightness of the area around the glare source
- Using adjustable local lighting with brightness controls
- Positioning light fixtures to reduce reflected light that is directed toward the eyes

2.2.8. Contrast

In terms of providing a safe and efficient visual working environment, lighting levels do not address the problem fully. Detecting the presence of a potential hazard is probably the most common and also the most critical visual task in terms of ensuring safety (for

example, the need for drivers to see pedestrians or other obstructions, the need for pedestrians to see slip, trip, fall hazards etc.). However, with more light the eye can see more detail, hence less contrast is required (Bell et al., 1982; Best et al., 1982).

2.3 Laws of Illumination

2.3.1 The Inverse Square Law

The intensity of illumination produced by a point source varies inversely as square of the distance from the source to the point of measurement as shown in Figure 2.3.

$$E = \frac{I}{d^2} \quad (2.1)$$

Where, I- Intensity of light, lumens/steradian or candle,

d- Distance from source, m

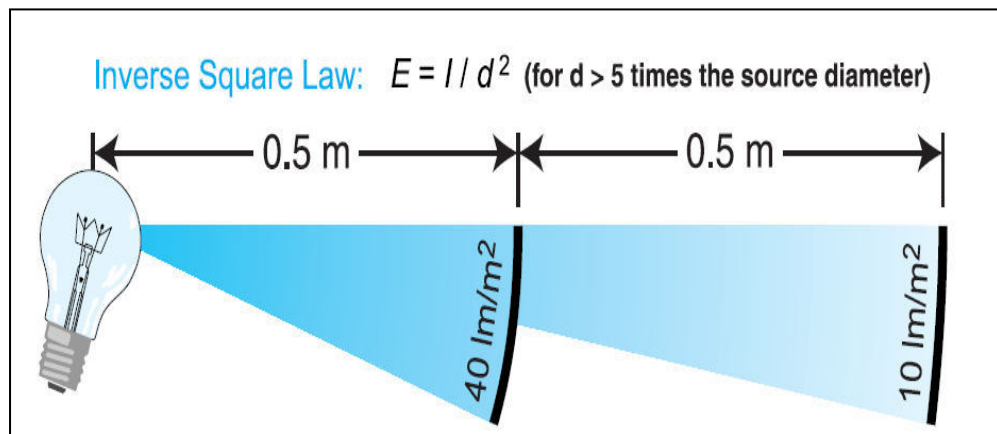

Fig. 2.3 Inverse Square Law (source: LRC, 2000)

2.3.2 Lambert's Cosine Law

The illumination at any point on an inclined surface is directly proportional to the cosine of the angle between the normal to the surface at that point and the direction of the luminous flux as shown in Fig.2.4.

2.4 Light Measurements

The light measurements fall into two categories: field measurements and laboratory measurements. Field measurements are made to check the quality characteristics of the

installation and suitability of prevailing lighting conditions. In laboratory measurements, performance characteristics of luminaires, particularly the luminous intensity distribution curve, denoted by I, is studied by photometric measurements with the help of goniophotometer.

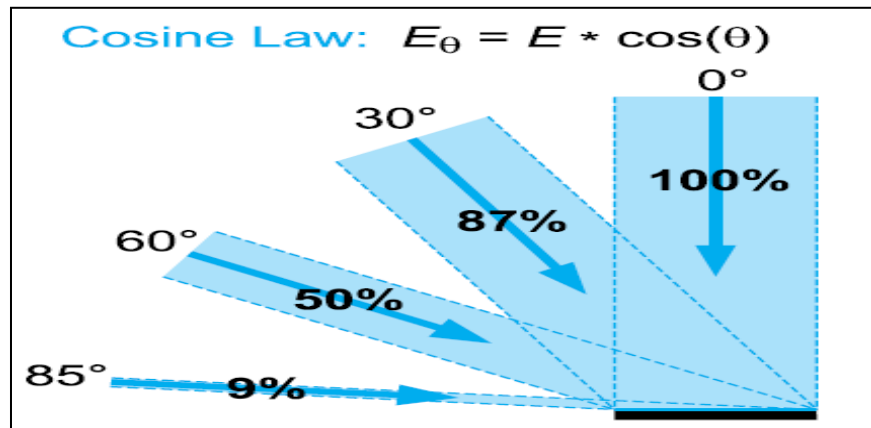

Fig. 2.4 Lambert's Cosine Law (Source: Philips Lighting Manual, 2009)

2.4.1 Field measurements

A portable instrument called light meter or luxmeter is used to measure illuminance which is shown in Figure 2.5. It consists of a photocell that receives light and converts it into an electric signal that is conditioned through an electrical circuit and is displayed on a visual meter scaled in lux (Lewis et al., 1986). The meter reading is proportional to the light energy level received by the photocell. Instruments of this kind commonly measure from 1 lux to 20,000 lux. More sensitive types are also available for taking reading in precision measurements. Sensors are of silicon diode type or selenium cell type. For accurate measurements, the meter which has been cosine and colour corrected should be used. The cosine correction takes care for the effects of light falling on the cell at oblique angles. Colour correction is necessary in order to match the spectral sensitivity of the average human eye as defined by CIE (Trotter et al., 1982; Anon et al., 2004). As a general rule luxmeter should be calibrated every two years.

The initial checks, which should be carried out before commencing any field measurements, are:

- Zero setting of the scale, and
- Voltage check of the battery.

It is a good practice to carry a spare battery if the survey continues for a long period. An installation of discharge or fluorescent lamps should be switched on at least half an hour before taking measurements to allow the lamps to glow fully. Horizontal illuminance is measured by holding the meter flat on the ground, if the work is performed down to floor level (Lewis et al., 1986). The working plane is usually taken to be 0.85 m for work benches or 0.72 m for desk top height unless the main plane of the work is known to be some other height above floor level (BIS, 1966; Anon et al., 2004). A support for the luxmeter may be used to ensure the correct measuring height during survey. A single pole having quadruped base with a small platform at the top is used to support and hold the meter flat. Vertical illuminance is measured keeping the sensor of the light meter vertical in a single orientation (Lyons, 1981). Figure 2.6 shows accessories for holding luxmeter during measurement of horizontal and vertical illuminance levels.



Fig. 2.5 Digital Luxmeter

A light meter indicates the illuminance at the point of measurement only, not the average in the space. To find the average illuminance over an area, the surface to be surveyed is divided into a number of equal areas which should be as nearly square as possible, the

size of which depends upon the area of survey and the required accuracy (Anon et al., 2004). In another system, a single reading is taken at the centre of each grid area to get the average illuminance. Field measurement procedure is discussed in detail in Bureau of Mines Information Circular of 1976 (Anon et al., 1976). The illumination measurements on and around surface mining machines is demonstrated by Mine Safety and Health Administration (MSHA), Bureau of Mines, United States (Hottinger et al., 1982).



Figure a: Horizontal measurement



Figure b: Vertical measurement

Fig .2.6 Accessories for holding luxmeter

2.4.2 Laboratory measurements

There are four fundamentally different laboratory techniques available for determining the complete luminous intensity distribution of a luminaire (Bommel et al., 1980). The manufactures supply the results of measurement by making use of (C, γ) an appropriate system of coordinates. For conventional road lighting luminaries, the C - γ system is the most favored one, which is shown in Figure 2.7. In this system 'C' is a vertical plane passing through the tilt axis of the luminaire. In general, tilt axis is parallel to the curb of the road. 'C' is measured on horizontal plane from the road kerb (also spelt as 'curb' in American English) to the line joining the base of pole and the point of illumination. The range for angle 'C' varies from 0° to 360° . The angle ' γ ' is measured on vertical plane. It is the angle between the vertical line passing though the luminaire and the line joining the

luminaire and the point of illumination. The angle ' γ ' varies from 0° to 180° . For general purpose use, the measured luminous intensity values are presented in the form of polar curves or in an isocandela diagram. For the purpose of computer calculations, the measured luminous intensity distribution is given in a digital form in a luminous intensity table for various C and γ values. The CIE recommends that tables giving the necessary intensities termed as I-tables are drawn up according to standard formats (CIE, 1973). Intensity values for any C- γ combinations other than the table values can be approximated by interpolation (Anon et al., 1993).

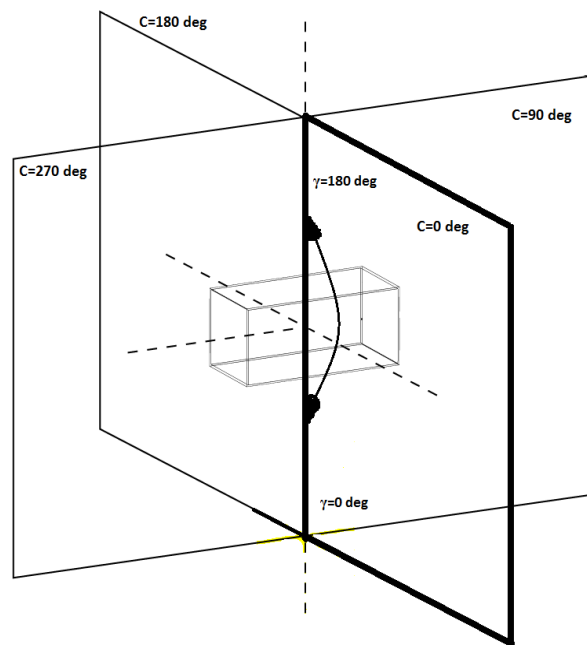

Fig. 2.7 C- γ system of coordinates used in road lighting for the presentation of luminaire photometric data (*source: Philips, 2004*)

2.5 Lighting Standards

The International Commission on Illumination (CIE), Austria, is involved in the development of guidelines for surface mine lighting. Some works by other agencies have been carried out before and around 80s. In India, the Central Mining Research Station (CMRS), Dhanbad, conducted an illumination survey in 1961, which was extended in 1962 (CMRS 1963; Kumar et al., 1966). Based on these studies, some recommendations were made for desirable illumination levels for Indian coal mines in the year 1966. But,

this work was restricted to underground mine lighting only.

The Illuminating Engineering Society of India was established in 1954. But, it came into existence in a big way only from 1983 when it was registered under the Societies Registration Act in 1984 as the Indian Society of Lighting Engineers (ISLE), Mumbai. The ISLE represents actively in the sectional committees of the Bureau of Indian Standards and helps in the preparation of National Lighting Code (Radhakrishna et al., 1999). In 1981, the CIE began to focus attention on illumination standards for surface mining by establishing a program to formulate recommendations for opencast lighting standards (Mayton et al., 1987). One of the members of ISLE became the Chairman of CIE Technical Committee 4.10 in 1987, and has brought out the CIE Guide to the lighting for surface mines. But these guidelines are not approved by the Indian mining regulatory body.

In India provisions are made regarding mine lighting under Chapter XIII of The Coal Mines Regulations (CMR) 1957; (Kaku et al., 1957). As per Regulation no. 151(1), it is required to provide adequate general lighting arrangement during working hours at every opencast working where persons have to work. Further, under Regulation no. 154(2) (b), the Chief Inspector of Mines (CIM) is authorized to prescribe the standards of lighting to be provided by notification in the official Gazette. In this context standards are prescribed for surface mine illumination by circular (Legislation) 1/1976 and circular (Legislation) 3/1976 for coal and metalliferous mines, respectively (DGMS 1976). Table 2.1 represents the illumination levels in various parts of the mine recommended by D.G.M.S Circular (Legislation.3/1976). The illumination levels mentioned here are rather low and are the minimum illumination level requirements under ideal working conditions.

The Commission Internationale de L'Eclairage (CIE) i.e. the International Commission on Illumination brought out the guide to the lighting for surface mines (CIE, 1988) in the year 1987, which specifies the average illuminance level along with overall uniformity ratio at critical areas. Table-2.2 shows the lighting standards in surface mines, as recommended by CIE. The Indian Standard (BIS, 1991) code of practice for lighting of

public thoroughfares, cite the average level of illumination with uniformity ratio as given in Table 2.3. In this table, the 'transverse variation of illumination' is given as the ratio of minimum to maximum illuminance across the roadway width.

Table-2.1: Illumination standards specified by D.G.M.S Circular (Legislation .3/1976)

Sl No.	Place/Area to be illuminated	Manner in which it is to be illuminated	Minimum standard of illumination (lux)	Plane/level in which the illumination is to be provided
1	General working areas as determined by the manage in writing	-	0.2	At the level of surface to be illuminated
2	Work place of Heavy Machinery	So as to cover the depth and height through which the machinery operates	5.0 10.0	Horizontal Vertical
3	Area where drilling rig works	So as to illuminate the full height of the rig	10.0	Vertical
4	Area where bulldozer or other tractor mounted machine works	-	10.0	At the level of the crawler tracks
5	Places where manual work is done	To be provided at level of the surface on which such work is done	5.0 10.0	Horizontal Vertical
6	Places where loading, unloading or transfer, loading of dumpers, trucks or train is carried on.	-	3.0	Horizontal
7	Operators cabins of machines of mechanisms	To be provided up to a height of 0.8 meters from floor level	30.0	Horizontal
8	At hand picking points along a conveyor belt	To be provided up to a distance of not less than 1.5 meters from the picker	50.0	On the surface of the conveyor belt.
9	Truck haulage roads	To be provided at the level of the road	0.5 to 3.0	Horizontal
10	Rail haulage track in the pit	To be provided at level of the rail heads	0.5	Horizontal
11	Roadways and foot paths from bench to bench	-	3.0	Horizontal
12	Permanent paths for use of persons employed etc.	-	1.0	Horizontal

Table-2.2: Illuminance and uniformities for typical areas in surface mines
(CIE 128 - 1988)

Sl.No.	Area	Maintained average illuminance (lux), E_{avg}	Uniformity Ratio	
			E_{min}/E_{avg} not less than	E_{max}/E_{min} not greater than
1	Slope (Excavating area)			
a)	On the vertical mine face, with local lighting by machines	500	0.40	5
b)	General lighting	100	0.40	5
c)	Drilling point	1000	0.50	3
2	Piling Waste Yard			
a)	On the vertical waste surface, with Local lighting by machines	200	0.25	10
b)	General lighting	30	0.25	10
3	Unload Coal Yard	10-20	0.25	10
4	Haul Road (Permanent sections)	30	0.30	-
5	Enclosed Belt Conveyer for exterior Use –Walkway	5 -10	0.30	-
6	Open Belt Conveyor - Walkway	50	0.30	-
7	Open Belt Conveyor in corridor			
a)	On belt	50-100	0.30	-
b)	On floor	5 -10	0.30	-
8	Coal Transfer piling Yard			
a)	On belt conveyer of bucketwheel	100	0.30	-
b)	Near the bucket	200	0.25	10
c)	Stock Yard	10-20	0.25	10
9	Mineral Material Loading Railway Station			
a)	Hopper, to see the mined material falling	1000	-	-
b)	General lighting in the loading area	200	0.40	8
10	Control room	300-500	0.50	-
	Stairs	30	-	-
11	Electronic Track Scale	100	0.40	5
12	Coal Handling Plant			
a)	On floor	100	-	-
b)	Stairs, Walkways, places to be inspected etc.	50	-	-
13	Central Control office			
a)	On the working table	500	0.80	-
b)	On the vertical surface of Panels	200	-	-
14	CPU Room			
a)	On the working table	300	0.70	-
b)	On the vertical surface of cabinets	150	-	-
15	Main Power Distribution Room	150	0.50	-

In 1988 in the VII Conference on Mines Safety held in New Delhi the importance of lighting was discussed and stressed in the succeeding circulars of DGMS (DGMS, 1992; DGMS, 1995). The lighting standards for interior illumination i.e. within surface buildings have been governed by the Indian Standard 3646 (Part - 1) (BIS, 1966).

Table-2.3: Illumination standards specified by IS: 1944 (parts I & II)-1970

CLASSIFICATION OF LIGHTING INSTALLATION AND LEVELS OF ILLUMINATION				
Classification of lighting installation	Type of road	Average levels of illumination on road surface (lux)	Minimum/average illumination	Transverse variation of illumination (%)
(1)	(2)	(3)	(4)	(5)
Group A1	Important traffic routes carrying fast traffic	30	0.4	33
Group A2	Other main roads carrying mixed traffic, like main city streets, arterial roads, throughways, etc.,	15	0.4	33
Group A3	Secondary roads with considerable traffic like principal local traffic routes, shopping streets etc.	8	0.3	20
Group A4	Secondary roads with light traffic	4	0.3	20

2.6 Sources of Lighting

2.6.1 Development and classification

In 1861, the first project of a mining electric lamp was worked out (Peretiatkoniez et al., 1982). The carbon arc lamp was the first electric light to be used successfully in European mines in 1878. A tremendous breakthrough in lighting technology occurred when the incandescent filament lamp was developed by Thomas Alva Edison in the United States. It was the first practical light source, which did not consume any fuel. By 1879 Edison had developed a practical incandescent lamp consisting of carbon filament enclosed in glass globe from which the air had been removed to a negligible pressure. It was introduced in Matylda Colliery in Swietochlowice. In the year 1911, tungsten

filaments replaced these carbon filaments, which was another breakthrough in mine lighting. Later the invention of mercury fluorescent lights set a new trend in lamp technology. Fluorescent lighting was first used in the United Kingdom in 1947 (Trotter et al., 1982). Thereafter the invention of new generation high intensity discharge (HID) lamps changed the scenario of mine lighting, especially surface mine lighting.

Discharge lamps may be further grouped according to whether the gas is contained at high or low pressure, with sub-divisions within each group according to the type of gas employed and the presence or absence of a fluorescent coating on the inner wall of the lamp envelope. The combination of these three factors determines the type of light emitted. A broad classification of electric lamps is shown in Figure 2.8.

2.6.2 Principle characteristics

The principle characteristics of light sources are:

- Luminous flux - Time rate of flow of light expressed in lumens (lm)
- Luminous efficacy - Ratio of the luminous flux emitted by a lamp to the power consumed by it expressed in lumens per watt (lm/W)
- Lamp mortality - Usually expressed as the number of operating hours elapsed before a certain percentage of the lamps fail
- Lumen depreciation - Percentage of the original luminous flux after a certain number of operating hours given by lumen depreciation factor
- Colour appearance - The lower the colour temperature, the more reddish the source, the higher the colour temperature, the more bluish the source
- Warm-up time
- Re-ignition time
- Whether or not ballast and / or ignitor is needed

Lamp selection is based on efficacy and suitability to each situation (Hottinger et al., 1982). In general, discharge lamps have a higher efficacy than that of incandescent lamps and their life is considerably longer. Some form of external ballast is necessary for

discharge lamps, with the sole exception of the blended light lamp. Unlike the incandescent lamp, most discharge lamps need a certain warm-up time before full light output is reached. Re-ignition immediately after switch off is not instantaneous for certain types.

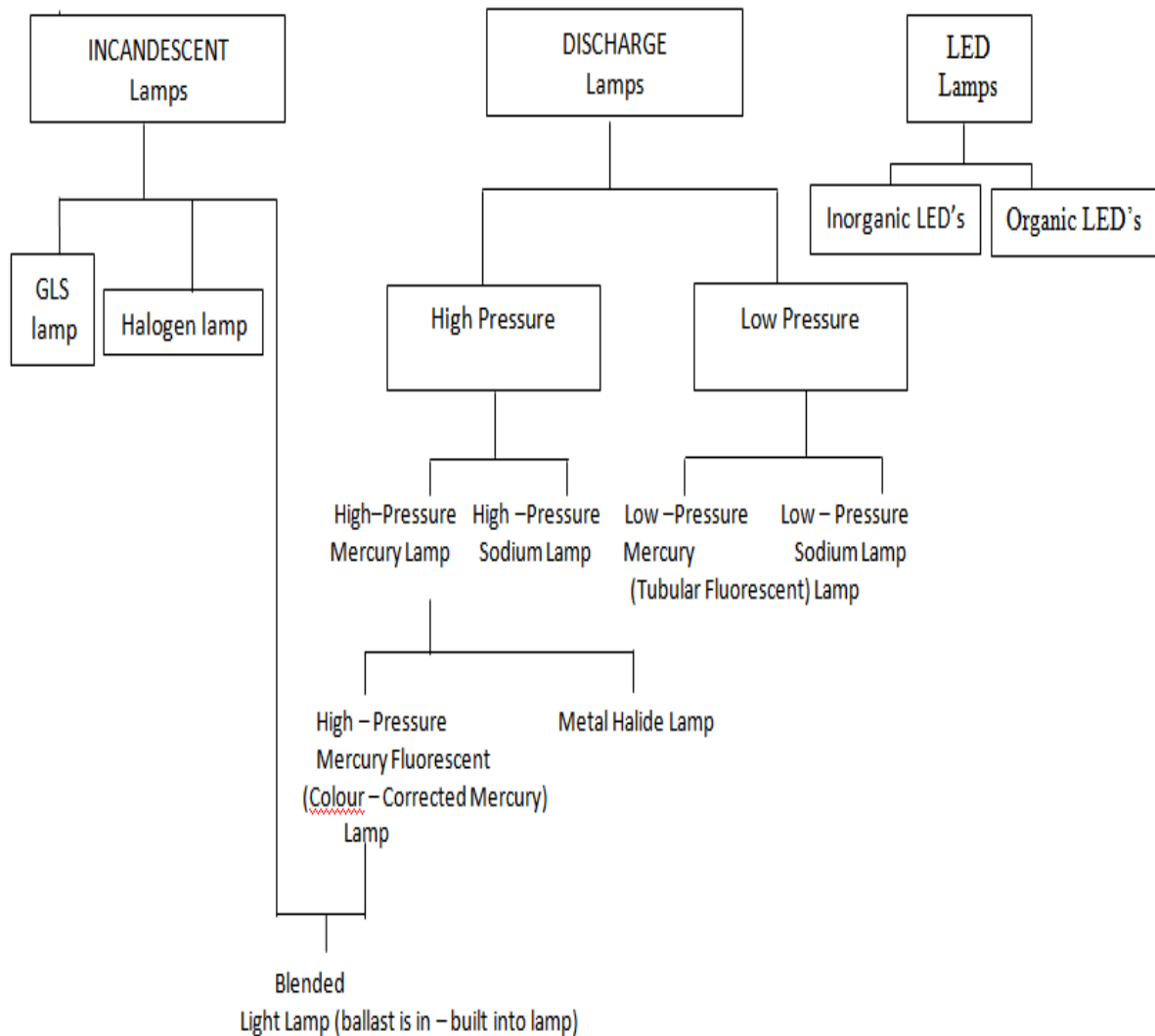

Fig. 2.8 General classification of electric lamps (source: Bommel & Boer, 1980)

2.6.3 Incandescent lamps

Tungsten filament lamp is the most common type used in interior lighting of buildings in surface mine projects. It produces light with a continuous spectrum. These lamps have a

limited life and efficacy. Lamp efficacy varies directly with filament temperatures (Moon et al., 1948). Due to its high operating temperature, the tungsten filament evaporates leading to blackening of the lamp and finally to failure of the lamp. A newer upgrade to the family is

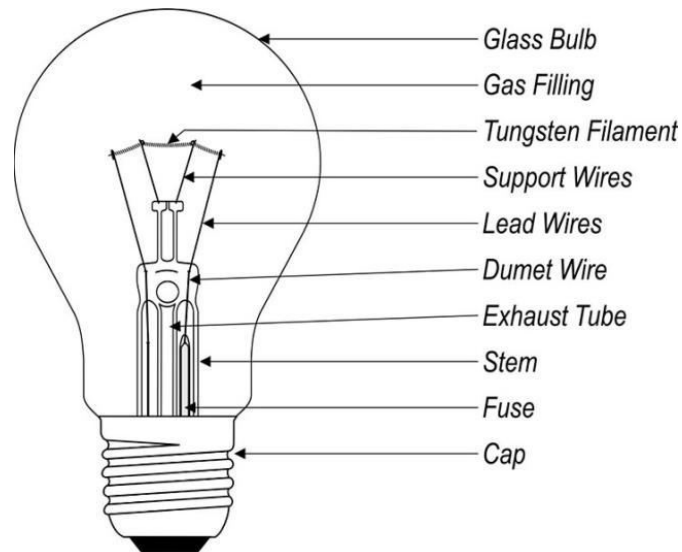

Fig. 2.9 Incandescent bulb (*source*: Lamptech, 2016)

tungsten halogen incandescent lamp is shown in Figure 2.9. In this lamp, a halogen is added as fill gas, thereby preventing blackening of the lamp. This principle makes it necessary to adopt a smaller bulb and to increase the pressure of the inert gas. However the temperature can be higher than with normal incandescent lamps resulting in higher efficacy or longer lamp life. These lamps are extensively used in flood lighting, motorcar lights, traffic signs, projectors and spotlights. Due to their low efficacy and rather limited life, they are not recommended for road lighting purpose.

2.6.4 Fluorescent tube light

The earlier Fluorescent Tube Light (FTL) was of the 'preheat' type, which required the use of a starter. With this type lamp, the cathodes are preheated to emit electrons to aid in the striking of the arc at lower voltage. 'Instant start' lamps were developed next, primarily as an attempt to overcome the slow starting of preheat lamps. This simplifies auxiliary circuit requirements, but the required ballasts are large and expensive (Lewis et

al., 1986). The tubular fluorescent lamp consists of a tubular bulb having an electrode sealed into each end and containing mercury vapour at low pressure with a small amount of inert gas to aid starting as shown in Figure 2.10. The inner surface of the tube is coated with fluorescent powders. When electric current is passed through this gas mixture, predominantly ultraviolet (UV) radiation is produced. The fluorescent powders absorb the UV radiation and radiate in the visible range. By varying the composition of the fluorescent powders, lamp types with

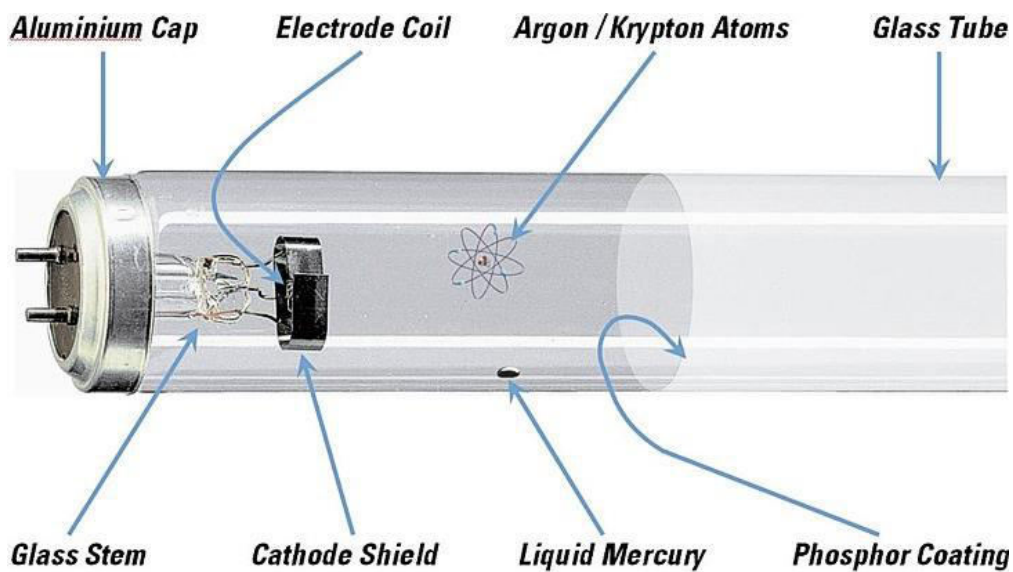

Fig. 2.10 Construction of a linear fluorescent lamp (*source: Lamptech, 2016*)

different colour appearance and colour rendering properties can be made. Fluorescent lamps are commonly available in the range of about 100 lm to 10,000 lm corresponding to 4 W to 110 W. The length of a given lamp is, in general, related to its wattage - higher the wattage, and longer is the tube. These are used where little optical control and low lighting levels are required.

2.6.5 High pressure mercury vapour lamps

High Pressure Mercury Vapour (HPMV) lamp consists of two operating electrodes with an electron-emissive coating, a starting electrode, some liquid mercury, and argon gas (Lewis et al., 1986). The arc tube is where the light is produced. Collisions between electrons and mercury atoms in the arc ionize the mercury atoms to produce the

characteristic spectral lines of mercury. This occurs when the outer electrons of mercury atoms return to their normal state and release radiant energy in the transition. Some energy is in the UV region and is absorbed by the glass envelope. If fluorescent powders are coated on the inside of the envelope, the UV radiation can be converted to visible light. If this is done the lamp is usually called 'colour improved'. Colour improved versions have a lower brightness since the outer envelope is the 'apparent light source'.

Unlike other discharge lamps, however, the high pressure mercury vapour lamp is available in a special version in which the ballast is built into the lamp itself. This so-called blended-light lamp is less efficient in operation than the normal high-pressure mercury lamp as shown in Figure 2.11. This can be connected directly to the mains just like an incandescent lamp (Bommel et al., 1980).

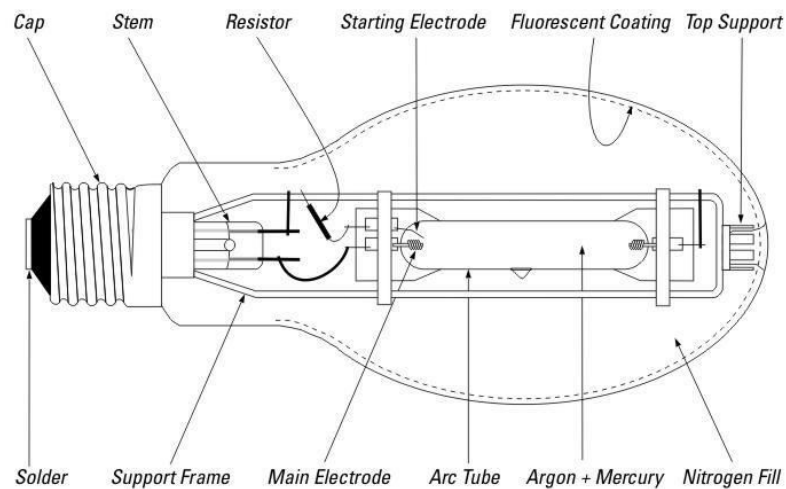

Fig. 2.11 High pressure mercury vapour lamp (*source*: Lamptech, 2016)

2.6.6 Metal halide lamps

Metal Halide (MH) lamps are similar in construction to the HPMV lamps, the major difference being that the discharge tube of the former contains one or more metal halides in addition to mercury as shown in Figure 2.12. A typical combination of halides used is that comprising of the iodides of sodium, indium, and thallium. These halides give an increase in intensity in three spectral bands: blue, green and yellow-red. The radiation

emitted lies in the region of the spectrum to which the eyes are highly sensitive. The result is a lamp with reasonable colour rendering and an efficacy of over 80 lm/W for a 400 W lamp. Its main application lies in the floodlighting for large areas. The life of the metal halide lamps is shorter than that of corresponding wattage of other discharge lamps. So, these lamps do not offer an economical solution for road lighting. Most metal halide lamps are commonly available in the approximate range of 20,000 to 2, 00,000 lm corresponding to 250 to 2000 W.

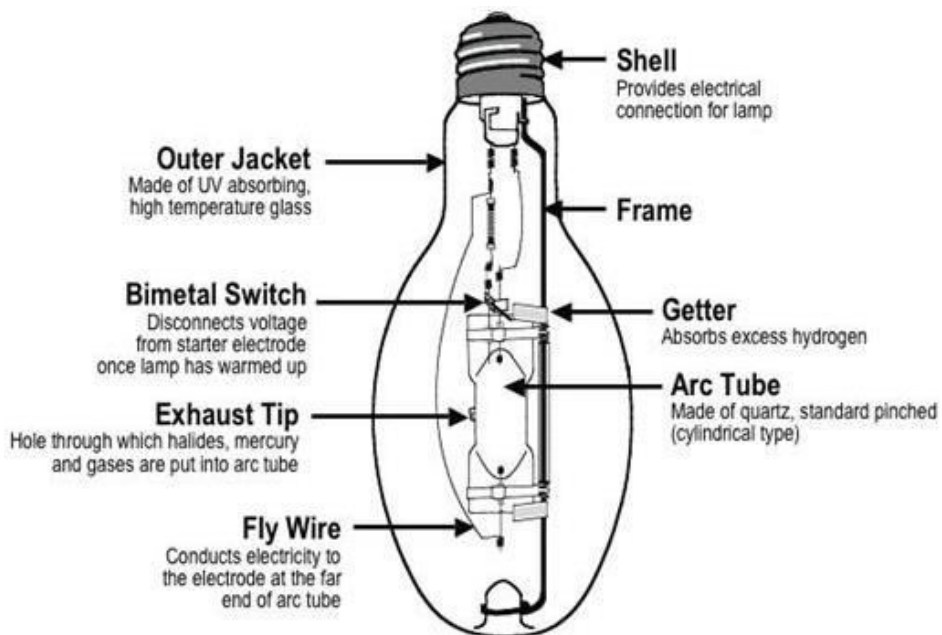

Fig. 2.12 Metal halide lamp (source: Venture Lighting, 2012)

2.6.7 Low pressure sodium vapour lamps

The Low Pressure Sodium Vapour (LPSV) lamp consists of a borate coated sodium resistant U-shaped tube contained inside a cylindrical glass envelope. A small quantity of sodium is operated inside a U-shaped tube at a temperature around 235 °C. A mixture of inert gases like neon, argon, xenon and helium is present to aid in starting. A high vacuum is applied inside the outer glass envelope to prevent convection heat losses from the arc. When first started, the lamp appears red due to the neon discharge, but this gradually gives way to the characteristic yellow as the sodium is vaporized as shown in

Figure 2.13. The lamp may require 15 minutes to reach full brightness and 1 to 2 minutes to restart after a power failure. Low-pressure sodium lamps are available in the approximate range 2,000 to 35,000 lm corresponding to 18 to 180 W. Low pressure sodium vapor lamps have not become popular for mine lighting.

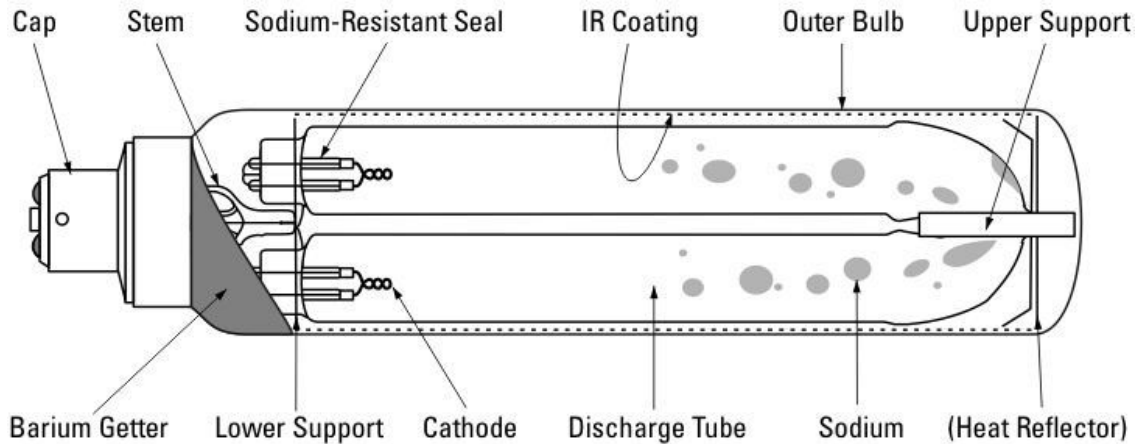

Fig. 2.13 Low pressure sodium vapour lamp (*source: Lamptech, 2016*)

2.6.8 High pressure sodium vapour lamps

The arc tube in High Pressure Sodium Vapour (HPSV) lamp is smaller in diameter than the arc tube of a mercury vapor lamp and is made of a translucent high-transmissivity, polycrystalline-alumina ceramic as shown in Figure 2.14. Contents of the arc tube include two operating electrodes, mercury-sodium amalgam and xenon gas. As the narrow diameter arc tube maintains a high operating temperature, starting electrode is not required for warming up. HPSV lamp has about twice the efficacy of the HPMV lamp. Sodium gives a higher proportion of radiation at wavelengths in the visible range for which the eye has its maximum sensitivity compared to mercury, Hence the higher efficacy of sodium lamp. Sodium gives a higher proportion of radiation at wavelengths in the visible range for which the eye has its maximum sensitivity compared to mercury. The lamp was made possible by the invention of a translucent ceramic arc tube and a process for sealing electrodes in the tube to withstand high temperatures and the corrosive effects of heated sodium vapors. In case of HPSV lamps, a special ballast

circuit is utilized to provide a short duration, high-voltage spike across the main electrodes, which readily ionizes the xenon gas. The xenon gas vaporizes the amalgam that enters the arc stream. Lumen output increases until a steady state operating condition is reached in about 3 minutes. HPSV lamps are available in the range 3,000 to 1, 30,000 lm corresponding to 50 to 1,000 W.

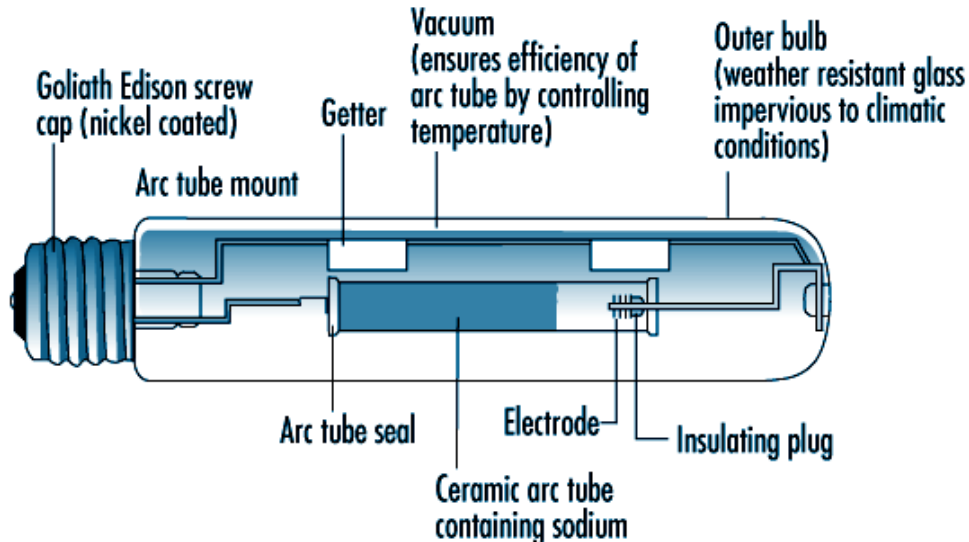

Fig. 2.14 High pressure sodium vapour lamps (*source*: Richard, 2012)

2.6.9 Compact fluorescent lamp

Compact Fluorescent Lamp (CFL) produces light in the same manner as linear fluorescent lamps. The use of tri-phosphors is essential to achieve acceptable lamp life. All compact fluorescent lamps use tri-phosphors, so, when they are used together with linear fluorescent lamps, the latter should also be tri-phosphor to ensure colour consistency. The tube diameter is usually 5/8 inch (T5) or smaller. CFL power ranges from 5 to 100W. CFL's are sold either as "integral" bulb/ballast combinations or "modular" systems as shown in Figure 2.15, which have one or more pin-based bulbs (Richard et al., 2012).

2.6.10 Light emitting diode

Some special diodes emit light when connected in a circuit. They are frequently used as "pilot" lights in electronic appliances to indicate whether the circuit is closed or not. The

two wires extending below the Light Emitting Diode (LED) epoxy enclosure, or the "bulb" indicate how the LED should be connected into a circuit. The negative side of an LED lead is indicated in two ways: (i) by the flat side of the bulb, and (ii) by the shorter of the two wires extending from the LED. The negative lead should be connected to the negative terminal of a battery. LED's operate at relative low voltages between about 1 and 4 volts, and draw currents between about 10 and 40mA. Voltages and currents substantially above these values can melt a LED chip. The most important part of a LED is the semi-conductor chip located in the center of the bulb as shown in Figure 2.16.

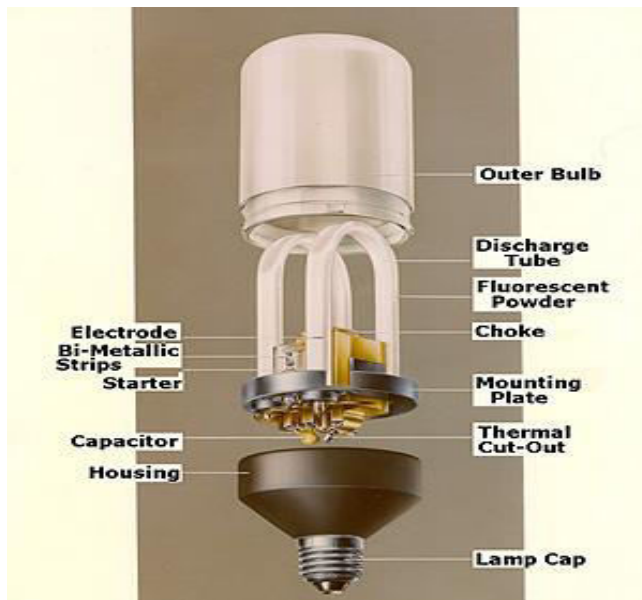

Fig. 2.15 Compact fluorescent lamps. [Source: Colin, 2009]

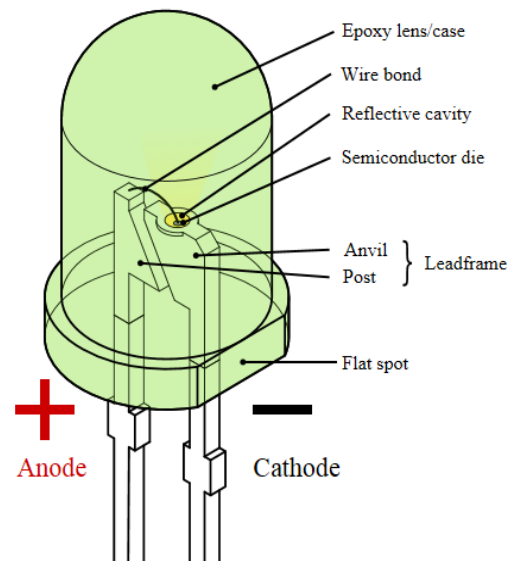

Fig. 2.16 LED source (source: wikipedia.org, 2010)

The chip has two regions separated by a junction. The p region is dominated by positive electric charges, and the n region is dominated by negative electric charges. The junction acts as a barrier to the flow of electrons between the p and the n regions. Only when sufficient voltage is applied to the semi-conductor chip, can the current flow and the electrons cross the junction into the p region. In the absence of a large enough electric potential difference (voltage) across the LED leads, the junction presents an electric

potential barrier to the flow of electrons. The electric energy is proportional to the voltage needed to cause electrons to flow across the p-n junction.

2.6.11 Comparison of various light sources

A tremendous variety of lamps are available in the market with a large option in bulb shapes, socket threads and filament design. The study results imply that the primary factors which contribute to premature lamp failure on mine applications are machine vibration, shock levels, dust deposition and over/under voltage drive (Yingling et al., 1982). So one should select lighting system components based on prevailing mining conditions. Various manufacturers came with different specifications/properties of

Table-2.4: General characteristics of representative lamp types (Canara Lighting, 2012)

Lamp type	Properties for indicated lamp wattage			General lamp properties		
	Lamp wattage (W)	Luminous efficacy (lm/W)	Ballast loss (W)	Color appearance	Approx.luminous flux range (lm)	Life (hrs)
Normal * incandescent	100	15	-	Reddish	100-3500	1000
Halogen * incandescent	1000	20-25	-	White	1000-25000	2000
Tubular fluorescent	40	53	13	Cool white	100-10000	5000
High pressure mercury	400	50	36	Bluish white	2000-125000	5000
Metal halide	400	50-60	36	Day light	20000-200000	10000
High pressure sodium	400	100	40	Golden yellow	5600-130000	15000
Low pressure sodium	100	100	40	yellow	2000-35000	12000

*No ballast required

luminaries. The types of luminaires and their properties have been given in Table 2.4. Table 2.4 also gives the general characteristics of representative lamp types. The Table 2.5 gives the comparison of LED source with other types of conventional sources, where

as the Table 2.6 gives the comparison between different features of CFL, LED and Incandescent sources.

Table-2.5: LED compared with other conventional sources

Light source	Typical luminous efficacy(lumens/watt)	Average Lamp Life(Hours)	Colour Rendering Index
Standard Incandescent	12.5-17.5	750-1000	100
Tungsten-Halogen	16-24	2000-4000	100
Compact Fluorescent	45-75	10,000	80
Tubular Fluorescent	60-100	15,000-24,000	50-90
Mercury Vapor	35-65	Up to 24,000	15-30
Metal Halide	75-100	10,000-20,000	60-90
HPSV	85-150	Up to 24,000	9-70
LED	30-90	Up to 50,000	75

Table -2.6: Comparison between different features of CFL, LED and Incandescent bulbs

Features	Incandescent Bulb	CFL (Compact Fluorescent Lamp)	LED (Light Emitting Diode)
Durability	Not very durable	Not very durable	Very durable
Heat generation during operation	High	Medium	Negligibly low
Fire hazard	Hazardous	Hazardous	Hazardless
Security to low and high temperature as in underground coal mines	Moderate sensitive	High sensitive. It does not work properly at 15°F or over 100°F	Negligibly low sensitive
Carbon dioxide emission (bulb/year)	68	15.8	6.8
Turn-on mechanism	Instantly	Delayed	Instantly
Mercury content	No	Yes	No
Life span in Hrs.	1000	12000	100000

Figure 2.17 illustrates the elevating efficacy of each of the principal light source technologies over time. It is interesting to note from this chart that since the inception of

each light source technology, it generally maintains its relative position in the league of efficacies at all times - rarely overtaking or falling behind a competitive light source. The sole exception to this is the semiconductor light emitting diode, which has only witnessed significant development in very recent times. There is no doubt that this unique light source will overtake many of its competitors in its efficacy. However, it remains to be seen whether or not LED's can be developed in other areas, particularly luminous flux and cost, which would see them begin to threaten other light sources. The prime position which LPSV holds at the top of this chart is expected to be maintained for many years in future.

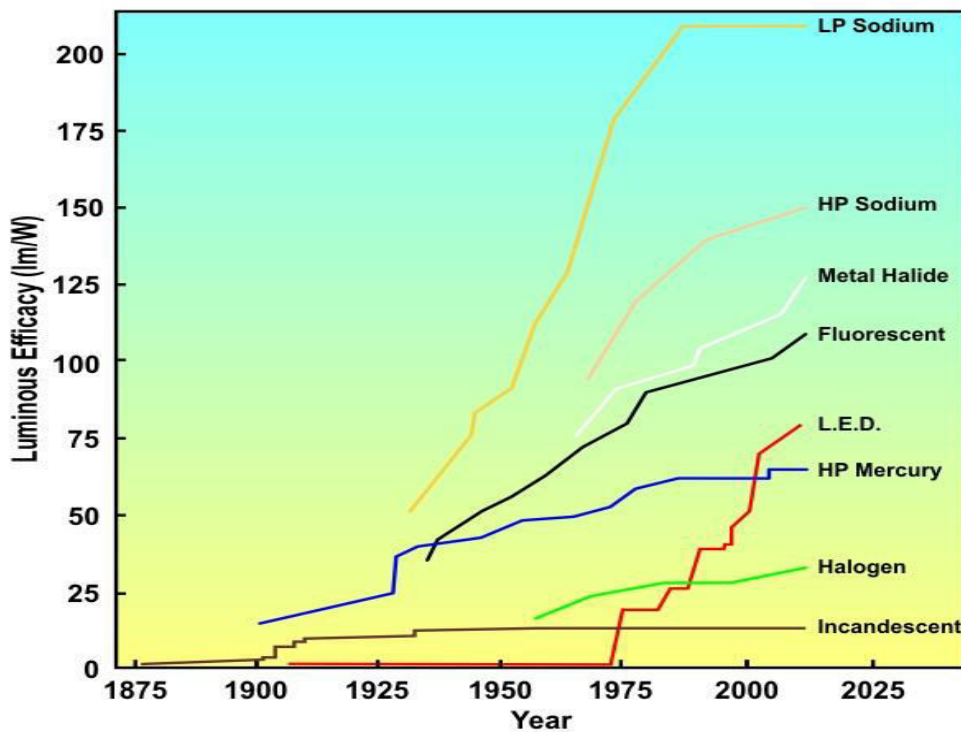

Fig. 2.17 Effects of technological progressions on the efficacy of light sources (source: Lamptech, 2016)

2.7 System of Surface Mine Lighting

The general lighting scheme of an surface mine is usually connected to a common power source. So, to avoid complete darkness in case of power failure, every Heavy Earth Moving Machinery (HEMM) is provided with self mounted lighting system. The modern

heavy-duty face machinery dictate increase in the bench height, forcing individual face lighting system. Individual lights may also be provided at active zones in addition to the general lighting scheme. The luminaries may be mounted on:

- machines used in the mines.
- movable telescopic as well as tiltable trolley mounted lighting mast.
- low height (1.5-2.0 m) tripods for spot face lighting.
- towers erected on planned locations outside the blasting zone.

Generally lamps mounted on tripods are used near the loading machines at the face. The cable wheel may be placed at one end, so that the cable can be stretched along the length of the face. Telescopic lighting mast (also called mobile light towers) either self-powered or towable type is used at the place, where more number of activities is carried out simultaneously. In some critical areas such as dumpyards, stackyards etc., where the dumping activities and vehicle movement are being carried out, it is advisable to go for movable lighting system connected to the main lighting scheme. In many of the mines it is found that the separate portable type generator set is provided for the dumpyard illumination. The high mast system can be provided depending on the dumping surface area. The wide acceptance of the high mast system (also called towers) involves design, supply and installation of luminaries and lamps. The light towers used are generally of 12, 20 or 30m height. Places like stackyards, wagon loading point, crusher site etc. are illuminated by MH or HPSV lamps mounted on towers. Each tower consists of four to six luminaires covering a large area, around it (Anon et al., 2009).

Haul road illumination

The haul roads are illuminated with single side arrangement of poles, which can be shiftable and erected on a pre-planned safe distance. In most of the Indian mines the height of the poles vary from 7 to 12m, with the angle of the light arm usually 10° to 45° , vertically upward with horizontal. The HPSV and FTL lamps are very commonly used for surface mine lighting. In some of the mines HPMV lamps are specially used for roadway lighting. In semi-mechanised mines, where FTL are used, halogen lamps (HAL) are used for illuminating the road junctions.

2.8 Requirements of Good Lighting

2.8.1 General requirements

Since miners are to work hard in contaminated and dusty atmosphere at elevated temperature, exposed to high frequency noise and vibration, dense cloud of fog in case of hilly deposits - an adequate lighting without any irritating glare problems would provide some respite. Improper artificial lighting at dark hours and in fog/smog has been responsible for many accidents (Kejriwal et al., 2004). In general, for any task to perform safely and efficiently, good illumination should be provided so that one can see the task and its surroundings very clearly (Bell et al., 1972; Chironis et al., 1974). The number of errors falls to a minimum with good lighting (Bell et al., 1972; Trotter et al., 1984).

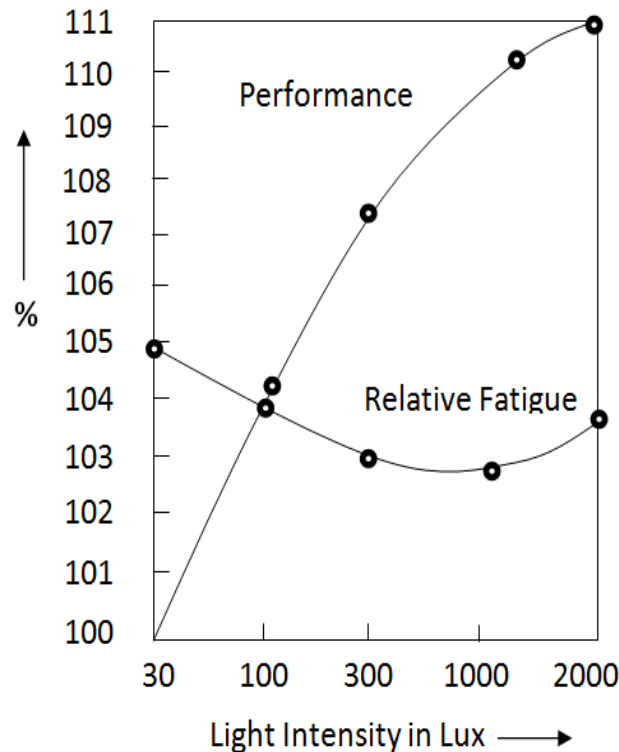

Fig. 2.18 Effects of light intensity on performance and fatigue (*source*: Schaffer, 1961)

Proper selection of light source for particular type of work is very important. Simply providing bigger and brighter lights than the required ones does not necessarily produce

better mine illumination, rather, in all probability, it is likely to affect the performance of workers (Anon et al., 1976). Figure 2.18 shows the effect of light intensity on performance and fatigue. Lighting system should always be designed for older eyes (Walsh et al., 1958; Weale et al., 1961; Anon et al., 1975). Figure.2.19 shows illuminance loss with age of a Person. A good mine illumination system is expected to meet the following three concepts (Skinner et al., 1987):

- i. Worker acceptance: The mine worker must conceive that he is benefiting from the illuminated working area.
- ii. Operator acceptance: The mine operator must realize benefits from the cost of illumination system.
- iii. Compliance: The illumination system should comply with the guidelines specified by the regulatory bodies.

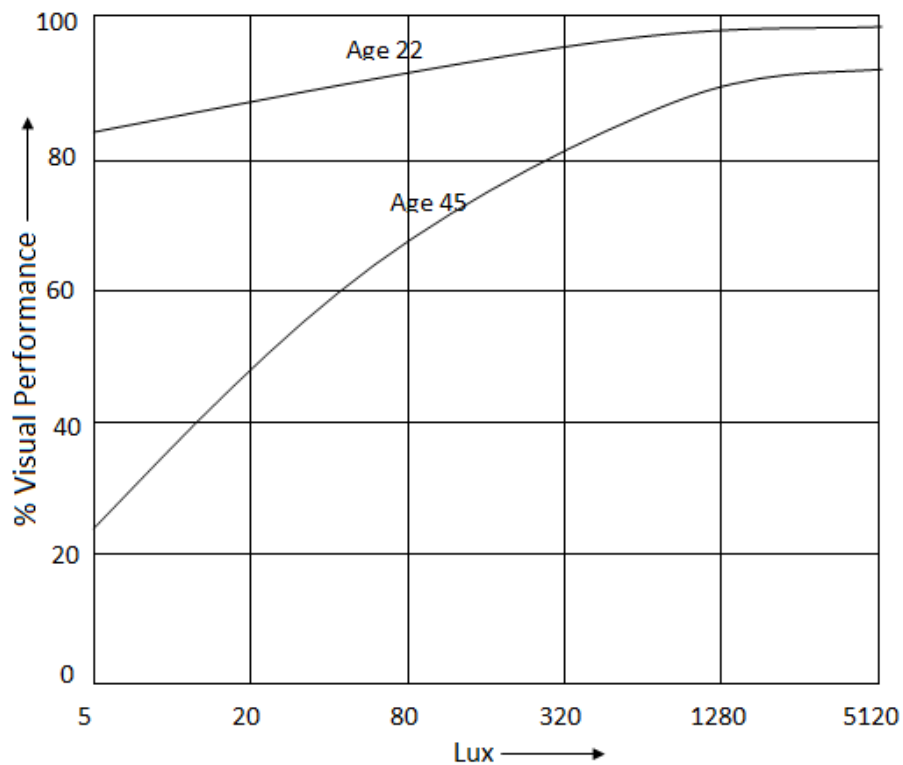

Fig. 2.19 Comparison of visual performance between two different age groups (source: Lyons, 1980)

2.8.2 Technical requirements

An effective lighting installation is one, which has been designed and installed so that individual may work with safety and efficiently, and with reasonable comfort (Roberts et al., 1962). This is influenced by three main lighting design parameters: illuminance level on the surface, uniformity of light distribution and glare from sources. The most important aspect of lighting design is to provide sufficient illuminance on a visual task. For example, when a road is referred to as being 'evenly lit', this means that, when viewed from a haul truck, the road surface appears to be 'evenly bright', i.e. the luminance of the road surface should be as uniform as possible without dark patches (Waldrew et al., 1961; Lyons, 1981). Luminous intensity of light source takes care of illuminance on visual tasks, whereas uniform distribution pattern depends on the technological aspects like luminaire layout, aiming angle and positioning of the light sources (Dutt et al., 1960).

Lighting system should not render irritating glare problems. The aiming angle of the light source, its intensity, surface area of the bulb, type of reflectors etc. play significant role in designing of illumination system, in order to reduce glare in the field of vision. To some extent tip-frosted bulbs avoid glare from the source as this design conceals the filament of the bulb from direct vision (Strachan et al., 1955; Anon et al., 1954). However, glare is not a major problem in surface mine lighting as the lamps are, in general, mounted at considerable height. Moreover, bulb material is selected to provide diffuse transmission causing scattering of lights. These two aspects reduce the burden on the designer as only illuminance level and uniformity ratio are to be taken into consideration for general lighting in surface mines.

2.8.3 Important places to be illuminated

Some of the activities/areas that require sufficient illumination in the surface mine are:

- At the working faces of ore/OB to facilitate digging and loading operations, for positioning buckets during loading and unloading, to illuminate the highwall
- Material to be loaded and filling level in the bucket

- Illumination of haulroad
- Spotting dumpers for loading and unloading at dumpyards, stackyards etc
- Viewing the edge of the dump and general areas
- Inside the cabins of machinery and along walkways
- Below the shovels, under the carriage to identify any leakages and for handling of trailing cables during relocation manoeuvres
- Over the deck of shovels and draglines for routine maintenance and inspection at drill site for different operating manoeuvres
- In case of conveyor haulage system lighting needed for inspection and maintenance
- At crusher site, bunkers, vibrators, wagon loading point etc
- At maintenance shop, general repair workshop, auto electrical shop etc

2.9 Problems in Surface Mine Lighting

2.9.1 Continuous moving face

Mines in general, are not well lighted places. Howell (1937) remarked that the lighting is one of the most difficult problems in mining industry. It was recognized as an area involving unique and special lighting problems in 1931 when the CIE had established a Study Committee-29 (Hottinger et al., 1982). The mine worker must be able to see in order to accomplish his task and more important, to be safe. In mines since almost everything involves movement and the tasks are dynamic, it is very difficult or sometimes may be impracticable to provide any kind of permanent structure for lighting, because of the costs of the installation and its upkeep (Bandhopadhyay et al., 1989). Since mine face is moving continuously, it demands lighting equipment to be mounted on machines as well. Such system must be durable to withstand any kind of physical abuse or hazards encountered during mining operation. Experience has shown that the most effective illumination is obtained by mounting the lighting fittings on the machines (Bell et al., 1964).

2.9.2 Adverse working conditions

Because of adverse conditions in the mines light should come from the right direction, in right quantity and of right colour, ideally without glare. But due to typical working nature in the mines it is very difficult to fulfill these requirements, and also the orientation of the light at work site is a challenging task. Due to this reason machine operator and other workers in a mine need to be able to orient themselves in a difficult visual environment. The haul roads always keep on changing to tune with the mining activity. Other critical area such as dumpyards, stackyards etc. also change their phase with time, and it is difficult to illuminate such areas. For example, at dumpyards lighting should be provided at the drivers' side, which is always not possible, due to changing configuration of dumpyards.

The movement of HEMM generates dust, which causes significant reduction in light emission from the sources. It was estimated that the dust and dirt collected on a lamp or luminaire cover can reduce the light output by as much as 20 % (Bell et al., 1972). In some mines fog is a major problem, due to which the loss in working hours is even up to 120-240 hr/yr. The major effect of fog is to reduce the contrast of colour and brightness of surrounding environment (Homes et al., 1975). Contrast is usually low in a mine, since most of the light is absorbed by surrounding rock (Anon et al., 1984). In hilly deposits, in monsoon, due to rough weather condition breakages of light fixtures, especially fluorescent tube lights are very common. Due to continuous movement of task and undulating terrain it is difficult to maintain the uniform light level in the work site.

CHAPTER 3

DESIGN FEATURES OF ILLUMINATION SYSTEM

In lighting design, the primary goal is to cater a visual environment in which people may efficiently perform specific tasks and receive agreeable visual impressions. The process of design is a comparison of various alternative systems, trading off their benefits for their cost in accomplishing their goals. The Illuminating Engineering Society of North America (IESNA) has recommended some design practices for lighting (Anon et al., 1974, Anon et al., 1993).

Although the eye is able to make use of wide range of light levels, there are certain conditions under which it works best. Good artificial lighting system influences the condition of seeing, which facilitates in reducing worker's fatigue, protecting their health, eyes and nervous system, and reducing accidents. These benefits tend to offset the cost economics of lighting or it may be many times greater than the cost of the lighting (Lyons, 1981). The selection of artificial light installations for a particular job is very important. The design features such as selection of type of lamp, luminaire, reflectors and mirrors, mounting height of lamps and their orientation, luminaire layout etc. are important in the designing of the lighting system for any project. Before providing artificial lighting one should outline the specific requirement of lighting system, rather than by turning off to require lighting conditions, after the installation. So, to ensure effective lighting system necessary information has to be collected, such as

- type of activities/nature of working
- areas requiring illumination in the mines
- requirement for safe performance
- minimum light level required
- reflectance of surrounding surfaces
- existing standards and guidelines.

3.1 Principle of Lighting

Comfortable vision is a highly subjective parameter, which may be difficult to ascertain. It is influenced by various factors, both physical and personal. An effective lighting installation is one, which has been designed and installed so as to provide sufficient illuminance on a visual task. So, while designing illumination system, one must remember that, it is not the machines that need light, but the men who are to operate the machines, and others who must work and move in their vicinity.

3.1.1 Illuminance and luminance level

Illuminance is one of the factors, which influences visibility. Illuminance is governed by lighting standards specified by various regulatory bodies. These standards are for the purposes of guidance only, because depending on other factors, better visibility may be achieved with lower illumination, or even the standards mentioned may give inadequate lighting. In fact illumination affects visibility in an indirect manner. The amount of light reflected from the object to be seen, i.e. its brightness level is of direct importance. An increase in lumen output probably means an increased surface brightness. The brightness of the surface mainly depends upon the incident illumination falling on the surface and also on its reflection factor. In mines, because of poor surrounding reflectance, the actual required light level is very high, compared to the recommended standards. As far as possible, the lighting level should be specified in terms of luminance levels. With increasing luminance the contrast sensitivity of the eye increases and visual performance improves provided glare can be controlled, as discussed later.

3.1.2 Uniformity

Good lighting is not only a matter of more light but is also a matter of proper distribution of light. For example, well-lit road surfaces have to appear evenly illuminated, with no apparent dark patches and a minimum of glare. It is possible only when the distribution of light is more or less uniform throughout the length of haul road. Uniformity ratio of illuminance on a given plane is a measure of the variation of illuminance over it (CIE, 1976). There are two ways of expressing uniformity ratio, (i) ratio of the minimum to

maximum illuminance or (ii) ratio of the minimum to the average illuminance. The latter is known as overall uniformity ratio and denoted as U_o . Overall uniformity ratio is considered for mine lighting design. In mines, because of undulating terrain and continuous movement of working faces, it is very difficult to maintain uniform distribution of light throughout the field. To ensure a certain minimum illuminance for the visual performance at all locations on the visual task, the difference between the average and minimum illuminance level should not be too great. This can be ensured by specifying a minimum value for the U_o . It is recommended (CIE, 1988) that uniformity should not be less than 0.3 for the perception to remain acceptable (BIS, 1991). Bell introduced the concept of diversity ratio which is reciprocal of uniformity ratio (Bell et al., 1972). He suggested the ratio of maximum to minimum illuminance as 5:1 for any lighting installation. The renowned British Lighting Engineer, W. R. Stevens, mentioned that a diversity ratio of 1.5 to 1 in illumination should generally be accepted as permissible minimum level (Anon et al., 2004). The Australian Standard AS 1680-1 requires that the ratio of the minimum to average illuminance on an unobstructed work place should not be less than 0.8 (Anon et al., 2004).

3.1.3 Glare

Glare is caused as a result of any excessively bright source of light in the field of view that results in the loss of visibility, discomfort, annoyance, interference with vision, or eye fatigue (Ronald et al., 1991). Trotter and Louis (1980) justified that glare is not only due to bright light, it also depends upon other factors, both physical and technical. Glare may be of two types, namely disability glare and discomfort glare (Lewis et al., 1986). Disability glare is caused by the action of stray light, which enters the eye and scatters within. It causes a 'veiling illuminance' over the retina, which in turn has the effect of reducing the perceived contrast of the objects being viewed. Discomfort glare is a sensation of annoyance or in extreme cases causes 'pain by high or non-uniform distribution of brightness in the field of view. It does not affect all individuals to the same extent (Beckett et al., 1982; Crouch et al., 1982). Disability glare directly interferes with visibility and ultimately with visual performance. Disability glare is very important in

mining.

Glare problems in the mine may include those resulting from:

- improper focusing of face lights
- focusing of headlights of down coming vehicles
- extreme glare from the machine canopies
- flashing of lights during swinging action of loading machinery
- glare from lights on the sides of machines
- glare from deck floor lights

Unlike underground mines, glare is not a major problem in surface mines. A study of glare reduction for light fixtures used in mining was initiated by Donald Trotter in his work granted by National Sciences and Engineering Research Council (Trotter et al., 1980). Mine lighting glare can probably be best limited by fixture and their placement. Glare from the source can be controlled by using frosted bulbs or with certain diffusion material, which makes the light source to scatter larger and hence less bright (Pandey et al., 1990). Small brightly-lit areas reduce the workers' effective vision, thus increasing the danger from glare. To avoid or reduce glare, illuminance should be fairly of even intensity throughout the visual field. The general level of illuminance should not change rapidly, but should allow time for adaptation to occur.

In the case of area lighting glare is controlled by mounting luminaires on towers, with proper orientation, outside the normal field of view of the observer. In haul road lighting the pole height should be kept maximum, as far as possible, with minimum tilt of light arm. As far as possible light arm should be kept flat to avoid irritating glare problems from the source, which also facilitates uniform distribution of light (Pandey et al., 1990).

HID lamps, especially HPSV lamps are very commonly used in the mines, since they are free from glare and also because of higher efficacy and long life. Because of glowing tungsten filaments incandescent lamps are more likely to cause glare compared to other types of lamps. The advantage of fluorescent lamps is reduced glare. Cotton (1960) made some studies on different types of sources and has shown that mercury source is more

glaring than a sodium at high luminance, but as the luminance decreased, sodium found more glaring.

Lighting level and uniformity are of prime photometric importance in the final selection of a lighting concept (Senguptha et al., 1990). In terms of mechanical design, the most important considerations are those of luminaire size, output, external surface, temperature, power consumption and the need for ballasts.

3.2 Haul Road Lighting

When a road is referred to as being 'evenly lit', it means that, when viewed from haul truck, the road surface appears to be 'evenly bright'. This is achieved by arranging the poles along the length of the road in such a way that the bright patches merge to cover the road area, so that objects on the road will be seen as dark silhouettes against the bright surface. This is the principle upon which road lighting is based, since it proves more economic to produce silhouette than it would be to make objects light and the road surface dark as shown in Figure 3.1 there are four different types of layouts of poles are possible according to the pattern in which poles are sited (Bommel et al., 1980; Lyons, 1981; CIE, 1999).

Among these, single sided pole arrangements is the most prevalent one in mines as installation of poles and electrification process in this layout is simple. But with this type of arrangement the illuminance of the road surface at the side farthest from the luminaire is usually much lower than that of the side nearest to them. This lowers the overall uniformity ratio of illuminance. So, to ensure the overall uniformity ratio, luminaires are mounted at sufficient heights approximately equal to or greater than the effective width of the road (Bommel et al., 1980). The effective width is the horizontal distance between luminaire and far kerb.

In conventional road lighting installation the luminaires are oriented in such a way that their beam axes are pointing along or near the road axis and where the spacing between adjacent luminaires is more or less constant. The geometric variables in such an

installation are the mounting height of luminaire, spacing between the adjacent poles, overhang and inclination or tilt angle of luminaire.

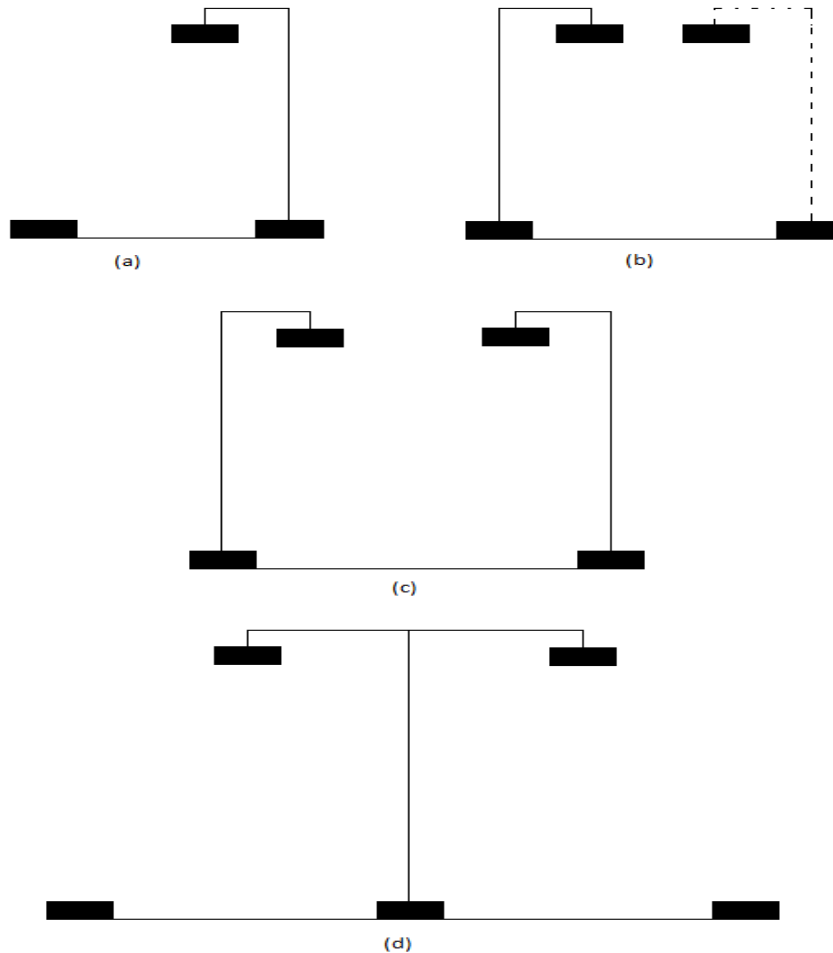

Fig. 3.1 The four basic conventional road lighting arrangements
(a) Single sided (b) Staggered (c) Opposite (d) Twin central

3.2.1 Mounting height

Luminaire mounting height depends on the lighting arrangement and effective road width. To achieve good distribution of light across the roadway, mounting height, in general, is kept equal to the road width or around it. Mounting height depends on the characteristics of the source. In general, high power lamps are mounted at greater height than the low power ones.

3.2.2 Spacing

Poles spacing for a given lighting arrangement and luminaire light distribution is dependent on the mounting height and the longitudinal uniformity aimed for the installation as shown in Figure 3.2. The greater the mounting height, the larger can be the spacing for a given longitudinal uniformity (Bommel et al., 1980; Glanville et al., 1960). However, in practice, excellent illumination is considered to be the one when pole spacing is not more than 8 times the mounting height (Bommel et al., 1980).

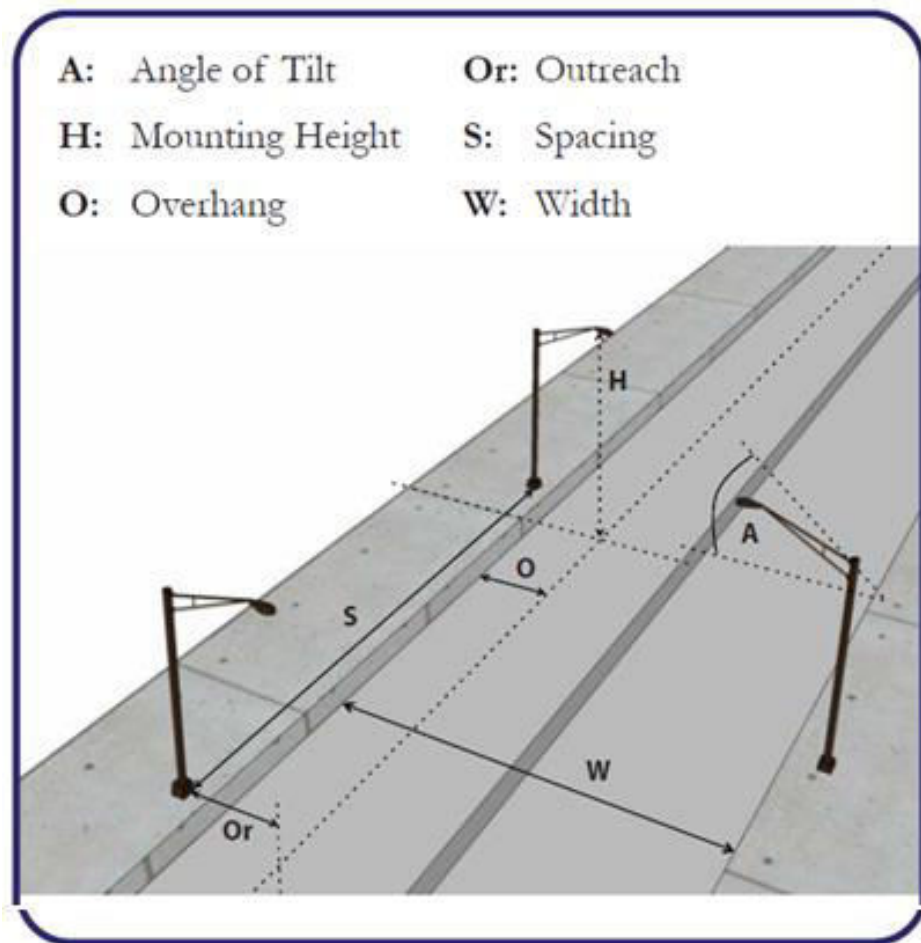

Fig. 3.2 Street lighting features (source: BIS, 1981)

3.2.3 Overhang

Poles are generally installed somewhat off-set from the road edge (kerb) to provide clearance to the vehicle. Luminaire is mounted on the ranging arm to adjust the distance

between it and the kerb. Sometimes, projection of the luminaire lies inside the road from the kerb, which is known as overhang. The main purpose of overhang is to provide better uniformity of light across the road. In effect, the amount of luminaire overhang reduces the effective width of illumination of the road. The effective road width is equal to width of the road minus luminaire overhang (Bommel et al., 1980). The overhang, if necessary, can be adjusted in such a way that, particularly in the interest of providing good visual guidance, the luminaires appear to form a smooth line in the driver's field of view.

3.2.4 Tilt angle

Inclining or tilting the luminaires up from the horizontal is done to increase light coverage across the road width at a given mounting height. But this measure is not very effective. If the effective road width is large compared to the mounting height, tilting the luminaires will facilitate improving light level at the far side of the road. But high tilting will diffuse the light and reduce its distribution along the longitudinal direction of the road. It is recommended that the angle of tilt, with respect to the normal height of mounting, be limited to an absolute maximum of 14° , a top limit of 5° , being preferable (Bommel et al., 1980). In general the angle varies from 10° to 20° . High tilting, especially at bends in the road, also increases the chances of glare.

3.3 Area lighting

In area lighting floodlighting is used wherever possible. The principal difference in use between floodlights and other luminaire types employed in outdoor lighting is that the former are not aimed in standard directions with regard to the areas being lighted. Instead, they are individually aimed at pre-calculated spots. With this, lighting designer needs to know how the light from floodlight will spread over the area. He needs to know exactly in what direction the luminous flux radiated from the floodlight will be at a maximum. In places where work area is limited, such as loading and unloading points and crushing site etc. high wattage mast- luminaires can provide good general illumination. In large areas such as dump yards, stack yards etc. lighting can be provided by portable light towers. These light towers are telescopic and tiltable type, so as to ensure consistent

illumination output and uniform distribution of light. Working faces may be illuminated by the sources coupled with face lights installed either at the same face or on the top face, directed towards the loading site. Since both horizontal and vertical illuminances are to be provided at face, one should design the system for both direct and indirect light.

3.4 Economics of Lighting

Various studies have shown that improved road lighting can help to reduce the number of night time accidents (Bell et al., 1972; Chironis et al., 1974; CIE, 1976). But any improvement in the lighting quality is an economic decision and good efficient road lighting can prove to be economically feasible. In any lighting system cost of energy consumption is a major running cost component; however one cannot say that energy efficient lighting system is always the cost effective one. Many factors play vital roles in determining the costs and energy effectiveness of a road lighting installation. Among these, lamp efficacy, lamp life and its benefits affect the whole economics of the installation. Other factors, such as lamp price, number of particular type of luminaires, pole type and arrangement, type of control gear employed, the location of the electricity supply cables, depreciation cost, rate of interest and cost of labor and maintenance are also significant. The relative importance given to each of the above factors will be dependent upon the local circumstances prevailing. There are, therefore, no general applicable rules for minimizing on costs and energy. Figure 3.3 shows the geometry and terminology used in a typical road lighting installation.

When considering the quality of a particular type of lamp, it is always preferred to go for those lamps which consume the least possible electricity to give the required quantity of light. In other words, the most efficient lamps are cheapest in the long run. Using lamps having a high luminous efficacy and suitable light distribution can reduce the overall costs of a lighting installation. Sources with a longer life are always desirable, since it reduces the replacement cost (Mehtha et al., 2003). Lamp selection is made mainly based on efficacy and suitability to each situation. Because of long life and efficient penetration character in dusty and foggy environment, HPSV lamps offer high performance in surface mine lighting. The color and monochromatic character do not matter much in

roadway and area lighting installation. The lower power consumption for a given amount of light, which in spite of the higher cost of the lamps, makes the overall cost of an installation less with discharge lamp rather than with employing filament lamp.

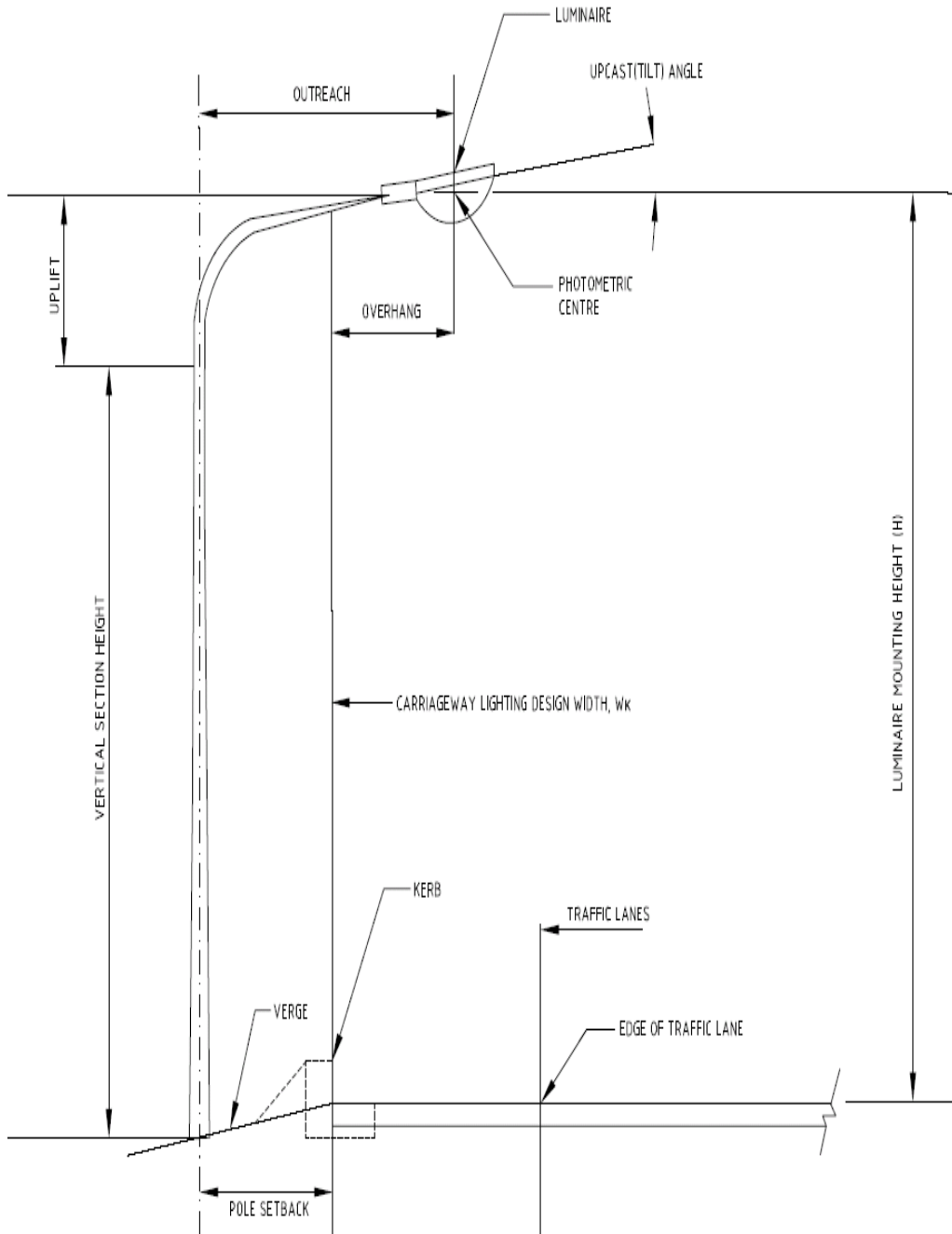

Fig. 3.3 Geometry and terminology used in a typical road lighting installation
(source: SIMRAC 1997)

CHAPTER – 4

COMPUTER AIDED DESIGN OF LIGHTING SYSTEM

During the actual design phase of a lighting project, a lighting engineer has to perform calculations in order to arrive at solutions that will fulfill the relevant lighting requirements. The most frequently calculated quantity in lighting analysis is the illuminance level. Illuminance calculations made using photometric luminaire data presented in a graphical form are rather tedious and time consuming. Graphical methods entail only a limited number of calculations. Such methods should therefore be seen more as a way of performing a limited number of spot checks on a tentative design proposal rather than as an aid in the design process itself. A computer program can perform the calculations more rapidly.

4.1 Design Methodology

While calculating illuminance, one may wish to know the illuminance at a specific point or may be interested in the average uniform horizontal illuminance across the work plane. Based on this principle, there are two methods of design techniques: lumen method and point-by-point method. The lumen method applies only to regular arrays of luminaires (Durrant et al., 1977; Ronald et al., 1991). For other arrangements it is necessary to calculate the effect of individual luminaires at particular points to get the net illuminance. In these situations the point-by-point approach is adopted.

4.1.1 Lumen Method

In lumen or flux method the calculation is based on the average illuminance value required on the working plane (Wadhwan et al., 1990). This method is used to calculate the number of luminaires required for a uniform or general lighting layout. The term 'uniform' means not more than 20 % variation in illuminance, and the symmetrical lighting layout meets the spacing criterion.

The formula used in lumen method is:

Average illuminance = $\frac{\text{flux received on the working plane}}{\text{total area of working plan}}$

or

$$E = \frac{F \times N \times U}{A \times M} \quad (4.1)$$

where, E – Illuminance, lux

F - Lamp flux, lumen

N - Number of lighting points

U - utilization factor

M - inverse maintenance factor, and

A - area of working plane, m²

4.1.2 Point-by-point method

This is a laborious method which is used in special cases, for example, where asymmetric fittings are employed (Anon et al., 1948). In this method illumination received at a point 'P' from each fitting must be worked out separately, for which the candle-powers in appropriate directions are obtained from photometric data of the fittings. The inverse square law and cosine law of illumination are basic to almost every method of illumination design. The point-by-point method is based on these two basic laws, which determine the direct component of illuminance at any given point. To apply the inverse square law in a point-by-point calculation, the distance from the source of light to the point of calculation must be at least five times the maximum dimension of the source. The point-by-point method is best used to determine whether guidelines or regulations governing minimum illuminance and uniformity are being met.

4.2 Formulation of Illumination Design Model

As already stated, the two fundamental laws in lighting design are the inverse square law and the cosine law. Figure 4.1 shows a source 's' mounted at a height 'h' exactly above the kerb of the road, whereas 'P' is the point at which illuminance is to be measured. In the figure 'γ' is the inclined angle between the vertical and the line joining the source to the point P, and 'r' is the inclined distance from the source 's' to the point of

measurement of lux level i.e. point 'P'. The grid dimension is given by a and b, where 'a' is the transverse distance along width of the road and 'b' is the longitudinal distance along the length of the road. The horizontal angle with respect to kerb line is given by 'c'. In Figure 4.1 considering a source at a height of 'h' meters, illuminance at a point vertically below the source is given by the inverse square law (Trotter et al., 1982; Guptha, 2012). According to this law, the total flux received by the task, say at point P, is given by the equation (4.2).

$$E = \frac{I}{h^2} \quad (4.2)$$

where,

E= illuminance at the point of measurement, lux

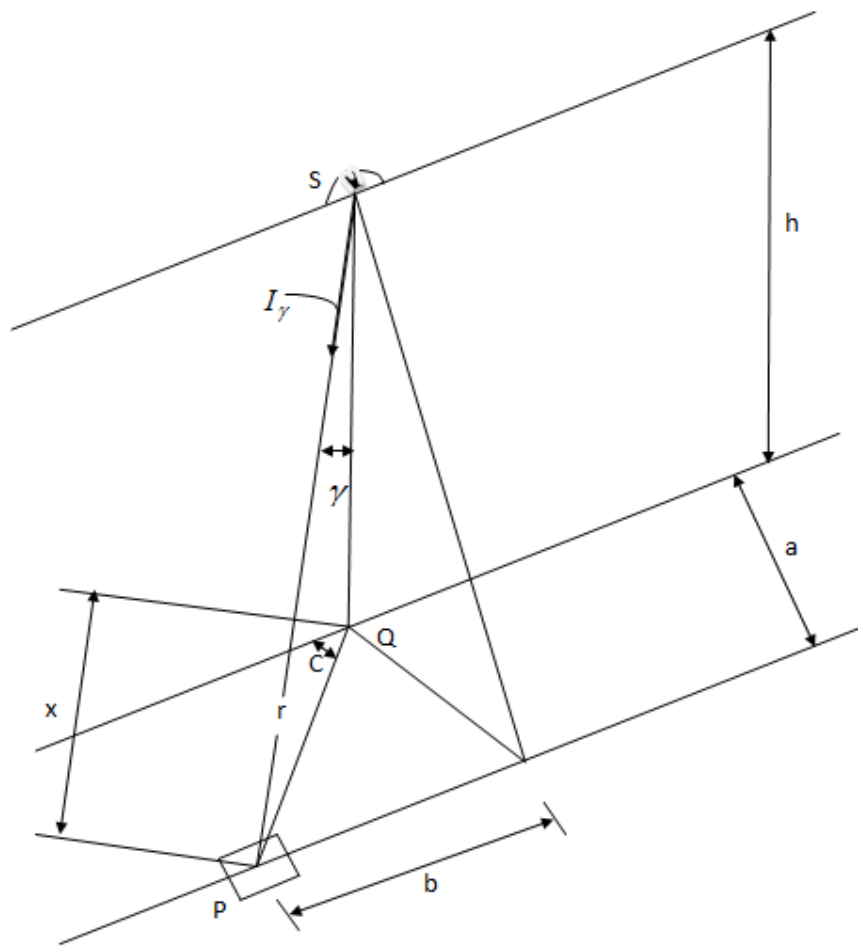

Fig. 4.1 Illuminance on a horizontal plane (source: Trotter, 1982)

base with the kerb line of the road, degree.

γ = vertical angle between the vertical and the line joining the source to the point of measurement, degree and

r = inclined distance (in meters) from the source to the point of measurement, m.

From Figure 4.1

$I_{(C, \gamma)}$ = intensity of light from the source to the point of measurement, candela.

$$\cos \gamma = \frac{h}{r} \quad (4.3a)$$

$$r = \sqrt{a^2 + b^2 + h^2}, \text{ and} \quad (4.3b)$$

$$C = \tan^{-1} \left(\frac{a}{b} \right) \quad (4.3c)$$

where,

a = distance from the source to the point of measurement along γ - plane, m and

b = distance from the source to the point of measurement along C- plane, m.

After installation of the luminaire, practically available illuminance level at P will depend on two more factors 'utilization factor' and 'maintenance factor'. Utilization factor(UF) is expressed as the ratio of utilized flux to the luminous flux emitted by the luminaire. This factor takes care of the absorption of light by dust, lumen depreciation from lamp aging, absorption of light in the fitting, ballast efficiency, drop in line voltage etc (Anon et al., 1948; Anon et al., 1983). Factors influencing the rate of depreciation are illustrated in IS-3646 (Part-1) (BIS, 1966). Though utilization factor can vary to a great extent, under normal conditions of the mine, it usually lies in the range of 0.6 - 0.8. Performance of luminaire depends on the level of its maintenance in terms of cleaning. Maintenance factor (MF) depends on several parameters, like atmospheric condition, type of fixtures and how well the lamps are maintained (Uppal, 2013). The suitable maintenance factor based on the above conditions is described in IES Technical Report No. 9. Improper maintenance may reduce the light level even by 50 to 70 % (Black et al., 1956; Hottinger et al., 1982; Trotter et al., 1982). Impact of maintenance is incorporated in the equation

as inverse maintenance factor (IMF) whose value ranges between 1.2 - 1.3 under normal condition of the mine (Henderson et al., 1972).

By considering utilization factor and inverse maintenance factor the equation (4.3) can re-written as:

$$E_h = \frac{I(c, \gamma) \times UF}{r^2 \times IMF} \times \cos \gamma \quad (4.4)$$

The above equation is valid only when the luminaire is installed such that its axis strikes the illuminating surface vertically. In other words, the equation is valid with zero tilt of the ranging arm only.

4.2.1 Formulation of generalized illumination design model

To overcome the limitations of equation (4.4) as mentioned in the earlier section, a generalized equation was derived incorporating the effect of tilt angle. When the luminaire is mounted on a ranging arm with a tilt angle, say ' α ', its axis strikes the illuminating surface obliquely due to which the cosine law is not applicable. In order to apply the cosine law, the illuminating plane is imaginarily tilted by an angle equal to the tilt angle so that the axis of the luminaire becomes perpendicular to the illuminating surface. The tilted surface would strike the pole line at a different point, thus making the height of the pole increased. Likewise, all other parameters i.e. inclined distance from the source to the point of measurement and distance along γ -plane would also vary accordingly. However there is no change in the distance along C-plane due to the imaginary tilting of the illuminating surface. To incorporate these changes the equation (4.4) has been modified in the following way:

When the source is directly above the kerb side of the road, equation (4.4) can be re-written as:

$$E_h = \frac{I(c_1, \gamma_1) \times UF}{r_1^2 \times IMF} \times \cos \gamma_1 \quad (4.5)$$

where,

$$r_1 = \sqrt{(a_1)^2 + (b)^2 + (h_1)^2} \quad (4.5a)$$

$$a_1 = (a - h \times \tan \alpha) \cos \alpha \quad (4.5b)$$

$$h_1 = h \times \sec \alpha + (a - h \times \tan \alpha) \sin \alpha \quad (4.5c)$$

$$\gamma_1 = \cos^{-1} \left(\frac{h_1}{r_1} \right)$$

(4.5d)

$$c_1 = \tan^{-1} \left(\frac{a_1}{b} \right) \quad (4.5e)$$

When the source is 't₁' m beyond the kerb side of the road, equation (4.4) can be re-written as:

$$E_h = \frac{I(c_2, \gamma_2) \times UF}{r_2^2 \times IMF} \times \cos \gamma_2 \quad (4.6)$$

Where,

$$r_2 = \sqrt{(a_2)^2 + (b)^2 + (h_2)^2} \quad (4.6a)$$

$$a_2 = (a_2 + t_1 - h \times \tan \alpha) \cos \alpha \quad (4.6b)$$

$$h_2 = h \times \sec \alpha + (a + t_1 - h \times \tan \alpha) \sin \alpha \quad (4.6c)$$

$$\gamma_2 = \cos^{-1} \left(\frac{h_2}{r_2} \right), \text{ and} \quad (4.6d)$$

$$C_2 = \tan^{-1} \left(\frac{a_2}{b} \right) \quad (4.6e)$$

When the source is at overhang of 't₀' m, equation (4.4) can be re-written as:

$$E_h = \frac{I(c_3, \gamma_3) \times UF}{r_3^2 \times IMF} \times \cos \gamma_3 \quad (4.7)$$

$$r_3 = \sqrt{(a_3)^2 + (b)^2 + (h_3)^2} \quad (4.7a)$$

$$a_3 = (a - t_0 - h \times \tan \alpha) \cos \alpha \quad (4.7b)$$

$$h_3 = h \times \sec \alpha + (a - t_0 - h \times \tan \alpha) \sin \alpha \quad (4.7c)$$

$$\gamma_3 = \cos^{-1} \left(\frac{h_3}{r_3} \right) \text{ and} \quad (4.7d)$$

$$c_3 = \tan^{-1} \left(\frac{a_3}{b} \right) \quad (4.7e)$$

From equations(4.5) (4.6) and (4.7), a generalized equation to compute illuminance levels at a point P can be written as:

$$E_h = \frac{I(c_m, \gamma_m) \times UF}{r_m^2 \times IMF} \times \cos \gamma_m \quad (4.8)$$

where,

r_m = modified inclined distance between the source and the point of measurement, (in m). which is given by :

$$r_m = \sqrt{(a_m)^2 + (b)^2 + (h_m)^2} \quad (4.8a)$$

a_m = modified inclined distance (in meters) between the source and the point of measurement , (in m) which is given by :

$$a_m = (a \pm t - h \times \tan \alpha) \cos \alpha \quad (4.8b)$$

where t is positive when the lamp is beyond kerb side of the road and it is negative for the lamp with overhang.

h_m = modified vertical height of the source from the point of measurement, (in m). which is given by:

$$h_m = h \times \sec \alpha + (a \pm t - h \times \tan \alpha) \sin \alpha \quad (4.8c)$$

$r_m =$ Modified incident angle of light ray with the vertical, (in degrees).

which is given by:

$$\gamma_m = \cos^{-1} \left(\frac{h_m}{r_m} \right), \text{ and} \quad (4.8d)$$

$C_m =$ modified horizontal angle between the vertical plane along the kerb and the line joining the bottom of the pole to the point of measurement, (in degrees). which is given by

$$c_m = \tan^{-1} \left(\frac{a_m}{b} \right) \quad (4.8e)$$

The combined effect of multiple sources (if more than one source) at point P, is given by equation

$$E_h = \sum \frac{I(c_m, \gamma_m) \times UF}{r_m^2 \times IMF} \times \cos \gamma_m \quad (4.9)$$

Overall Uniformity ratio, is U_0 is given by the equation (4.10):

$$U_0 = \frac{E_{\min}}{E_{\text{avg}}} \quad (4.10)$$

where,

$U_0 =$ overall uniformity ratio

$E_{\min} =$ minimum illuminance level, and

$E_{\text{avg}} =$ maximum illuminance level

Using equation (4.9) and luminous intensity distribution of a luminaire (i.e. $I_{(C,\gamma)}$ table), supplied by the manufacturer, point-by-point calculations of illuminance levels at any point on a horizontal plane can be made. $I_{(C,\gamma)}$ value for a particular luminaire is supplied by the manufacturer either in C- γ table or in the form of isolux contour. C- γ table is commonly used as mentioned in Section 2.4.2 and is used in this design model. C- γ table for ten lamps (100W CFL, 2x40W FTL, 80, 125, 150 and 250W HPMV, 70, 150 and 250W MH, 70, 100, 150, 250 and 400W HPSV, 24, 42, 72, 90, 120, 150, 250 and 300W LED) supplied by the manufacturers is incorporated in this computer program. A typical C- γ table for 70W HPSV source is given in Annexure –I.

4.3 MATLAB Aided Design for Lighting System

Using the above equations (i.e. from 4.2 to 4.10) a computer program has been developed in MATLAB program. Figure 4.3 shows the flowchart for the computer program developed for lighting design. This computer program is capable of calculating intensity of light (lux level) falling on any grid point from one or more numbers of point sources present in that area. This computer program is capable of taking all the design input parameters like – type of sources, mounting height, area of illumination, tilt angle of the source and position of the source.

4.4 Validation of Developed Computer Program

For the validation of the computer program a portable light pole of height 16 m was fabricated, which is shown in Figure 4.4. The arrangements were made in the pole to vary the mounting height of the luminaire from 8m to 16m and to vary the angle of the light arm from 0° to 90° . This was done with the help of handle, pulley and winches, which can be operated easily from the ground. A 150 W HPSV lamp was mounted on a pole at 8m height with 14° tilt angle. The pole is 2m behind the curb of the road and the source is fitted to an arm of length 2m so that the source is above the kerb of the road. The illuminated surface area of the road was divided in to grids of size 1m x 1m. The grids were extended for 9m along the length of the road and 8m along its width. Using digital lux meter, horizontal and vertical lux levels were measured precisely at each grid point as explained in Section 2.4.1. Figure 4.5 indicate the horizontal and vertical measured lux levels in the field.

4.4.1 Measurement of horizontal and vertical lux levels for single 150 W HPSV lamp

The same set of design parameters were taken as input for the developed computer program and was executed to get the output i.e horizontal lux and vertical lux levels, which are shown in the Figures 4.6 and 4.7. The results of the program which are given in Figures 4.6 and 4.7 are closely matching with the measured lux values, which are given in Figure 4.5. The average error was calculated as shown in Table 12 of Annexure -V (for both horizontal and vertical lux readings). The parameters like minimum illuminance (E_{\min}), maximum illuminance (E_{\max}), average illuminance, overall uniformity ratio (U_0)

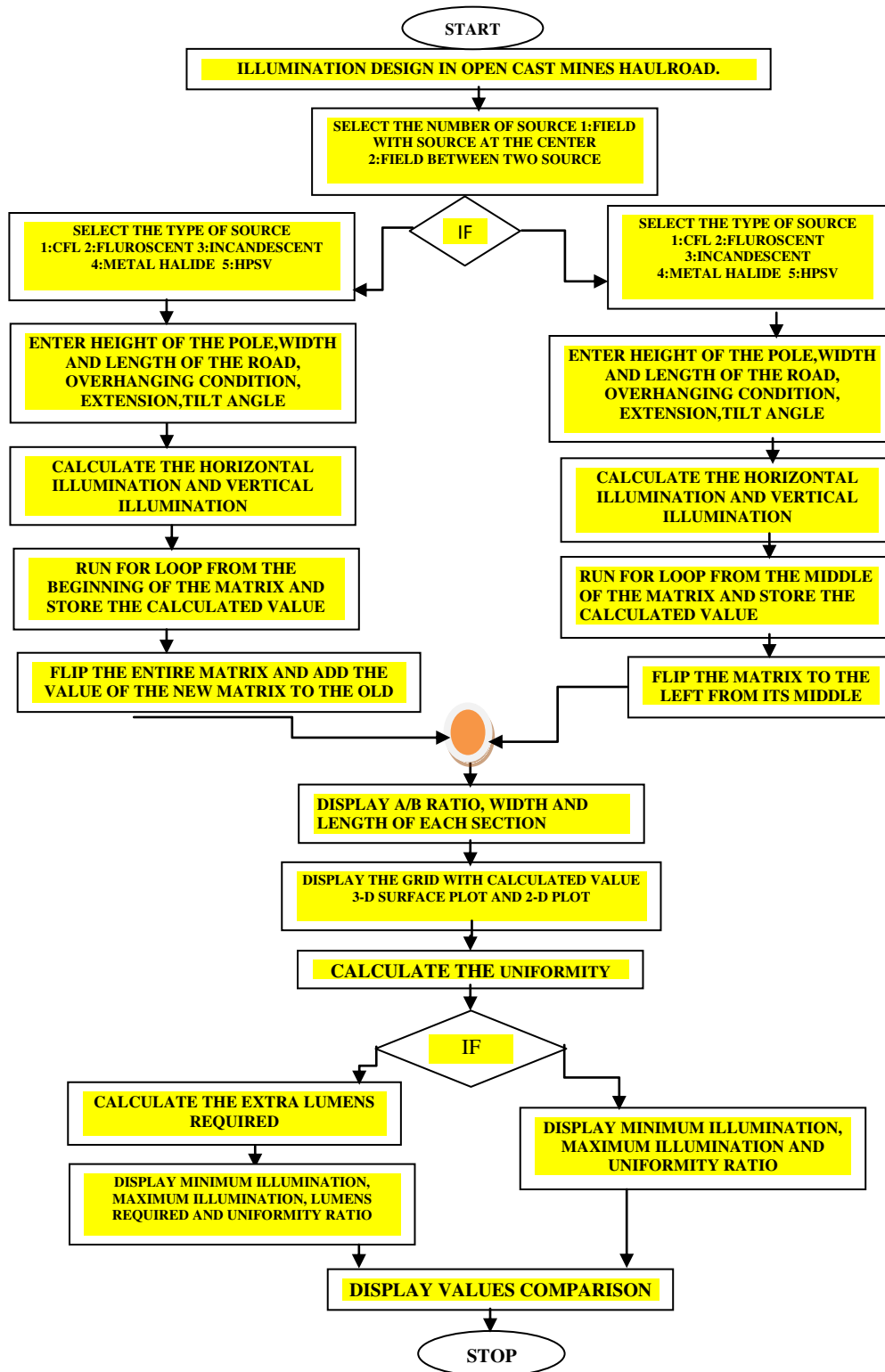

Fig. 4.3 Flowchart of computer program



Fig. 4.4 Fabricated light pole

and additional lumen required by the source (if $U_0 < 0.3$) are obtained as output of the computer model. In the present case, since new lamps were used, the utilization factor is taken as 0.95 and inverse maintenance factor is taken as 1.2. The output of the computer programme for this design is given in Annexure-II.



	4	3	2	1	0	1	2	3	4	5	0
•	3.82H 1.21V	4.73H 1.00V	5.56H 0.52V	6.20H 0.29V	6.19H 0.11V	6.21H 0.30V	5.58H 0.54V	4.75H 1.02V	3.84H 1.23V	3.10H 1.32V	1
•	3.97H 1.32V	4.76H 1.10V	5.51H 0.83V	6.13H 0.52V	6.12H 0.50V	6.15H 0.52V	5.53H 0.85V	4.78H 1.11V	3.99H 1.34V	3.22H 1.42V	2
•	3.82H 1.37V	4.48H 1.22V	5.12H 1.11V	5.52H 0.99V	5.58H 0.80V	5.51 0.97V	5.13H 1.13V	4.49H 1.24V	3.88H 1.38V	3.11H 1.36V	3
•	3.36H 1.39V	4.04H 1.37V	4.48H 1.24V	4.90H 1.18V	4.88H 1.21V	4.91H 1.19V	4.49H 1.26V	4.05H 1.39V	3.38H 1.37V	2.87H 1.32V	4
•	3.00H 1.32V	3.45H 1.36V	3.79H 1.37V	4.06H 1.26V	4.12H 1.34V	4.08H 1.29	3.77H 1.39V	3.47H 1.39V	3.01H 1.34V	2.51H 1.33V	5
•	2.52H 1.31V	2.81H 1.37V	3.20H 1.29V	3.35H 1.40V	3.32H 1.32V	3.35H 1.41V	3.23H 1.28V	2.83H 1.39V	2.55H 1.33V	2.16H 1.22V	6
•	2.11H 1.17V	2.35H 1.21V	2.59H 1.27V	2.62H 1.31V	2.72H 1.28V	2.64H 1.33V	2.58H 1.297V	2.37H 1.23V	2.14H 1.19V	1.83H 1.12V	7
•	1.72H 1.02V	1.85H 1.13V	2.11H 1.11V	2.18H 1.20V	2.21H 1.17V	2.19H 1.2V	2.14H 1.13V	1.88H 1.14V	1.74H 1.03V	1.51H 1.01V	8
•	1.42H 0.91V	1.45H 1.00V	1.62H 1.02V	1.72H 1.00V	1.78H 1.00V	1.74H 1.00V	1.65H 1.05V	1.46H 1.00V	1.45H 0.94V	1.29H 0.88V	9

Fig. 4.5 Measured horizontal and vertical lux levels

HEIGHT --- 8 M tilt angle --- 14 deg

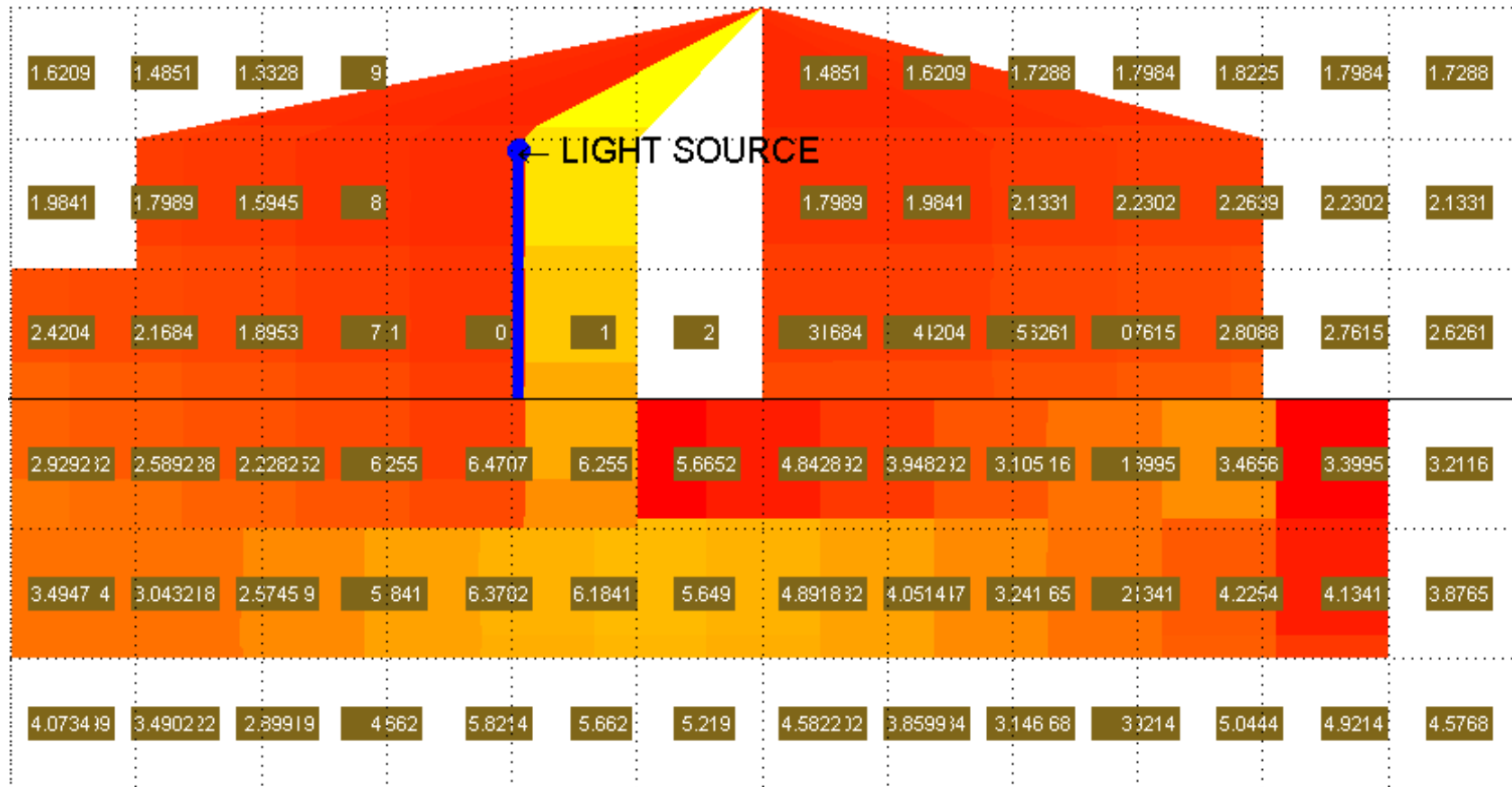

Fig. 4.6 Horizontal illuminance levels

HEIGHT --- 8 M tilt angle --- 14 deg

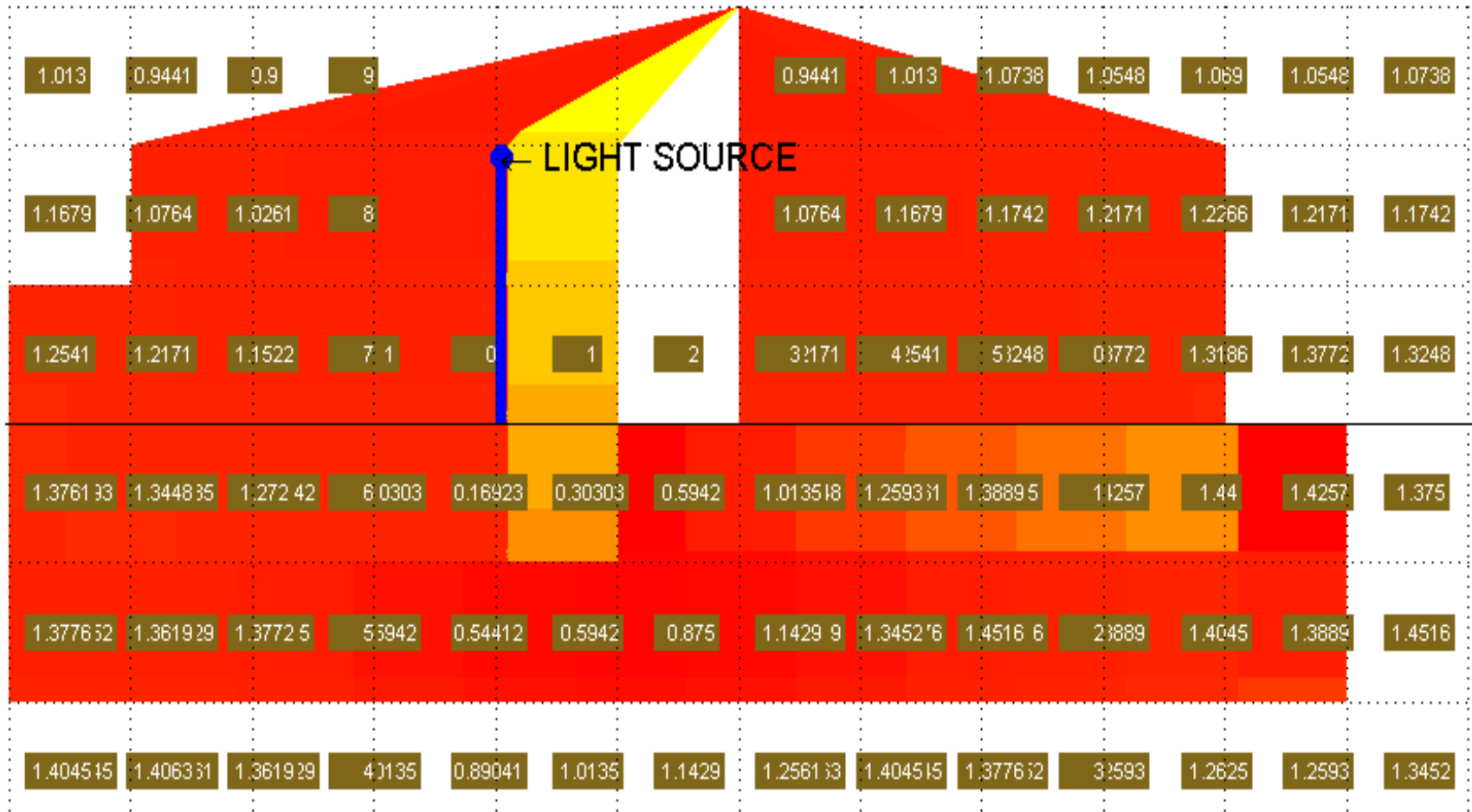

Fig. 4.7 Vertical illuminance levels

4.4.2 Measurement of horizontal and vertical lux levels for two 150 W HPSV lamps

The lux measurements were also made in a roadway in between two poles placed at an interval of 9m. both the poles consists of 150W HPSV sources mounted at a height of 8m from the surface, with 14° tilt angle. The light arm was 2m length and the sources were above the curb of the roadway. The surface area was divided into grids of size 1m x 1m. the grids were extended 9m along the length and 9m along the width of the roadways. The horizontal and vertical lux levels were measured at each grid point, which is shown in the Figure 4.8. Figure 4.9 and 4.10 shows the program output for the respective design parameters considered in the field. The results of the program were closely matching with the measured lux values, which are given in Figure 4.8. The average error was calculated as shown in Table 24 of Annexure -V (for both horizontal and vertical lux readings). The output of the computer programme for this design is given in Annexure-II.

	1	2	3	4	5	6	7	8	0	0
● 14.42H ● 2.21V	● 14.94H ● 2.82V	● 14.51H ● 3.52V	● 13.94H ● 4.14V	● 14.02H ● 5.10V	● 14.21H ● 5.13V	● 13.94H ● 4.14V	● 14.51H ● 3.52V	● 14.84H ● 2.85V	● 14.24H ● 2.13V	1
● 14.30H ● 3.10V	● 15.06H ● 2.96V	● 15.03H ● 4.03V	● 14.06H ● 5.01V	● 14.19H ● 5.23V	● 14.21H ● 5.30V	● 14.06H ● 5.01V	● 15.03H ● 4.03V	● 15.36H ● 2.68V	● 14.13H ● 3.13V	2
● 13.79H ● 3.37V	● 14.13H ● 3.43V	● 14.21H ● 4.52V	● 14.02H ● 5.12V	● 13.87H ● 5.29V	● 13.76H ● 5.24V	● 14.02H ● 5.12V	● 14.21H ● 4.52V	● 14.32H ● 3.33V	● 12.94H ● 3.38V	3
● 12.03 ● 4.20V	● 12.12H ● 4.09V	● 12.59H ● 5.01V	● 12.23H ● 5.28V	● 12.31H ● 5.37V	● 12.34H ● 5.33V	● 12.23H ● 5.28V	● 12.59H ● 5.01V	● 12.23H ● 4.03V	● 12.05H ● 4.27V	4
● 10.09H ● 4.13V	● 10.73H ● 4.18V	● 11.02H ● 5.04V	● 11.10H ● 5.06V	● 11.04H ● 5.31V	● 11.09H ● 5.34V	● 11.10H ● 5.06V	● 11.02H ● 5.04V	● 10.53H ● 4.13V	● 10.12H ● 4.16V	5
● 8.40H ● 3.95V	● 8.78H ● 4.36V	● 9.32H ● 4.28V	● 9.42H ● 5.00V	● 9.35H ● 5.05V	● 9.38H ● 5.09V	● 9.42H ● 5.00V	● 9.32H ● 4.28V	● 8.81H ● 4.29V	● 8.35H ● 3.92V	6
● 7.13H ● 4.01V	● 7.28H ● 4.05V	● 7.80H ● 4.15V	● 7.92H ● 4.21V	● 8.07H ● 4.18V	● 8.09H ● 4.16V	● 7.92H ● 4.21V	● 7.80H ● 4.15V	● 7.31H ● 4.01V	● 7.15H ● 4.32V	7
● 6.16 ● 3.31V	● 6.12H ● 3.72V	● 6.60H ● 3.82V	● 6.41H ● 4.05V	● 6.36H ● 4.06V	● 6.39H ● 4.09V	● 6.41H ● 4.05V	● 6.60H ● 3.82V	● 6.15H ● 3.77V	● 6.19H ● 3.34V	8
● 4.95H ● 3.19V	● 4.94H ● 3.18V	● 4.98H ● 3.19V	● 4.97H ● 3.15V	● 5.01H ● 3.18V	● 5.07H ● 3.15V	● 4.97H ● 3.15V	● 4.98H ● 3.19V	● 4.78H ● 3.16V	● 4.99H ● 3.12V	9

Fig. 4.8 Measured horizontal and vertical lux levels with two sources

HEIGHT --- 8 M tilt angle --- 14 deg

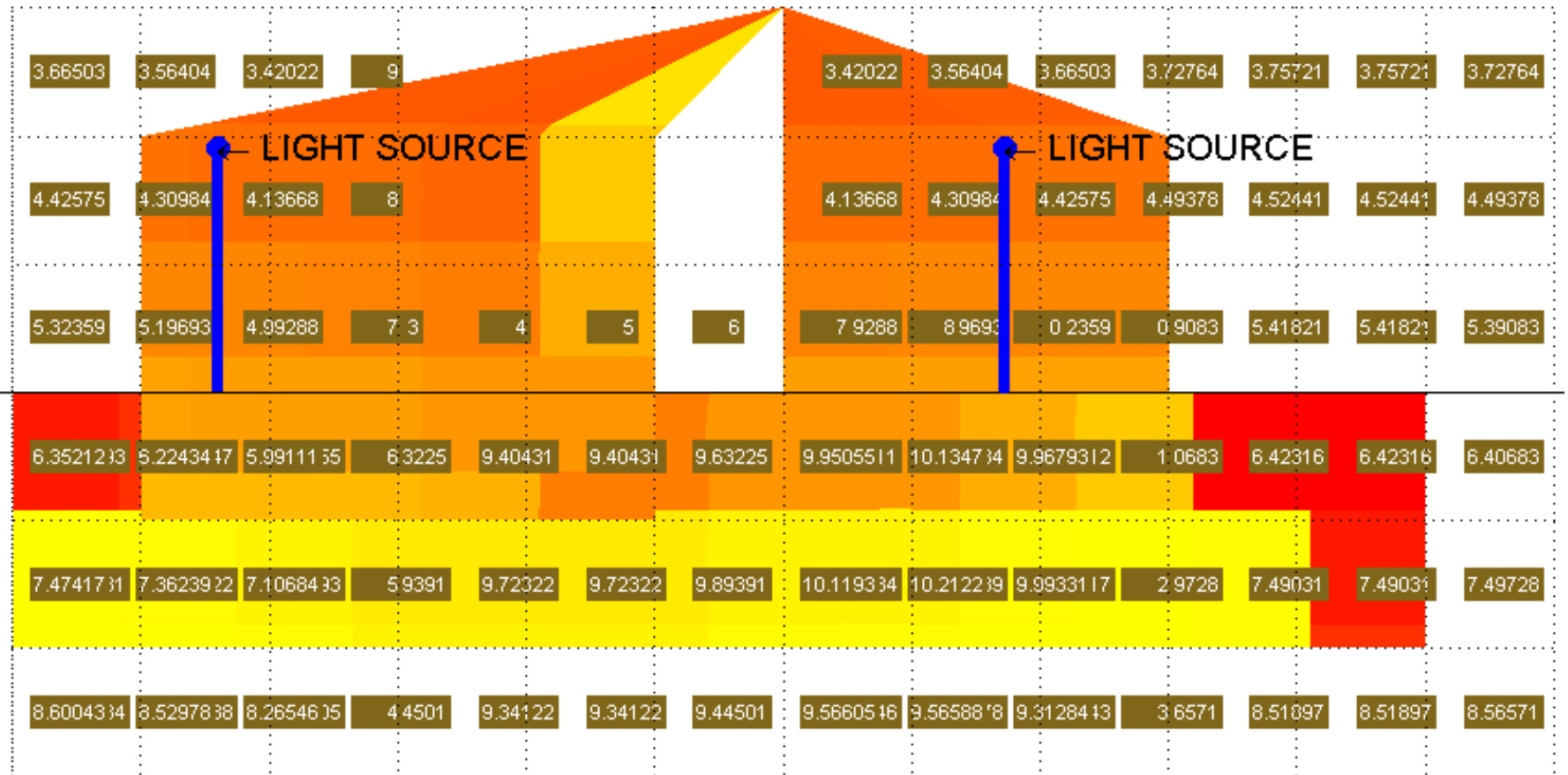

Fig. 4.9 Horizontal illumination levels

HEIGHT --- 8 M tilt angle --- 14 deg

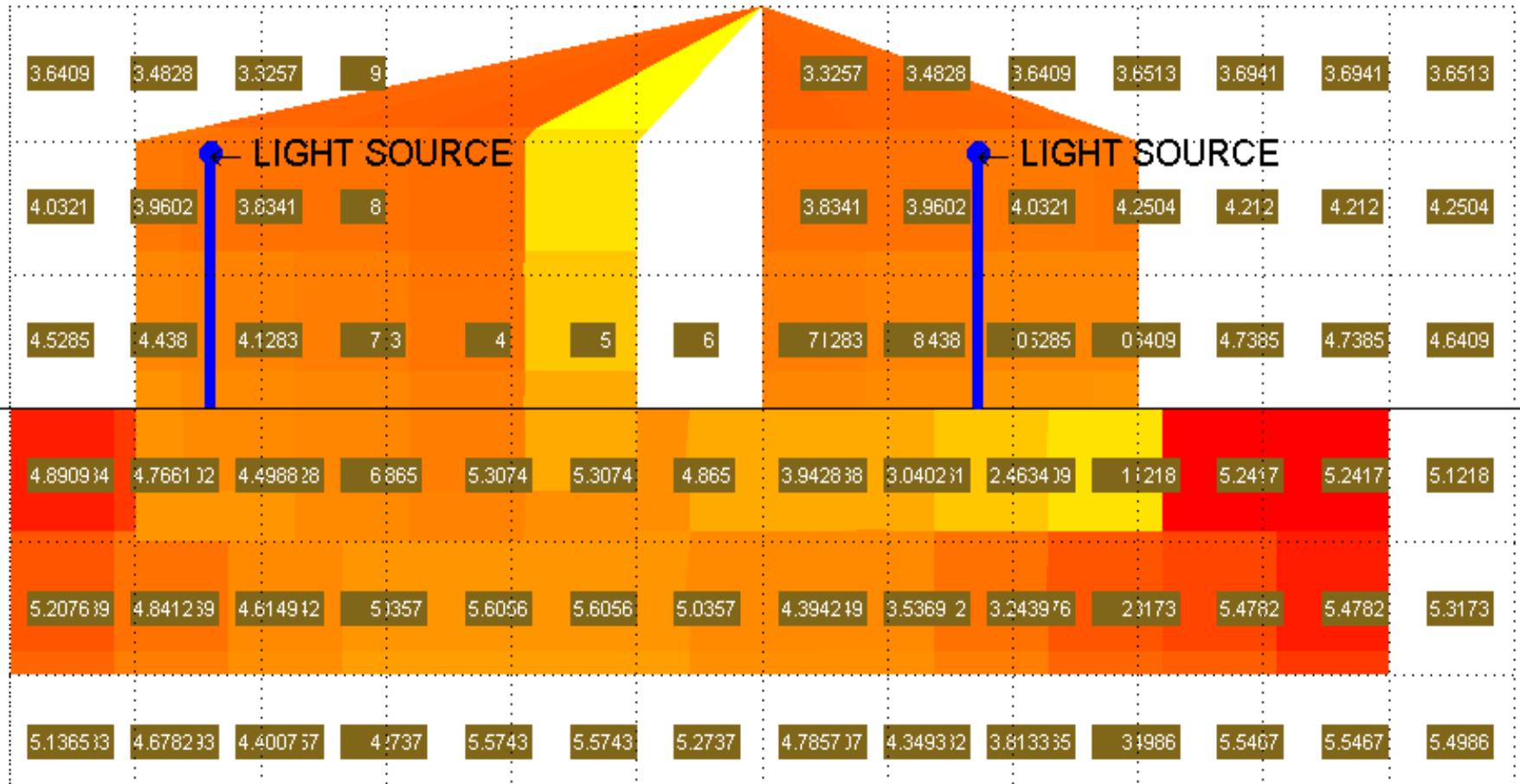

Fig. 4.10 Vertical illumination levels

CHAPTER-5

DEVELOPMENT OF COST MODEL

Importance of financial cost involvement cannot be over emphasized in any project. As far as industry is concerned a little change in the existing system may result in bringing very good environment, without much increase in the annual cost. Energy management and energy efficient design have tremendous impacts on cost. The final decision on which lighting system is to be installed should always be based on cost, which should not only include the initial cost of the installation, but also the annual running or operating cost. With the rising trend in energy cost and inflation in all sectors of the economy, a low initial investment system could cost the owner many times more to operate and maintain the system in the long run (Ronald et al., 1991).

5.1 Cost Evaluation of Illumination System

Many techniques have been proposed over the years for comparing the cost of different lighting (Anon et al., 1993). In general, any lighting project consists of two cost components i.e., initial investment cost and running cost. Initial investment cost involves both material cost and installation cost. As stated by the Lighting Service Bureau, London. Once a lighting system has been installed its running cost (other than for labor on maintenance) is made up of two principal items - cost of lamp replacements and cost of power consumed by them (Anon et al., 1948). In general, cost comparison of lighting systems are made based on their total annual cost, which consists of three cost components, namely fixed annual cost, running cost and maintenance cost per year (Lyons et al., 1981). In lighting projects salvage value of installation accessories like luminaires, poles, cables etc. is practically zero, and hence not considered in cost evaluation (Barr et al., 1952).

5.2 Formulation of Cost Model

As stated, total annual cost (TAC) of lighting system consists of three components, namely fixed annual cost (FAC), annual running cost (ARC) and annual maintenance cost (AMC) (Barr et al., 1952; Anon et al., 1948; Lyons et al., 1981; Ronald et al., 1991; Anon et al.,

1993). Equation (5.1) indicates the equation for total annual cost.

$$TAC = FAC + ARC + AMC \quad (5.1)$$

(i) Fixed annual cost

Fixed annual cost comprises of annual depreciation and annual interest on luminaires, poles and cables and is given by:

$$FAC = ADL + AIL + ADP + AIP + ADC + AIC \quad (5.2)$$

where,

ADL - annual depreciation on luminaires, which is calculated as:

$$ADL = [(TL - SL) \times R \div 100] \div [(1 + R \div 100)^{N_L} - 1] \quad (5.3)$$

where,

SL - salvage value of luminaire, ₹

R - interest rate, %

N_L - life of luminaire, yr and

TL - initial cost of luminaires, ₹ which is calculated as:

$$TL = \Sigma (NLT \times PL) \quad (5.4)$$

where,

Σ - summation over all types of luminaries (throughout this mathematical model)

NLT - number of luminaires (fixtures) of a particular type and

PL- unit price of luminaire, ₹

AIL- annual interest on luminaires, which is calculated as:

$$AIL = TL \times R \div 100 \quad (5.5)$$

ADP - annual depreciation on poles, which is calculated as:

$$ADP = [(TP - SP) \times R \div 100] \div [(1 + R \div 100)^{N_P} - 1] \quad (5.6)$$

Where,

SP- salvage value of pole, ₹

N_P - life of pole, yr and

TP - initial cost of poles, ₹ which is calculated as:

$$TP = (PC + PIC + PFC + PFIC) \times TNP \quad (5.7)$$

where,

PC - unit pole cost, ₹

PIC - unit pole installation cost, ₹

PFC - unit pole fittings cost, ₹

PFIC - unit pole fittings installation cost, ₹ and

TNP - total number of poles

AIP- Annual interest on poles, which is calculated as:

$$AIP = TP \times R \div 100 \quad (5.8)$$

ADC - Annual depreciation on cable, which is calculated as:

$$ADC = [(TC - SC) \times R \div 100] \div [(1 + R \div 100)^{L_{oc}} - 1] \quad (5.9)$$

Where,

SC - salvage value of cable, ₹

L_{oc} - life of cable, yr, and

TC - initial cabling cost, ₹, which is calculated as:

$$TC = (CC \times TLC) + (CL + TLC) \quad (5.10)$$

where,

CC- cable cost, ₹ per km,

TLC - total length of cable, km and

CL - cable laying cost, ₹ per km.

AIC - Annual interest on cable, which is calculated as:

$$AIC = TC \times R \div 100 \quad (5.11)$$

(ii) Annual running

Running cost per year is calculated under three heads:

$$ARC = LC + EN + LCL \quad (5.12)$$

Where,

LC - lamp replacement cost per year, which is calculated as:

$$LC = (\sum[(LP \times NL \times NLT) \div ALL]) \times BH \quad (5.13)$$

Where

LP - unit price of lamp, ₹

N_{OL} - number of lamps in the particular luminaire,

NLT- number of luminaires of a particular type,

ALL - average lamp life of a particular type, hr and

BH- burning hours per year of the switching mode.

EN - energy cost per year, ₹ which is calculated as:

$$EN = (KWHPR \div 1000) \times (\sum[NLT (WNLT + BL)]) \times BH \quad (5.14)$$

where,

KWHPR- kilowatt-hour price, ₹

WNLT - total watts per luminaire of a particular type and

BL - ballast loss per luminaire, W

LCL - labour cost for lamp replacement per year, ₹ which is calculated as:

$$LCL: (\sum [(NL \times NLT) \div ALL] \times RL) \times BH \quad (5.15)$$

where,

RL - labour cost per lamp replacement, ₹

iii) Annual maintenance cost

Maintenance cost per year, ₹ which is given by:

$$AMC = (MCL \times NC \times TNL) \quad (5.16) \text{ where,}$$

MCL - maintenance cost per luminaire, ₹

NC - number of cleanings per annum and

TNL - total number of luminaires.

5.3 Development of Computer Program for Cost Evaluation

For economic analysis of the lighting system a computer program has been developed in MATLAB language. A simplified flow chart of the program is shown in Figure 5.1 Using this model the total costs of roadway lighting installations, employing different types of lamps, can be calculated. The input parameters for the cost program have been considered as per Karnataka Public Works Department Schedule of Rates (KPWDSR 2014-15) norms. The total cost of the system calculated under two heads: total investment cost and the annual running cost.

As discussed earlier using design program maximum pole spacing is determined for the installations considered, for a given pole height and luminaire distribution, in compliance with required lighting standards. With such iterative design layouts, the minimum number needed for total length of a haul road is calculated and the cost involved for each type of lighting system is computed using cost program. While calculating the number of poles, fractional number has been rounded off to the nearest integer and it has been increased by

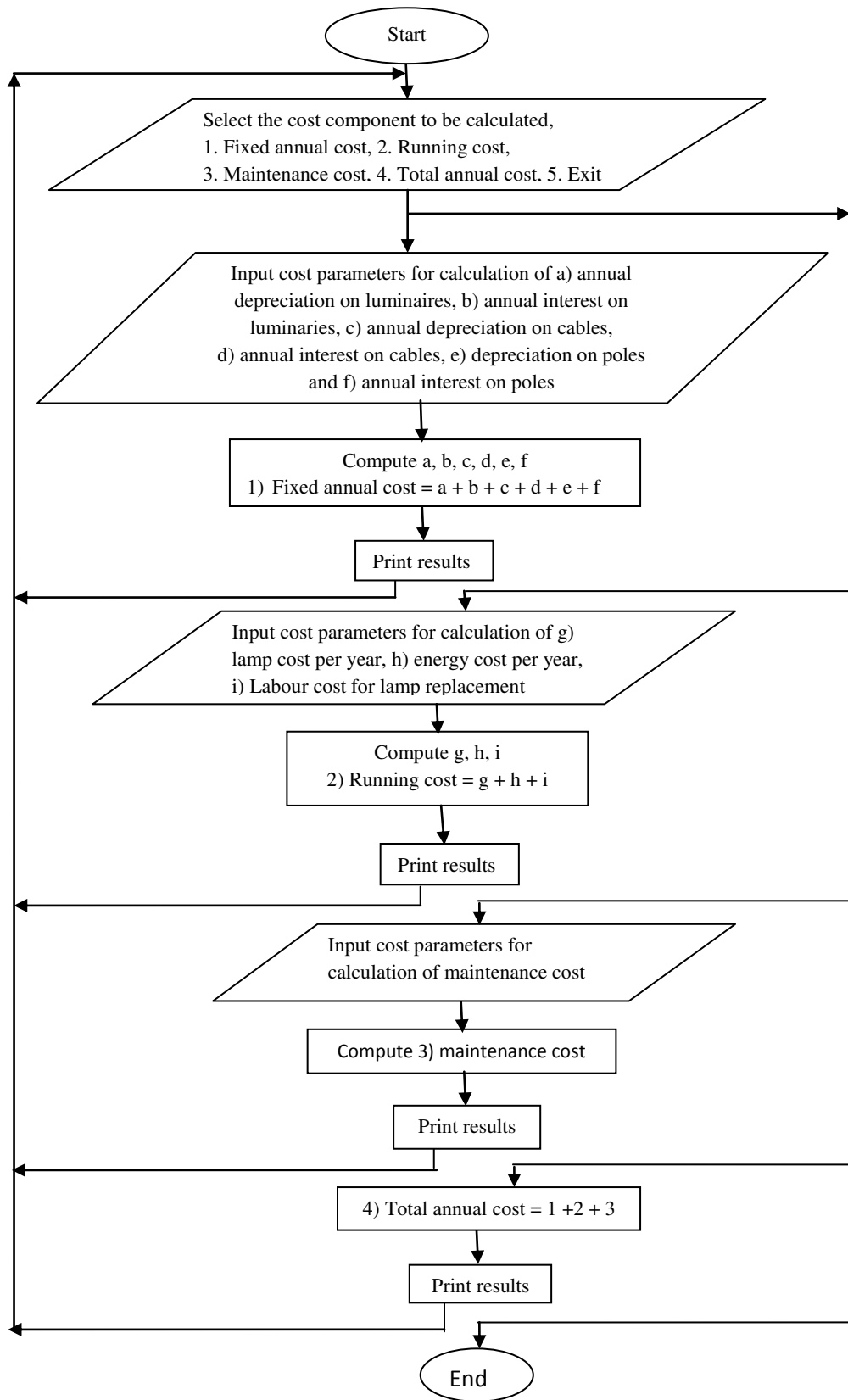

Fig. 5.1 Simplified flow chart for cost calculations

one to have poles at both the ends of the road wherever necessary. The spacing between the poles has to be readjusted accordingly. Total cost involvement for all the feasible layouts is compared and the one with least cost gives the optimum design layout.

CHAPTER-6

OPTIMIZATION OF LIGHTING DESIGN PARAMETERS

As explained in the earlier Chapter-3, good artificial lighting system influences the condition of seeing, which facilitates in reducing worker's fatigue, protecting their health, eyes and nervous system, and reducing accidents. These benefits tend to offset the cost economics of lighting or it may be many times greater than the cost of the lighting (Lyons, 1981). The selection of artificial light installations for a particular job is very important. The lighting parameters such as type of lamp, luminaire, reflectors and mirrors, lumen output, wattage of the source and its life, luminaire layout etc. are important in the design of the lighting system for any project (Lyons, 1981).

The lighting designer should consider the following design parameters, such as lamp orientation, etc. mounting height, tilt angle, light arm length, pole intervals, so as to fulfill the minimum lighting standards in the working place. These design parameters should be optimized to minimize the power consumption as well as the cost (Bommel et al., 1980).

6.1 Optimization of Design Parameters Using 150W HPSV Source

For the optimization of tilt angle, arm length and mounting height, a light pole was considered 2m beyond the kerb of the roadway of 9m width. For the purpose of comparison, three arm lengths were considered, i.e. 2m, 1m and 0m (i.e. source is directly mounted on the pole). The tilt angle of the arm was varied from 0° to 30° at 5° interval. The literature review as well as the field experience indicates that the optimum tilt angle for any source is generally lies in between 10° to 15°. In this regard, the illuminance levels were also computed for 11°, 12°, 13° and 14° tilt angles. In general, as a thumb rule, the height of pole should be equal or near to the width of the roadway for uniform distribution of light across it (as discussed in Section 3.2.1). In this regard, for 9m wide roadway five mounting heights, such as 8m, 9m, 10m, 11m and 12m were selected. With the help of developed computer model, the grids (of 1m x 1m size) were prepared across the width and length of the road, and illuminance levels were noted at the center of the roadway along the axis of the pole for

150W HPSV source. The pole height was varied from 8m to 12m at 1m interval, and the design was made for different combination of light arm length and tilt angle.

6.1.1 Variation of tilt angle and arm length at 8 m mounting height

Table 6.1 indicates the computed values of lux levels for the source mounted at 8m height. The readings were noted for 0m, 1m and 2m arm lengths by varying the tilt angle from 0° to 30°. The influence of tilt angle on illuminance levels is shown in Figure 6.1.

Table-6.1: Illuminance levels with 8m mounting height

Tilt angle (in degree)	Illuminance levels (in lux)		
	Arm length 0m	Arm length 1m	Arm length 2m
0	1.01	0.71	0.52
5	1.09	0.89	0.73
10	3.12	2.67	1.89
11	4.68	4.38	3.92
12	9.36	7.38	5.54
13	13.09	9.37	7.38
14	17.25	11.48	9.4
15	13.15	10.77	9.35
20	3.04	2.56	2.11
25	2.28	1.61	1.17
30	1.59	1.37	1.16

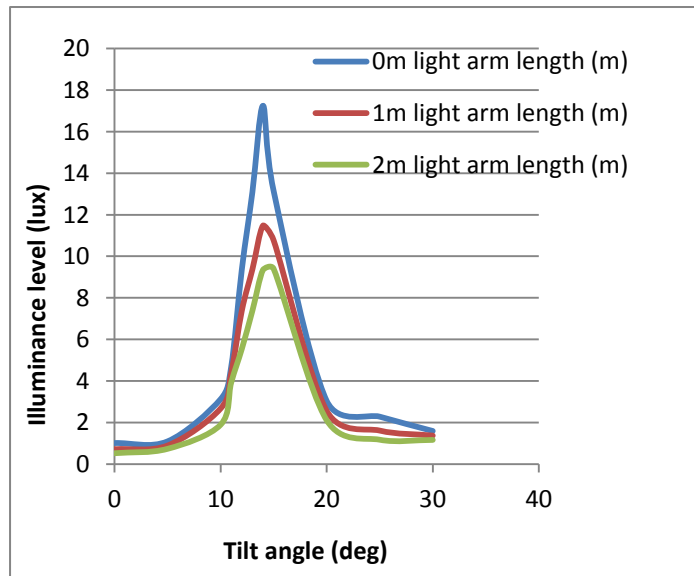

Fig. 6.1 Influence of tilt angle on illuminance levels for different arm length at 8m pole height

It is evident from the Figure 6.1, the illuminance levels ranging from 0.52 to 1.89lux with the change in tilt angle from 0 to 10°. Beyond 10° tilt angle, there is a rapid increase in the illuminance level and it is reported to be maximum at 14° tilt angle it is mainly due to typical characteristics of a lamp (its shape and photometric data). Beyond 14° tilt angle, i.e. from 15° to 30°, the illuminance level is in the range from 9.35 to 1.16lux. Among 0m, 1m and 2m arm lengths, maximum lux level was reported for 0m arm length at 14° tilt angle.

6.1.2 Variation of tilt angle and arm length at 9m mounting height

Table 6.2 indicates the computed values of lux levels for the source mounted at 9m height. The readings were noted for 0m, 1m and 2m arm lengths by varying the tilt angle from 0° to 30°. The influence of tilt angle on illuminance levels is shown in Figure 6.2. It

Table-6.2: Illuminance levels with 9m mounting height

Tilt angle (in degree)	Illuminance levels (in lux)		
	Arm length 0m	Arm length 1m	Arm length 2m
0	0.79	0.58	0.42
5	0.79	0.65	0.55
10	2.24	2.09	1.61
11	3.11	3.02	2.79
12	8.09	5.96	4.4
13	12.02	8.96	6.62
14	16.43	10.8	8.8
15	3.73	2.15	2.59
20	2.14	1.68	1.58
25	1.52	1.31	0.96
30	1.11	1.23	0.85

is evident from the Figure 6.2, the illuminance levels ranging from 0.42 to 1.61lux with the change in tilt angle from 0 to 10°, whereas the illuminance level increases with the increase in tilt angle from 10° to 14°. Beyond 14° tilt angle, i.e. from 15° to 30°, the illuminance level reduces, which is in the range from 2.59 to 0.85lux and it is mainly due to typical characteristics of a lamp (its shape and photometric data). Among 0m, 1m and 2m arm lengths, maximum lux level was reported for 0m arm length at 14° tilt angle.

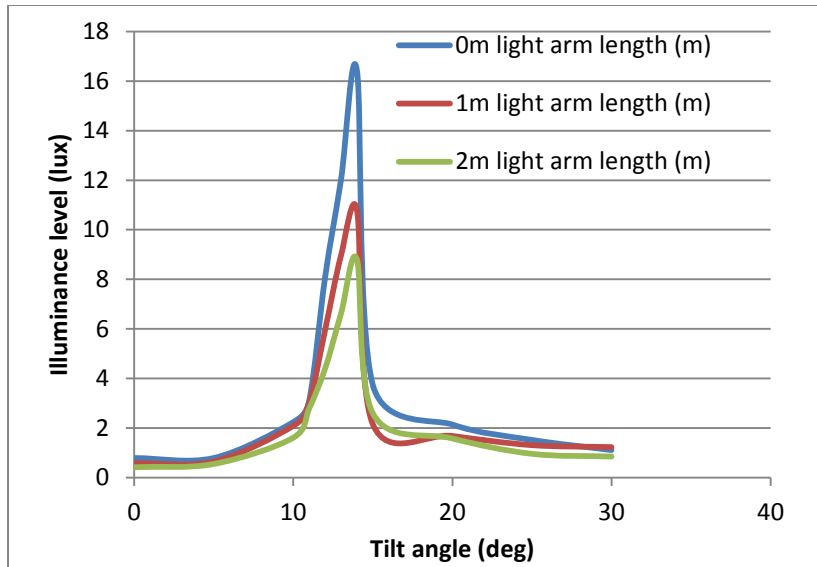

Fig. 6.2 Influence of tilt angle on illuminance levels for different arm length at 9m pole height

6.1.3 Variation of tilt angle and arm length at 10m mounting height

Table 6.3 indicates the computed values of lux levels for the source mounted at 10m height. The readings were noted for 0m, 1m and 2m arm lengths by varying the tilt angle from 0° to 30°. The influence of tilt angle on illuminance levels is shown in Figure 6.3. It is evident from the Figure 6.3, the illuminance levels ranging from 0.35 to 1.45lux with the change in

Table-6.3: Illuminance levels with 10m mounting height

Tilt angle (in degree)	Illuminance levels (in lux)		
	Arm length 0m	Arm length 1m	Arm length 2m
0	0.53	0.46	0.35
5	0.58	0.5	0.42
10	1.2	1.1	1.45
11	2.11	2.09	2.01
12	7.1	4.12	3.69
13	10.56	6.93	4.92
14	14.07	8.5	7.5
15	9.6	6.87	6.54
20	1.54	1.38	1.2
25	1.23	1.06	0.8
30	0.96	0.72	0.64

tilt angle from 0 to 10°, whereas the illuminance level increases with the increase in tilt angle from 10° to 14°. Beyond 14° tilt angle, i.e. from 15° to 30°, the illuminance level reduces,

which is in the range from 6.54 to 0.64lux. Among 0m, 1m and 2m arm lengths, maximum lux level was reported for 0m arm length at 14° tilt angle.

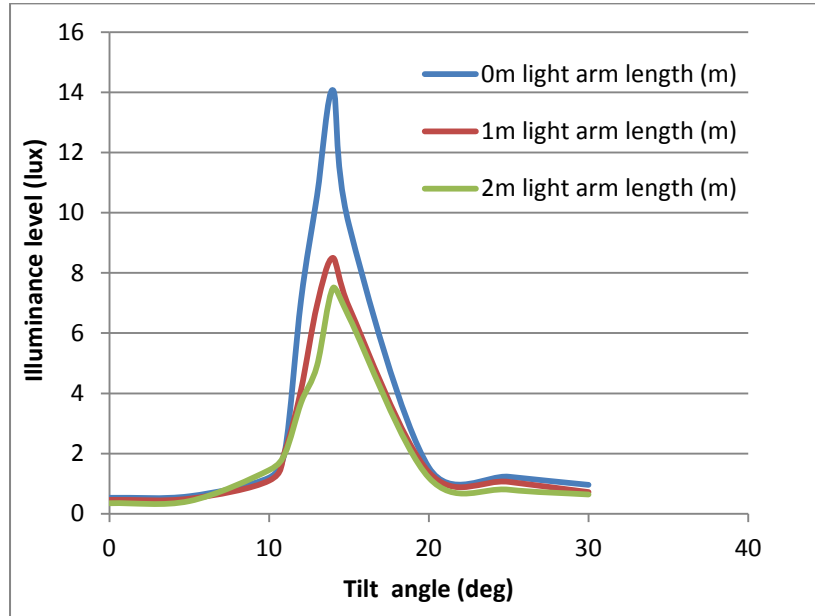

Fig. 6.3 Influence of tilt angle on illuminance levels for different arm length at 10m pole height

6.1.4 Variation of tilt angle and arm length at 11m mounting height

Table 6.4 indicates the computed values of lux levels for the source mounted at 11m height. The readings were noted for 0m, 1m and 2m arm lengths by varying the tilt angle from 0° to 30°. The influence of tilt angle on illuminance levels is shown in Figure 6.4. It is evident from the Figure 6.4, the illuminance levels ranging from 0.63 to 2.09lux with the change in

Table-6.4: Illuminance levels with 11m mounting height

Tilt angle (in degree)	Illuminance levels (in lux)		
	Arm length 0m	Arm length 1m	Arm length 2m
0	1.25	0.89	0.63
5	1.71	1.23	0.97
10	2.19	2.15	2.09
11	2.9	3.46	3.55
12	8.61	6.51	5.81
13	12.88	9.24	8.16
14	15.37	10.13	8.83
15	4.19	4.22	3.95
20	2.08	2.26	1.81
25	1.83	1.42	1.43
30	1.3	1.24	1.19

tilt angle from 0 to 10°. The illuminance level increases with the increase in tilt angle from 10° to 14°. Beyond 14° tilt angle, i.e. from 15° to 30°, the illuminance level reduces, which is in the range from 3.95 to 1.19lux. Among 0m, 1m and 2m arm lengths maximum lux level was reported for 0m arm length at 14° tilt angle.

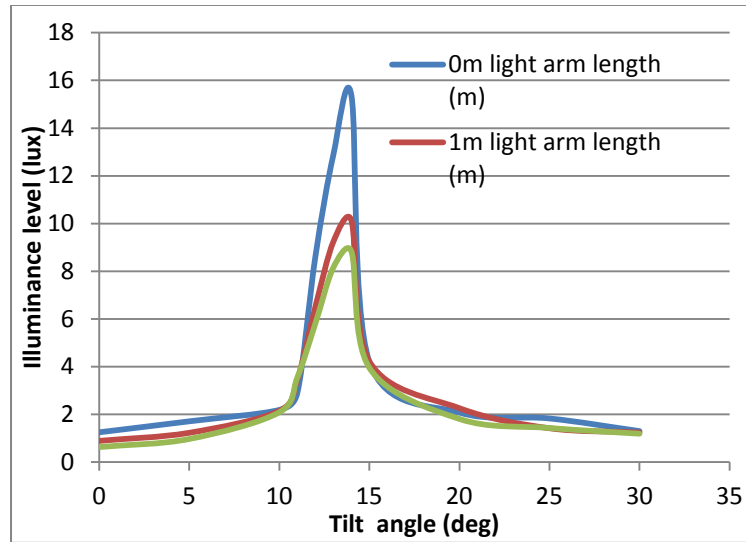

Fig. 6.4 Influence of tilt angle on illuminance levels for different arm length at 11m pole height

6.1.5 Variation of tilt angle and arm length at 12m mounting height

Table 6.5 indicates the computed values of lux levels for the source mounted at 12m height. The readings were noted for 0m, 1m and 2m arm lengths by varying the tilt angle from 0° to 30°. The influence of tilt angle on illuminance levels is shown in Figure 6.5. It is evident from the Figure 6.5, the illuminance levels ranging from 0.29 to 0.43lux with the change in tilt angle from 0 to 10°. The illuminance level increases with the increase in tilt angle from 10° to 14°, as explained in section 3.2.4. Beyond 14° tilt angle, i.e. from 15° to 30°, the illuminance level reduces, which is in the range from 2.4 to 0.48lux. Among 0m, 1m and 2m arm lengths, maximum lux level was reported for 0m arm length at 14° tilt angle. As shown in the above graphs (i.e. in Figures 6.1 to 6.5), the lux levels is maximum at 14° tilt angle and 0m arm length for 8m, 9m, 10m, 11m and 12m mounting heights. Further, it is also noted that at 14° tilt angle the illuminance level is above the minimum required lux level of 0.5, across the roadway. Based on these results, the optimum lighting parameters i.e. tilt angle, arm length and mounting height for 9m width roadway would be 14°, 0m and 8m, respectively.

Table-6.5: Illuminance levels with 12m mounting height

Tilt angle (in degree)	Illuminance levels (in lux)		
	Arm length 0m	Arm length 1m	Arm length 2m
0	0.5	0.38	0.29
5	0.43	0.37	0.32
10	0.91	0.69	0.43
11	1.46	1.5	1.46
12	5.53	3.83	2.98
13	9.72	5.95	4.65
14	12.81	7.27	5.38
15	3.43	2.8	2.4
20	1.03	1.04	0.72
25	0.97	0.88	0.67
30	0.58	0.53	0.48

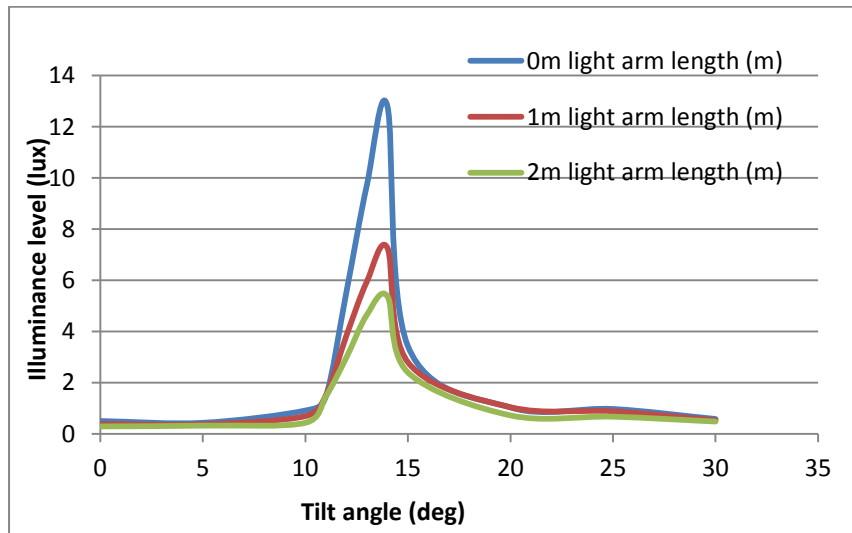

Fig. 6.5 Influence of tilt angle on illuminance levels for different arm length at 12m pole height

6.2 Optimization of Pole Interval

The light poles in general were arranged on one side of haul road. The height of poles is the main criteria in deciding the spacing between adjacent poles, which in turn depends upon the width of road. In practice, pole interval is optimized to yield required lighting standards between two adjacent poles and then total number of poles required for the whole length of haul road is calculated. Sometimes sources may not be compatible with height of pole. In such cases, it may not be possible to achieve all the lighting design parameters satisfying the

standards or else the required pole interval may be so less so that the design is not economically feasible (Glanville et al., 1960; Bommel et al., 1980).

For optimization of pole interval a haul road of width 12m (which generally exists in the mines) is considered. Using developed computer design model, lighting system is designed for this haul road with six types of luminaries of different wattages, namely - 100W CFL, 2x40W FTL, 80, 125, 150 and 250W HPMV, 70, 150 and 250W MH, 70, 100, 150, 250 and 400W HPSV, 24, 42, 72, 90, 120, 150, 250 and 300W LED lamps. Lamp mounting heights have been varied at five steps, namely 8m, 10m, 12m, 14m and 16m, so as to compatible with the road width. Tilt angle of luminaire was kept at 14° with 0m light arm length (optimum design parameters as obtained in Section 6.1). Grids were selected as per CIE standardization (CIE, 1999).

The maximum pole spacing was determined for a given pole height and luminaire characteristics, in compliance with the required lighting standards (0.5lux minimum illuminance level as per DGMS and 0.3 uniformity ratio as per CIE). A representative computer output of the design model for 70W HPSV sources is shown in Figures 6.6(a), 6.6(b) and 6.6(c). Figure 6.6(a) shows the input parameters for the programme, Figure 6.6(b) gives the horizontal lux levels at grid points and Figure 6.6(c) is the final output of the programme. As shown in the Figure 6.6(c), at 19m pole interval the minimum lux level is 1.3 with 0.37 uniformity ratio. This satisfies the minimum lux level (i.e. 0.5lux) as required by DGMS standards. Further, uniformity ratio (i.e. 0.3) is also fulfilled as per BIS and CIE standards. Similarly design was made for all type of sources, which are mentioned above, for different mounting heights. Table 6.6 gives the optimum pole intervals for different types of sources at 8m, 10m, 12m, 14m and 16m pole heights.

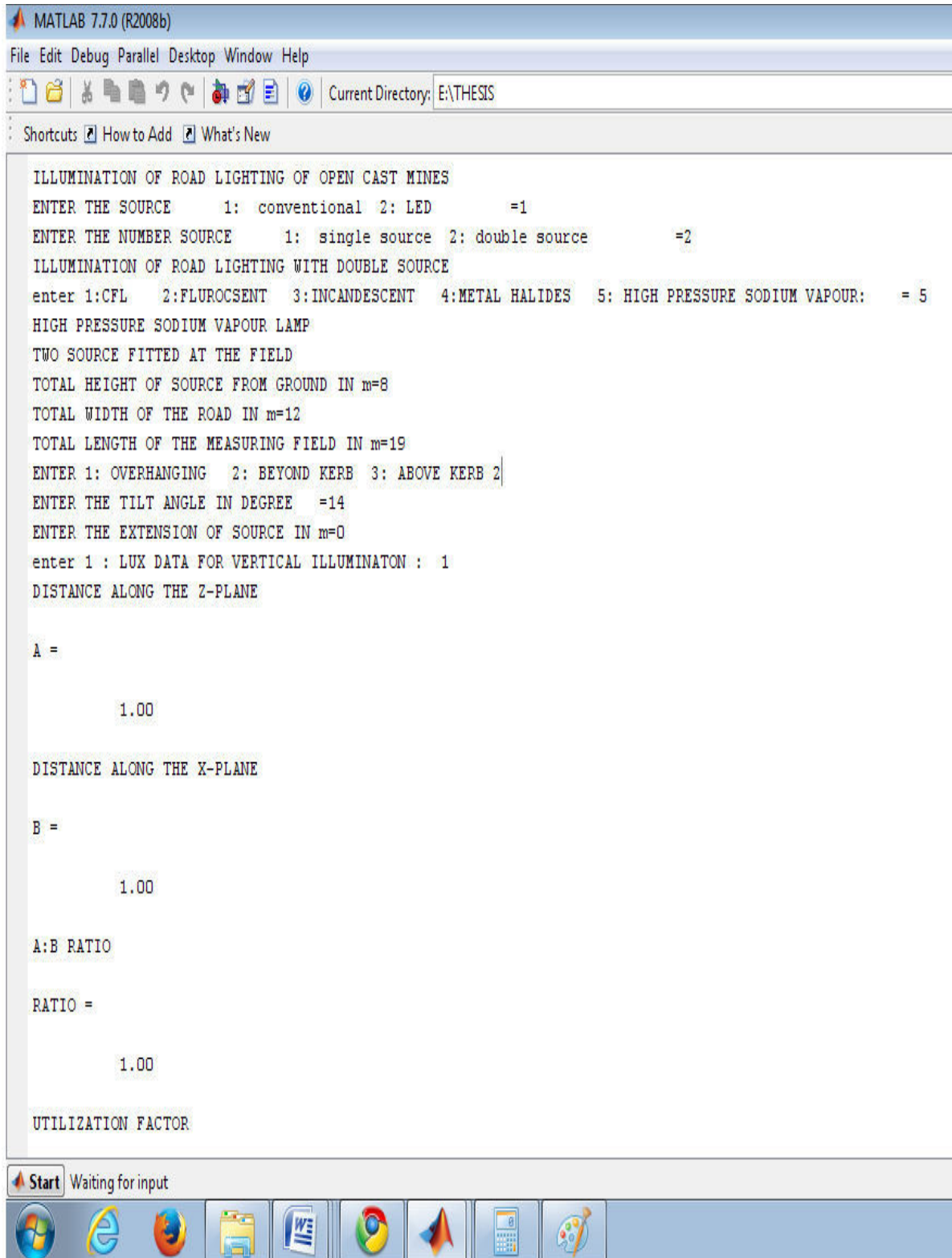

Fig. 6.6(a) Input design parameters for the computer programme

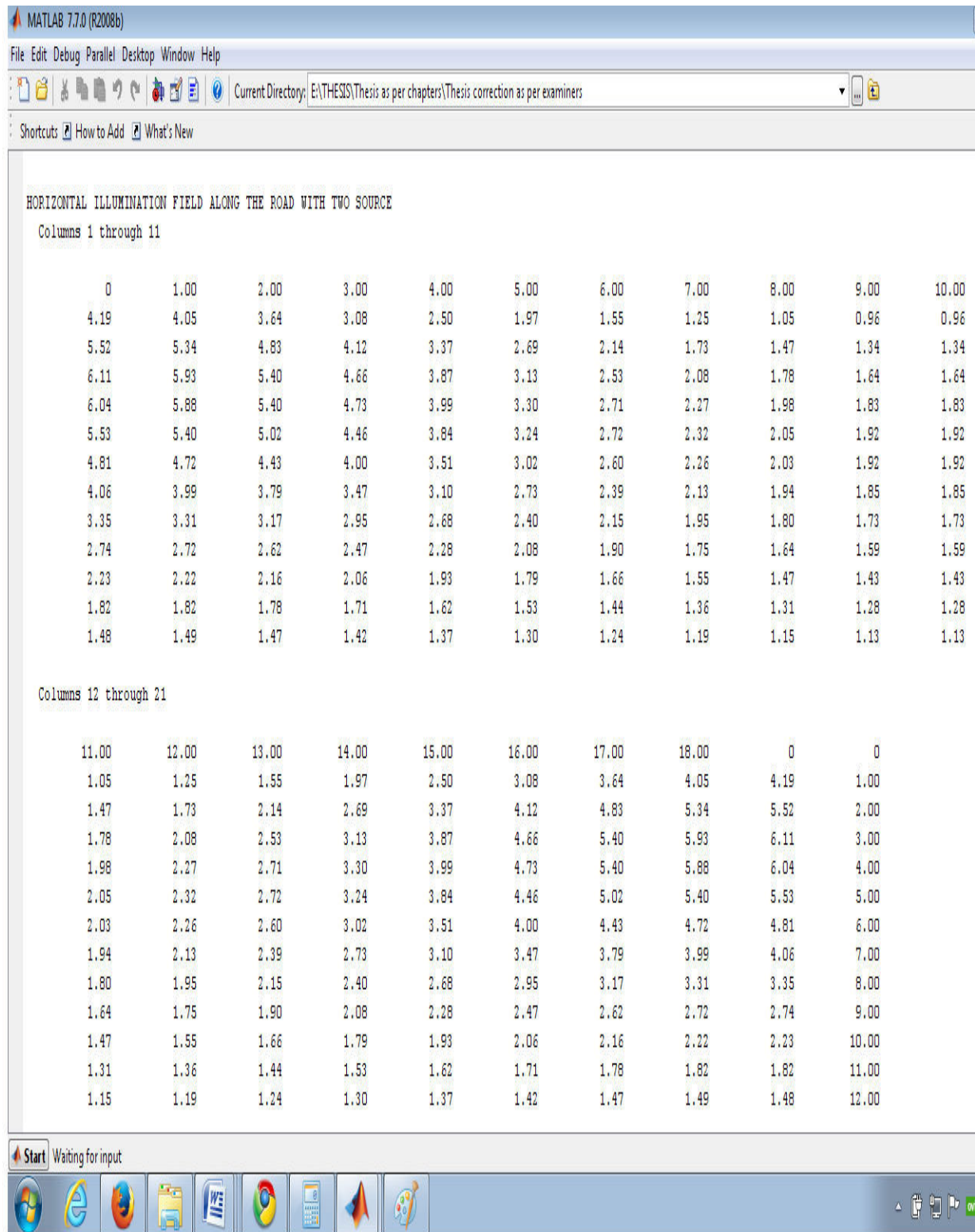

Fig. 6.6(b) Computer output for horizontal lux levels between two poles

```
HORIZONTAL ILLUMINATION MEAN
    3.30

UNIFORMITY RATIO

max_illumination =

    6.11

min_illumination =

    0.96

UNIFORMITY_RATIO =

    0.29
```

Start Waiting for input



Fig. 6.6(c) Output of the computer programme

Table-6.6: Optimum pole spacing for different types of sources

Type of source	Wattage (inW)	Mounting height of poles (in m)				
		8	10	12	14	16
		Pole spacing (in m)				
CFL	100W	17	17	14	*	*
FTL	2X40W	18	17	15	*	*
HPMV	80W	16	15	10	*	*
	125W	18	17	14	*	*
	150W	18	18	16	13	*
	250W	19	20	19	16	10
MH	70W	17	16	13	*	*
	150W	19	19	18	15	*
	250W	20	21	20	19	16
HPSV	70W	19	19	17	14	*
	100W	19	20	18	16	*
	150W	20	21	21	20	17
	250W	21	22	23	22	21
	400W	21	23	24	25	24
LED	24W	17	16	13	*	*
	42W	18	18	17	13	*
	72W	19	20	19	18	13
	90W	20	21	21	20	16
	120W	20	21	22	21	19
	150W	20	22	23	22	20
	250W	21	23	24	25	23
	300W	21	23	24	25	24

*design parameters not satisfying minimum lighting standards

6.3 Design Based on Optimal Energy Considerations

To compare various types of lighting systems, a stretch of 1.0km length of haul road of 12m width was considered, which is quite common in surface mines. The lighting system was designed for this road length with various types of sources (as mentioned in Section 6.2) by incorporating the design parameters as given in Table 6.6. By knowing optimum pole

intervals, the total number of poles/sources required for illuminating 1.0 km stretch roadway was calculated. Based on number of sources total annual energy consumption was calculated for all types of light sources under consideration. Table 6.7 gives the total annual energy consumption for different types of lighting systems.

Table-6.7: Optimum total annual energy consumption for different types of lighting sources

Type of source	Height of the pole (m)	No. of Poles	Total wattage (W)	Energy Consumption Per annum (KW-hr)
100W CFL	8	59	5900	25842
	10	59	5900	25842
	12	71	7100	31098
	14	-	-	-
2x40W FTL	8	56	4480	19622.4
	10	59	4720	20673.6
	12	67	5360	23476.8
	14	-	-	-
80W HPMV	8	63	5040	22075.2
	10	67	5360	23476.6
	12	100	8000	35040
	14	-	-	-
125W HPMV	8	56	7000	30660
	10	59	7375	32302.5
	12	71	8875	38872,5
	14	-	-	-
150W HPMV	8	56	8400	36792
	10	56	8400	36792
	12	63	9450	41391
	14	77	11550	50589
	16	-	-	-
250W HPMV	8	53	13250	58035
	10	50	12500	54750
	12	53	13250	58035

Contd.

	14	63	15750	68985
	16	100	25000	109500
70W MH	8	59	4130	18089.4
	10	63	4410	19315.8
	12	77	5390	23608.2
	14	-	-	-
150W MH	8	53	7950	34821
	10	53	7950	34821
	12	56	8400	36792
	14	67	10050	44019
	16	-	-	-
250W MH	8	50	12500	54750
	10	48	12000	52560
	12	50	12500	54750
	14	53	13250	58035
	16	63	15750	68985
70W HPSV	8	53	3710	16249.8
	10	53	3710	16249.8
	12	59	4130	18089.4
	14	71	4970	21768.6
	16	-	-	-
100W HPSV	8	53	5300	23214
	10	50	5000	21900
	12	56	5600	24528
	14	63	6300	27594
	16	-	-	-
150W HPSV	8	50	7500	32850
	10	48	7200	31536
	12	48	7200	31536
	14	50	7500	32850
	16	59	8850	38763
250W HPSV	8	48	12000	52560
	10	45	11250	49275

	12	43	10750	47085
	14	45	11250	49275
	16	48	12000	52560
400W HPSV	8	48	19200	84096
	10	43	17200	75336
	12	42	16800	73584
	14	40	16000	70080
	16	42	16800	73584
24 W LED	8	59	1416	6202.08
	10	62	1488	6517.44
	12	77	1848	8094.24
	14	-	-	-
42 W LED	8	56	2352	10301.76
	10	56	2352	10301.76
	12	59	2478	10853.64
	14	77	3234	14164.92
	16	-	-	-
72 W LED	8	53	3816	16714.08
	10	50	3600	15768
	12	53	3816	16714.08
	14	56	4032	17660.16
	16	77	5544	24282.72
90 W LED	8	50	4500	19710
	10	48	4320	18921.6
	12	48	4320	18921.6
	14	50	4500	19710
	16	62	5580	24440.4
120W LED	8	50	6000	26280
	10	48	5760	25228.8
	12	45	5400	23652
	14	48	5760	25228.8
	16	53	6360	27856.8
150W	8	50	7500	32850

LED	10	45	6750	29565
	12	43	6450	28251
	14	45	6750	29565
	16	50	7500	32850
250W LED	8	48	12000	52560
	10	43	10750	47085
	12	42	10500	45990
	14	40	10000	43800
	16	43	10750	47085
300W LED	8	48	14400	63072
	10	43	12900	56502
	12	42	12600	55188
	14	40	12000	52560
	16	42	12600	55188

*design parameters not satisfying minimum lighting standards

6.4 Design Based on Optimal Cost Considerations

Using developed cost programme, total annual cost was computed for all the types of lighting systems, given in Table 6.7. Table 2.4 and Table 2.5 of Chapter 2, Table 6.8(a), Table 6.8(b) and Table 6.8(c) gives the input cost parameters for the programme. Figures 6.6(a), 6.6(b), 6.6(c) and 6.6(d) shows a representative output of the cost programme for 70W HPSV lamp. The detailed output of the programme is given in the Annexure-III. The total annual cost for all the types of lighting systems under consideration is given in the Table 6.10.

Table-6.8(a): Input cost parameters of pole, cable and luminaire (source: KPWDSR)

Particulars	Cost (₹)
Cost of each pole	6000
Unit pole installation cost	500
Salvage value of luminaire	0
Salvage value of pole	0
Salvage value of cable	5%

Contd.

Cable laying cost /m	17-25
Kilowatt-hour price	7.5
Maintenance cost per luminaire	50
Unit pole fitting cost	150
Rate of interest	10%

Table-6.8(b): Input parameters w.r.t. pole and cable (*source: Lyons, 1981*)

Life of pole in years	60
Life of cable in years	40
Rate of interest on luminaire, pole and cable	10%

Table-6.8(c): Input cost parameters of cable for different rating (*source: Lyons, 1981; KAHRAMAA. 2010*)

Single phase power supply cable cost		
Cable rating (KW)	cross sectional area of the conductor (mm ²)	Cost of cable/m (₹)
1	1.5	15
3	2.5	20
5	4	30
10	6	50
15	10	100
20	16	150

Table-6.9(a): Output of the cost programme for 70W HPSV source

 Figure 1

File Edit View Insert Tools Desktop Window Help

WATTAGE OF LAMP	70
SALVAGE VALUE OF LUMINARIES IN Rs	0
RATE OF INTEREST IN %	10
LIFE OF LUMINAIRE IN YEARS	5.5000
INITIAL COST OF LUMINARIES IN Rs	197425
NUMBER OF LUMINAIRES	53
PRICE OF EACH LUMINAIRE IN Rs	3725
SALVAGE VALUE OF POLE IN RS	0
LIFE OF POLE IN YEARS	60
INITIAL COST OF POLES	360400
UNIT POLE COST IN Rs	6000
UNIT POLE INSTALLATION COST IN Rs	500
UNIT POLE FITTINGS COST IN Rs	150
UNIT POLE FITTINGS INSTALLATION C...	150
TOTAL NUMBER OF POLES	53
SALVAGE VALUE OF CABLE IN Rs	1500
LIFE OF CABLE IN YEARS	40
INITIAL CABLING COST IN Rs	50001
CABLE COST IN RUPESS/Km	30000
TOTAL LENGTH OF CABLE IN Km	1
CABLE LAYING COST IN Rs/Km	20000
UNIT PRICE OF LAMP IN RS	3725
NUMBER OF LAMPS	1
ENTER THE NUMBER OF LAMPS IN A P...	53
AVERAGE LAMP LIFE IN HOURS OF A ...	24000
BURNING HOURS PER YEAR OF THE S...	4380
KILLOWATT-HOUR PRICE IN Rs	7.5000
TOTAL WATTS PER LUMINAIRE OF A P...	70
BALLAST LOSS /LUMINAIRE IN WATTS	5
MAINTANANCE COST PER LUMINAIRE I...	48
ENTER THE LABOUR COST PER LAMP ...	50
NUBER OF CLEANINGS PER ANNUM	4

Table-6.9(b): Output of the cost programme for 70W HPSV source

NUBER OF CLEANINGS PER ANNUM	4
ANNUAL DEPRICIATION ON LUMINAIRES	2.8649e+04
ANNUAL INTEREST ON LUMINAIRES	1.9743e+04
ANNUAL DEPRICIATION ON POLES	118.7551
ANNUAL INTERESTS ON POLES	36040
ANNUAL DEPRICIATION ON CABLE	109.5839
ANNUAL INTERESTS ON CABLE	5.0001e+03
LAMP REPLACEMENT COST PER YEAR	3.6030e+04
ENERGY COST PER YEAR	1.3058e+05
ANNUAL MAINTANACE COST PER YE...	10176
ANNUAL RUNNING COST PER YEAR	1.6709e+05
FIXED ANNUAL COST	8.9660e+04
TOTAL ANNUAL COST	2.6693e+05



Table-6.10: Total annual cost for different types of sources

Type of source	Height of the pole (m)	No. of Poles	Life of the source (burning hrs)	cost of the source (₹)	Total Annual Cost (₹)
100W CFL	8	59	20000	700	2,79,250
	10	59			2,79,250
	12	71			3,83,000
	14	-			-
2x40W FTL	8	56	20000	1850	2,74,279
	10	59			2,88,700
	12	67			3,27,150
	14	-			-
80W HPMV	8	63	24000	3475	3,32,325
	10	67			3,54,975
	12	100			5,23,305
	14	-			-
125W HPMV	8	56	24000	3575	3,85,975
	10	59			3,90,655
	12	71			4,87,445
	14	-			-
150W HPMV	8	56	24000	4290	4,53,685
	10	56			4,53,685
	12	63			5,09,505
	14	77			6,26,240
	16	-			-
250W HPMV	8	53	24000	6325	6,55,095
	10	50			6,18,700
	12	53			6,55,095
	14	63			7,76,350
	16	100			12,25,106
70W MH	8	59	15000	4175	3,61,350
	10	63			3,85,505

Contd.

	12	77			4,70,010
	14	-			-
150W MH	8	53	15000	6300	5,47,755
	10	53			5,47,755
	12	56			5,68,055
	14	67			6,95,650
	16	-			-
250W MH	8	50	15000	6550	7,10,995
	10	48			6,83,045
	12	50			7,10,990
	14	53			7,52,915
	16	63			8,92,620
70W HPSV	8	53	24000	3725	2,66,930
	10	53			2,66,930
	12	59			2,96,565
	14	71			3,55,840
	16	-			-
100W HPSV	8	53	24000	4010	3,29,405
	10	50			3,07,475
	12	56			3,47,600
	14	63			3,13,625
	16	-			-
150W HPSV	8	50	24000	5100	4,23,165
	10	48			4,06,520
	12	48			4,06,520
	14	50			4,23,165
	16	59			4,98,040
250W HPSV	8	48	24000	5800	5,99,445
	10	45			5,62,740
	12	43			5,38,275
	14	45			5,62,740
	16	48			5,99,445
400W	8	48	24000	7275	9,03,390

Contd.

HPSV	10	43			8,11,155
	12	42			7,92,700
	14	40			7,55,805
	16	42			7,92,700
24 W LED	8	59	100000	3575	1,41,515
	10	62			1,50,985
	12	77			1,64,770
	14	-			-
42 W LED	8	56	100000	11350	2,39,405
	10	56			2,39,405
	12	59			2,52,010
	14	77			3,28,675
	16	-			-
72 W LED	8	53	100000	15720	3,21,490
	10	50			3,03,585
	12	53			3,21,490
	14	56			3,39,405
	16	77			4,66,800
90 W LED	8	50	100000	18985	3,63,965
	10	48			3,49,605
	12	48			3,49,605
	14	50			3,63,965
	16	62			4,50,080
120W LED	8	50	100000	21647	4,37,375
	10	48			4,20,175
	12	45			3,96,150
	14	48			4,20,175
	16	53			4,65,315
150W LED	8	50	100000	25300	6,30,145
	10	45			4,70,645
	12	43			4,50,045
	14	45			4,70,645
	16	50			6,30,140

250W LED	8	48	100000	35515	7,43,775
	10	43			6,67,040
	12	42			7,43,095
	14	40			6,21,005
	16	43			6,67,045
300W LED	8	48	100000	37610	8,46,220
	10	43			7,58,825
	12	42			7,41,340
	14	40			7,06,385
	16	42			7,41,340

Contd.

Note: CFL - Compact Fluorescent Lamp
 HPMV - High Pressure Mercury Vapour
 HPSV - High Pressure Sodium Vapour

FTL - Fluorescent Tube Lamp
 MH- Metal Halide
 LED - Light Emitting Diode

CHAPTER 7

DESIGN OF MINE LIGHTING – CASE STUDY

As a case study three large mechanized surface mines were considered for the design of lighting system— one limestone mine and two coal mines. These mines are situated in the state of Andhra Pradesh, India. Here afterwards the limestone mine is referred as ‘Mine-A’ and coal mines are referred as ‘Mine-B’ and ‘Mine-C’ respectively. Limestone mine is working with combination of shovels, surface miner and small trucks. In this mine around 1.9km length of haul road is illuminated using 2x40W FTL lamps. Coalmine is carried out using combination of shovels and dumpers. The total length of haul roads illuminated is around 3.6km and 2.7km, respectively in Mine-B and Mine-C.

Using developed cost model, total annual cost of existing lighting systems (part of the lighting systems is considered) is calculated for the three mines, i.e. Mine-A, Mine-B and Mine-C. Redesign of these lighting systems is done based on the optimum design parameters obtained, as explained in Chapter 6. To study the influence of type and wattage of source on design of lighting systems, existing system is redesigned with different types of light sources. The types of sources are selected based on optimum energy consumption (Table 6.7) and total annual cost (Table 6.10), as obtained in Chapter 6.

7.1 Design of Lighting for Mine-A

In this mine 2x40W FTL lamps were used for illuminating haul roads. The heights of poles were 8m, placed 2m beyond the kerb of the roadway. The lamps were mounted on light arms of 2m length having 30° tilt angle. The width of the roadway was 12m. The intervals between the poles were ranging from 19m to 21m. The measured horizontal illuminance levels along this roadway show that in some of the patches the illuminance level is below 0.5lux (minimum required illuminance level as per DGMS). It may be due to large intervals between poles and improper orientation of lamps, in some of the locations. Also, because of this, in many stretches of roadway the uniformity ratio is below 0.3 (minimum uniformity ratio required as per CIE and BIS standards). For redesign of lighting system a stretch of haul road of 860m length is selected. Figure 7.1 shows the existing lighting system along the

length of roadway. There were total 43 poles of 8m height. Using developed cost model total annual cost for the existing lighting system is computed. Table 7.1 gives the input parameters for the programme. Table 7.2 shows the output of the computer programme for the respective lighting system shown in Figure 7.1. The total annual cost for the existing lighting system is ₹ 59,574. The existing lighting system (i.e. with 2x40W FTL) is redesigned by adopting optimum lighting design parameters and by doing this the number of poles increased to 48.

Table 7.1: Input parameters for the programme for Mine-A

PARAMETER	VALUE
WATTAGE OF LAMP	80
SALVAGE VALUE OF LUMINARIES IN Rs	0
RATE OF INTEREST IN %	10
LIFE OF LUMINARE IN YEARS	4.5000
INITIAL COST OF LUMINARIES IN Rs	79550
NUMBER OF LUMINARE	43
PRICE OF EACH LUMINARE IN Rs	1850
SALVAGE VALUE OF POLE IN RS	0
LIFE OF POLE IN YEARS	60
INITIAL COST OF POLES	292400
UNIT POLE COST IN Rs	6000
UNIT POLE INSTALLATION COST IN Rs	500
UNIT POLE FITTINGS COST IN Rs	150
UNIT POLE FITTINGS INSTALLATION COST IN RS	150
TOTAL NUMBER OF POLES	43
SALVAGE VALUE OF CABLE IN Rs	860
LIFE OF CABLE IN YEARS	40
INITIAL CABLING COST IN Rs	3.7201e+04
CABLE COST IN RUPESS/Km	20000
TOTAL LENGTH OF CABLE IN Km	0.8600
CABLE LAYING COST IN Rs/Km	20000
UNIT PRICE OF LAMP IN RS	925
NUMBER OF LAMPS	2
ENTER THE NUMBER OF LAMPS IN A PARTICULAR TYPE	43
AVERAGE LAMP LIFE IN HOURS OF A PARTICULAR TYPE	20000
BURNING HOURS PER YEAR OF THE SWITCHING MODE	4380
KILLOWATT-HOUR PRICE IN Rs	7.5000
TOTAL WATTS PER LUMINAIRE OF A PARTICULAR TYPE	80
BALLAST LOSS /LUMINARIES IN WATTS	12
MAINTANANCE COST PER LUMINAIRE IN Rs	50
ENTER THE LABOUR COST PER LAMP REPLACEMENT	12
NUBER OF CLEANINGS PER ANNUM	4

Figure 7.2 shows the proposed lighting system with 2x40W FTL lamps mounted at 8 m height poles. Similarly, the lighting system is also designed for another five types of light sources, such as 100W HPSV, 70W HPSV, 80W HPMV, 70W MH and 24W LED. These sources are selected based on the computations made for the optimum energy consumption and optimum cost considerations (as given in Table 6.7 and Table 6.10).

For redesign of lighting system, the tilt angle is taken as 14° with 0m light arm length (i.e. source is directly mounted on the pole). The pole height is selected based on their optimum height as obtained in Table 6.10 and pole interval is based on the results as obtained in Section 6.2.

Table 7.2: Output of the cost programme for Mine-A

NUMBER OF CLEANINGS PER ANNUM	4
ANNUAL DEPRICIATION ON LUMINARIES	1.4854e+04
ANNUAL INTEREST ON LUMINARIES	7955
ANNUAL DEPRICIATION ON POLES	96.3485
ANNUAL INTERESTS ON POLES	29240
ANNUAL DEPRICIATION ON CABLE	82.1091
ANNUAL INTERESTS ON CABLE	3.7201e+03
LAMP REPLACEMENT COST PER YEAR	1.7421e+04
ENERGY COST PER YEAR	1.2995e+05
ANNUAL MAINTANACE COST PER YEAR	8600
ANNUAL RUNNING COST PER YEAR	1.4760e+05
FIXED ANNUAL COST	5.5947e+04
TOTAL ANNUAL COST	2.1215e+05

In mines, generally lamps were burning from 6 pm to 6 am i.e. for 12hr. But some of the mines are operated only up to 10 pm. By keeping this in mind, the design is also made for LED source with micro controller based photosensor, which is placed on the body of the lamp. When a natural day light reduces to an illuminance level of 60lux in the evening, the LED light automatically turn-on at rated voltage and it continues to glow at this voltage up to 12 mid night. From 12 midnight onwards till 6 am the LED source consumes only 50% of the rated voltage and the lux levels will be 50% of the rated lux. The LED light source will turn-off when the natural day light increases to a level of 68-70lux in early morning hours. Table 7.3(b) also gives the total annual cost for lighting system designed with LED sources operating at 50% rated voltage.

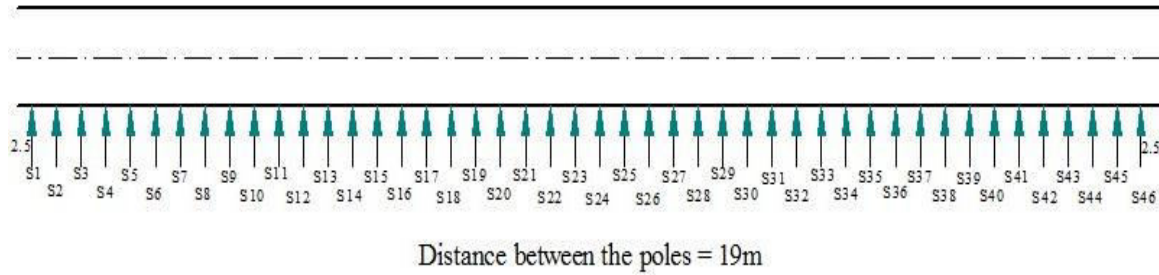

Fig.7.4 Proposed lighting system with 70W HPSV lamps (8m pole height and 19m pole interval)for Mine-A

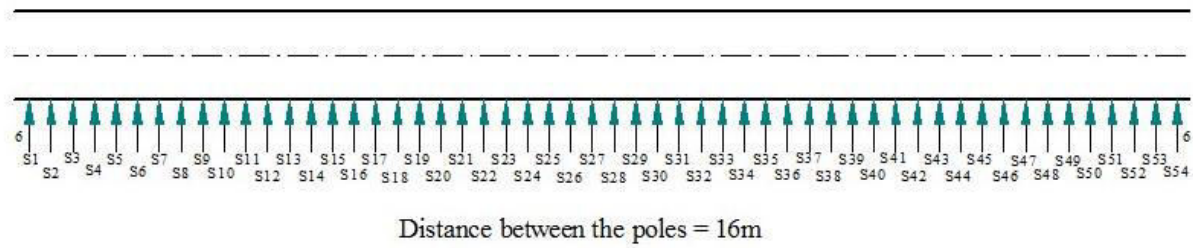

Fig.7.5 Proposed lighting system with 80W HPMV lamps (8m pole height and 16m pole interval) for Mine-A

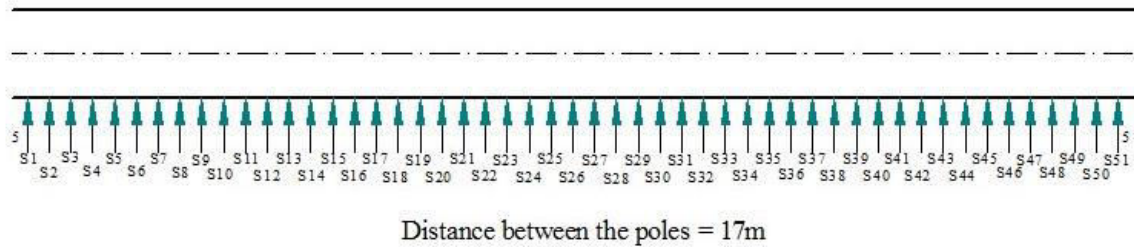

Fig. 7.6 Proposed lighting system with 70W MH lamps (8m pole height and 17m pole interval) for Mine-A

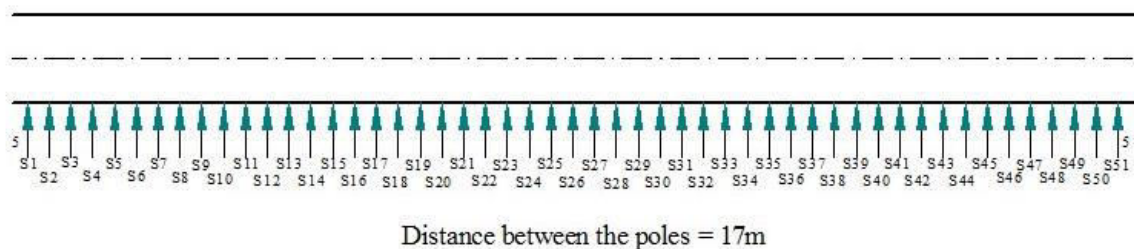

Fig. 7.7 Proposed lighting system with 24W LED lamps (8m pole height and 17m pole interval) for Mine-A

Table -7.3(a): Design parameters of existing and proposed illumination systems for Mine-A

Sl. No.	Illumination system	Type of source	Mounting height (m)	Poles interval (m)	No. of poles	E _{min} (lux)	U _o
1	Existing	2x40 FTL	8	ranging from 19 to 21	43	ranging from 0.45 to 0.22	ranging from 0.26 to 0.15
2	Proposed	2x40 FTL	10	18	48	0.5	0.3
3	Proposed	100W HPSV	10	20	45	0.5	0.3
4	Proposed	70W HPSV	8	19	45	0.5	0.3
5	Proposed	80W HPMV	8	16	54	0.5	0.3
6	Proposed	70W MH	8	17	51	0.5	0.3
7	Proposed	24W LED	8	17	51	0.5	0.3
8	Proposed*	24W LED	8	17	51	0.5	0.3

Note: FTL - Fluorescent Tube Lamp
MH- Metal Halide
LED - Light Emitting Diode

HPMV - High Pressure Mercury Vapour
HPSV - High Pressure Sodium Vapour

Table -7.3(b) Annual cost of existing and proposed illumination system for Mine-A

Sl. No.	Illumination system	Type of source	Energy consumption (KWhr)	FAC (₹)	ARC (₹)	AMC (₹)	TAC (₹)
1	Existing	2x40 FTL	15067.20	55,947	147602	8600	2,12,149
2	Proposed	2x40 FTL	16819.00	62010	164832	9600	2,36,442
3	Proposed	100W HPSV	19710.00	76,200	1,95,587	9,000	2,80,787

Contd.

4	Proposed	70W HPSV	13797.00	75,590	1,41,507	9,000	2,26,097
5	Proposed	80W HPMV	18921.60	87,515	1,85,080	10,800	2,83,395
6	Proposed	70W MH	15636.60	1,13,660	1,87,876	10,200	3,11,736
7	Proposed	24W LED	5361.12	59,121	53,270	10,200	1,22,591
8	Proposed*	24W LED*	5361.12	59,121	43,218	10,200	1,12,539

*operating with 50% rated voltage

Note: FAC= Fixed Annual Cost

AMC= Annual Maintenance Cost

ARC- Annual Running Cost

TAC- Total Annual Cost

7.2 Design of Lighting for Mine-B

In the Mine-B, 250W MH lamps were used for illuminating haul roads. The heights of poles were 12m and are located 2m beyond the kerb of the roadway. The lamps were mounted on 2m length arms with 45° tilt angle. The average width of the roadway was 12m. The intervals between poles were ranging from 22m to 25m. Due to this irregular interval at many stretches the uniformity ratio was below 0.3 (minimum uniformity ratio required as per CIE and BIS standards). Also in many portions of roadway horizontal illuminance level was below 0.5lux (minimum required illuminance level as per DGMS).

For design of lighting system, a stretch of haul road of 420m length is considered. Figure 7.8 shows the arrangement of existing lighting system along the length of roadway. There were total 18 poles of 12m height. Using developed cost model, total annual cost for this existing lighting system is computed. Table 7.4 gives the input parameters for the programme.

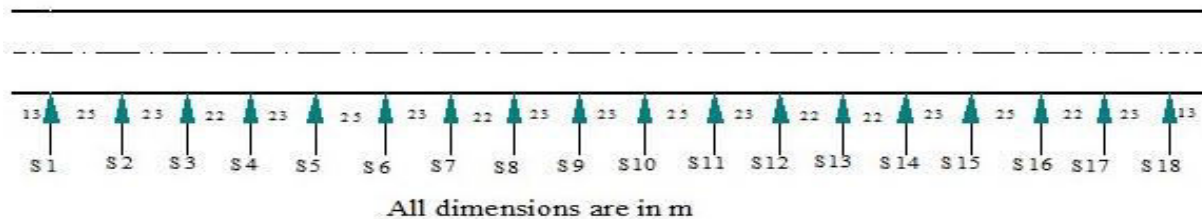

Fig. 7.8 Existing lighting system with 250W MH sources (12m pole height and irregular pole interval) in Mine-B

Table- 7.4: Input parameters for the programme for Mine-B

PARAMETER	VALUE
WATTAGE OF LAMP	250
SALVAGE VALUE OF LUMINARIES IN Rs	0
RATE OF INTEREST IN %	10
LIFE OF LUMINARE IN YEARS	3.5000
INITIAL COST OF LUMINARIES IN Rs	117900
NUMBER OF LUMINARE	18
PRICE OF EACH LUMINARE IN Rs	6550
SALVAGE VALUE OF POLE IN RS	0
LIFE OF POLE IN YEARS	60
INITIAL COST OF POLE	122400
UNIT POLE COST IN Rs	6000
UNIT POLE INSTALLATION COST IN Rs	500
UNIT POLE FITTINGS COST IN Rs	150
UNIT POLE FITTINGS INSTALLATION C...	150
TOTAL NUMBER OF POLES	18
SALVAGE VALUES OF CABLES IN Rs	645
LIFE OF CABLE IN YEARS	40
INITIAL CABLING COST IN Rs	3.2900e+04
CABLE COST IN RUPES/Km	30000
TOTAL LENGTH OF CABLE IN Km	0.4300
CABLE LAYING COST IN Rs/Km	20000
UNIT PRICE OF LAMPS IN RS	6550
NUMBER OF LAMPS	1
ENTER THE NUMBER OF LAMPS IN A P...	18
AVERAGE LAMP LIFE IN HOURS OF A ...	15000
BURNING HOURS PER YEAR OF THE S...	4380
KILLOWATT-HOUR PRICE IN Rs	7.5000
TOTAL WATTS PER LUMINAIRE OF A P...	250
BALLAST LOSS /LUMINARIES IN WAT...	20
MAINTANANCE COST PER LUMINARIE...	50
NUBER OF CLEANINGS PER ANNUM	4

Table 7.5 is the output of the computer programme for the respective lighting system shown in Figure 7.8. The total annual cost for the existing lighting system is in ₹ 2,54,903/-. The haul road which is shown in the Figure 7.9 is redesigned with five different types of light sources, such as 250W MH, 70W HPSV, 70W MH, 70W HPMV and 24W LED. Figures 7.8, 7.10, 7.11, 7.12 and 7.13 shows the layout of redesigned lighting systems, respectively for 250W MH, 70W HPSV, 70W MH, 70W HPMV and 24W LED sources. Table 7.6(a) and Table 7.6(b) give the details of lighting parameters and total annual cost, respectively for all

the redesigned systems. However, for easy reference existing design lighting parameters along with the annual cost is also indicated in these tables.

Table- 7.5: Output of the cost programme for Mine-B

NUBER OF CLEANINGS PER ANNUM	4
ANNUAL DEPRICIATION ON LUMINARIES	2.9775e+04
ANNUAL INTEREST ON LUMINARIES	11790
ANNUAL DEPRICIATION ON POLES	40.3319
ANNUAL INTERESTS ON POLES	12240
ANNUAL DEPRICIATION ON CABLES	72.8784
ANNUAL INTERESTS ON CABLES	3.2900e+03
LAMP REPLACEMENT COST PER YEAR	3.4427e+04
ENERGY COST PER YEAR	159651
ANNUAL MAINTANACE COST PER YE...	3600
ANNUAL RUNNING COST PER YEAR	1.9410e+05
FIXED ANNUAL COST	5.7209e+04
TOTAL ANNUAL COST	2.5490e+05

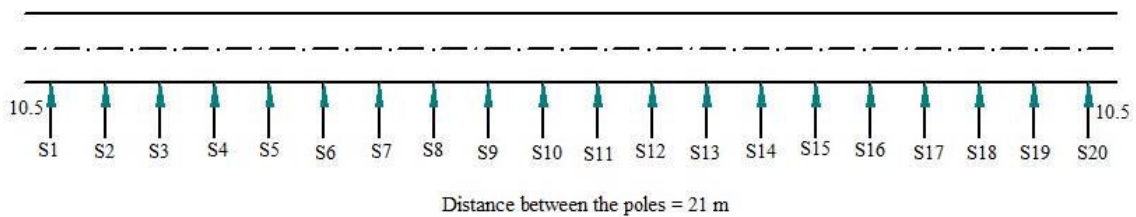

Fig. 7.9 Proposed lighting system with 250W MH lamps (10m pole height and 21m pole interval) for Mine-B

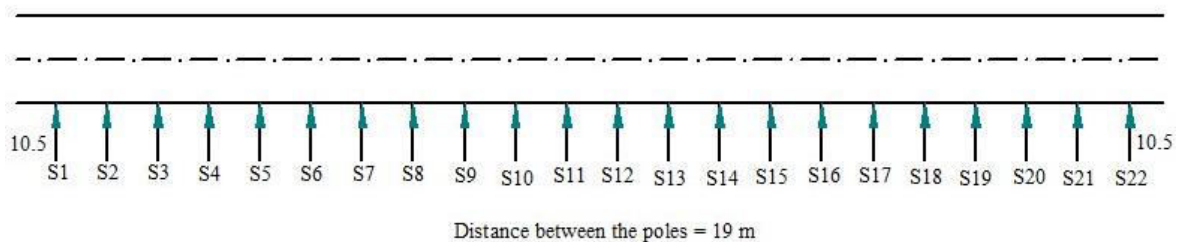

Fig.7.10 Proposed lighting system with 70W HPSV lamps (8m pole height and 19m pole interval) for Mine-B

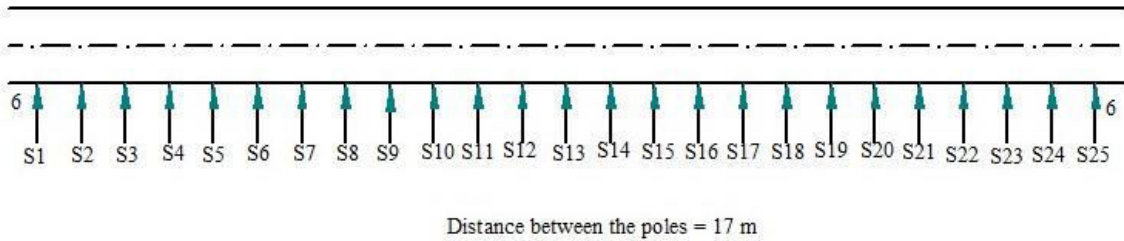

Fig. 7.11 Proposed lighting system with 70W MH lamps (8m pole height and 17m pole interval) for Mine-B

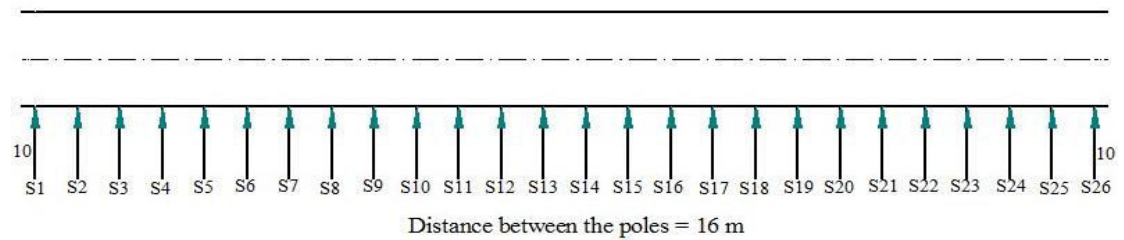

Fig. 7.12 Proposed lighting system with 80W HPMV lamps (8m pole height and 16m pole interval) for Mine-B

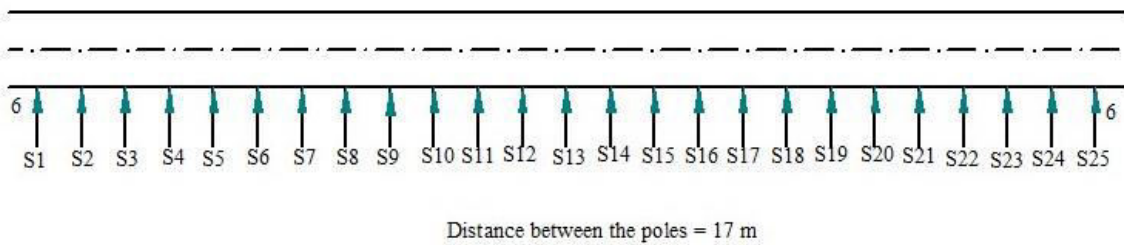

Fig. 7.13 Proposed lighting system with 24W LED lamps (8m pole height and 17m pole interval) for Mine-B

Table-7.6(a): Design parameters of existing and proposed illumination systems for Mine-B

Sl. No.	Illumination system	Type of source	Mounting height (m)	Interval (m)	No. of Poles	E_{\min} (lux)	U_o
1	Existing	250W MH	12	ranging from 22 to 25	18	ranging from 0.43 to 0.25	ranging from 0.24 to 0.13
2	Proposed	250W MH	10	21	20	0.5	0.3
3	Proposed	70W HPSV	8	19	22	0.5	0.3

Contd.

4	Proposed	70W MH	8	17	25	0.5	0.3
5	Proposed	80W HPMV	8	16	26	0.5	0.3
6	Proposed	24W LED	8	17	25	0.5	0.3
7	Proposed*	24W LED	8	17	25	0.5	0.3

Note: FTL - Fluorescent Tube Lamp
MH- Metal Halide
LED - Light Emitting Diode

HPMV - High Pressure Mercury Vapour
HPSV - High Pressure Sodium Vapour

Table-7.6(b): Annual cost of existing and proposed illumination systems for Mine-B

Sl. No.	Illumination system	Type of source	Energy consumption (KWhr)	FAC (₹)	ARC (₹)	AMC (₹)	TAC (₹)
1	Existing	250W MH	20805.00	57,207	1,94,096	3,600	2,54,903
2	Proposed	250W MH	21900.00	63,188	2,15,662	4,000	2,82,850
3	Proposed	70W HPSV	6132.00	33,232	3,728	3,800	1,04,539
4	Proposed	70W MH	7665.00	56,756	92,097	5,000	1,53,853
5	Proposed	80W HPMV	9110.40	42,787	87,399	5,200	1,35,386
6	Proposed	24W LED	2628.00	29,821	26,113	5,000	60,934
7	Proposed*	24W LED	2628.00	29,821	21,185	5,000	56,006

*operating with 50% rated voltage

Note: FAC= Fixed Annual Cost
AMC= Annual Maintenance Cost

ARC- Annual Running Cost
TAC- Total Annual Cost

7.3 Design of Lighting for Mine-C

7.3.1 Haul road lighting

In this mine 400W HPSV lamps were used for illuminating haul roads. The heights of poles were 12m and are located 2m beyond the kerb of the roadway. The lamps were mounted on 2m arm length, which are having 30° tilt angles. The average width of the roadway was 12m. The intervals between poles were ranging from 20 to 42m. Due to this irregular interval at

many stretches the uniformity ratio was below 0.3 (minimum uniformity ratio required as per CIE and BIS standards). Also in many portions of roadway horizontal illuminance level is below 0.5lux (as per DGMS).

For design of lighting system a stretch of haul road of 578m length is considered. Figure 7.14 shows the arrangement of existing lighting system along the length of roadway. There were total 19 poles of 12m height. Using developed cost model total annual cost for this existing lighting system is computed. Table 7.7 gives the input parameters for the programme. Table 7.8 is the output of the computer programme for the respective lighting system shown in Figure 7.14. The total annual cost for the existing lighting system is ₹ 3,61,903/-. The haul road which is shown in the Figure 7.16 is redesigned with four different types of light sources, such as 400W HPSV, 70W HPSV, 70W MH, 80W HPMV, and 24W LED. Figures 7.15, 7.16, 7.17, 7.18 and 7.19 shows the layout of redesigned lighting systems, respectively with 400W HPSV, 70W HPSV, 70W MH, 80W HPMV and 24W LED sources.

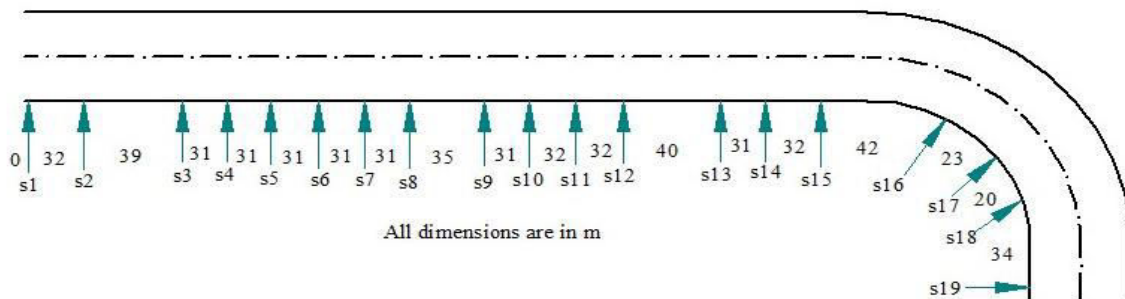

Fig. 7.14 Existing lighting system with 400W HPSV sources (12m pole height and irregular pole interval) in Mine-C

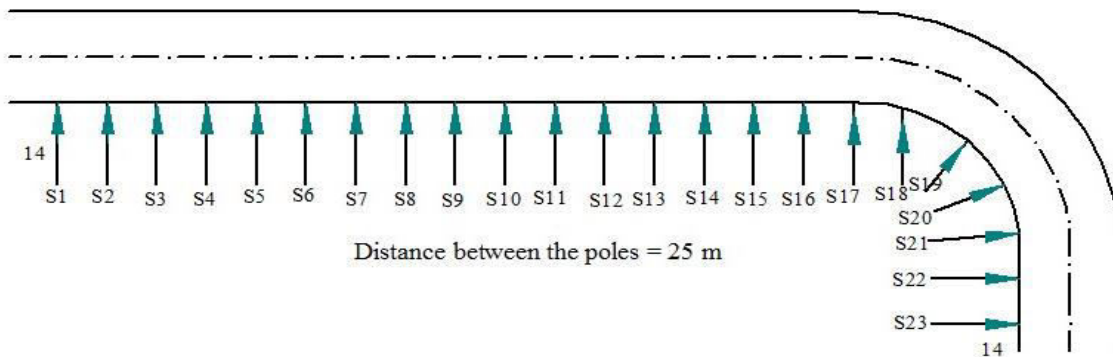

Fig. 7.15 Proposed lighting system with 400W HPSV sources (14m pole height and 25m pole interval) for Mine-C

Table-7.7: Input parameters for the programme for Mine-C

Figure 1

File Edit View Insert Tools Desktop Window Help

WATTAGE OF LAMP	400
SALVAGE VALUE OF LUMINARIES IN Rs	0
RATE OF INTEREST IN %	10
LIFE OF LUMINARE IN YEARS	5.5000
INITIAL COST OF LUMINARIES IN Rs	138168
NUMBER OF LUMINARE	19
PRICE OF EACH LUMINARE IN Rs	7272
SALVAGE VALUE OF POLE IN RS	0
LIFE OF POLE IN YEARS	60
INITIAL COST OF POLE	129200
UNIT POLE COST IN Rs	6000
UNIT POLE INSTALLATION COST IN Rs	500
UNIT POLE FITTINGS COST IN Rs	150
UNIT POLE FITTINGS INSTALLATION C...	150
TOTAL NUMBER OF POLES	19
SALVAGE VALUES OF CABLES IN Rs	4335
LIFE OF CABLE IN YEARS	40
INITIAL CABLING COST IN Rs	1.1170e+05
CABLE COST IN RUPESS/Km	150000
TOTAL LENGTH OF CABLE IN Km	0.5780
CABLE LAYING COST IN Rs/Km	25000
UNIT PRICE OF LAMPS IN RS	7272
NUMBER OF LAMPS	1
ENTER THE NUMBER OF LAMPS IN A P...	19
AVERAGE LAMP LIFE IN HOURS OF A ...	24000
BURNING HOURS PER YEAR OF THE S...	4380
KILLOWATT-HOUR PRICE IN Rs	7.5000
TOTAL WATTS PER LUMINAIRE OF A P...	400
BALLAST LOSS /LUMINARIES IN WAT...	40
MAINTANANCE COST PER LUMINARIE...	50
NUBER OF CLEANINGS PER ANNUM	4

Table-7.8: Output of the cost programme for Mine-C

NUBER OF CLEANINGS PER ANNUM	4
ANNUAL DEPRICIATION ON LUMINARIES	2.0050e+04
ANNUAL INTEREST ON LUMINARIES	1.3817e+04
ANNUAL DEPRICIATION ON POLES	42.5726
ANNUAL INTERESTS ON POLES	12920
ANNUAL DEPRICIATION ON CABLES	242.5833
ANNUAL INTERESTS ON CABLES	1.1170e+04
LAMP REPLACEMENT COST PER YEAR	2.5216e+04
ENERGY COST PER YEAR	274626
ANNUAL MAINTANACE COST PER YE...	3800
ANNUAL RUNNING COST PER YEAR	2.9986e+05
FIXED ANNUAL COST	5.8242e+04
TOTAL ANNUAL COST	3.6190e+05

Table 7.9(a) gives the details of lighting parameters and Table 7.9(b) indicates the respective total annual cost for all the redesigned systems of Mine-C. However, for easy reference existing design lighting parameters and the annual cost is also indicated in Table 7.9(a) and Table 7.9(b), respectively.

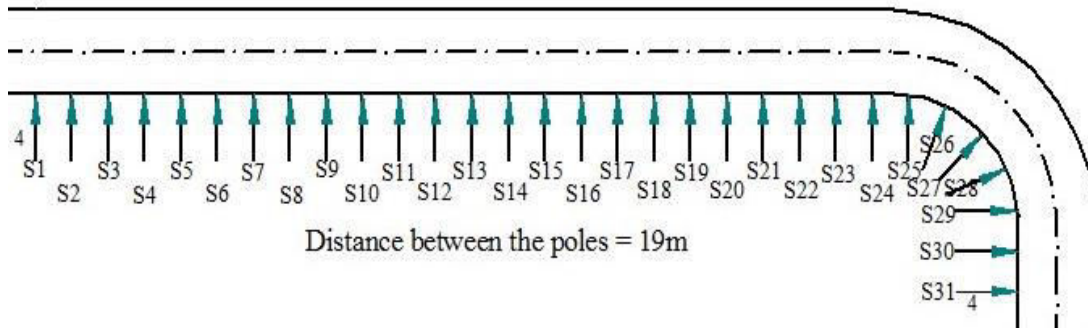

Fig. 7.16 Proposed lighting system with 70W HPSV sources (8m pole height and 19m pole interval) for Mine-C

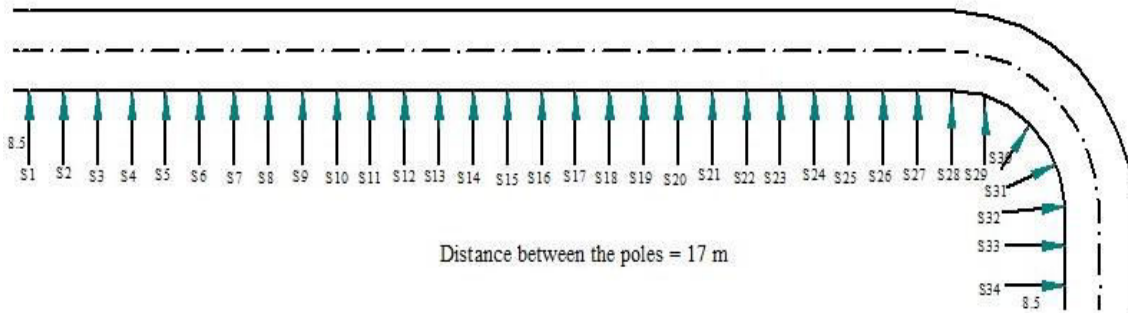

Fig. 7.17 Proposed lighting system with 70W MH sources (8m pole height and 17m pole interval) for Mine-C

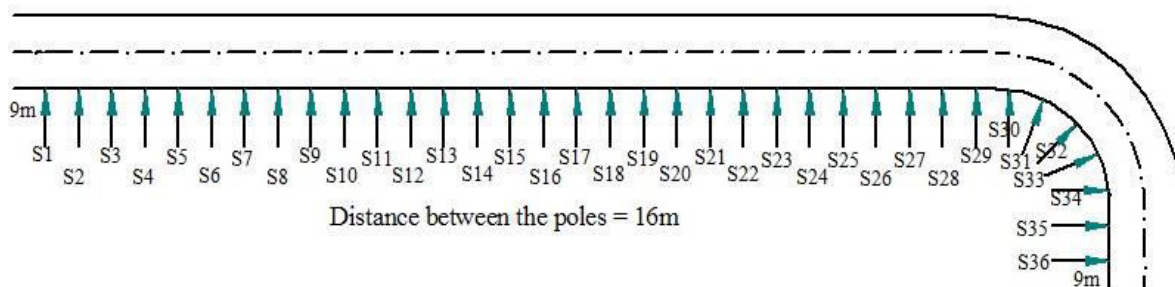

Fig. 7.18 Proposed lighting system with 80W HPMV sources (8m pole height and 16m pole interval) for Mine-C

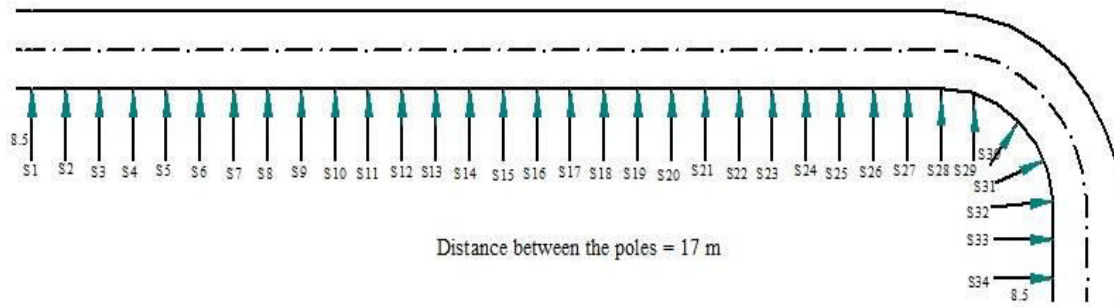

Fig. 7.19 Proposed lighting system with 24W LED sources (8m pole height and 17m pole interval) for Mine-C

Table 7.9(a): Design parameters of existing and proposed illumination systems for Mine-C

Sl. No.	Illumination system	Type of source	Mounting height (m)	Poles interval (m)	No. of Poles	E_{min} (lux)	U_o
1	Existing	400W HPSV	12	ranging from 20 to 42	19	ranging from 0.44 to 0.32	ranging from 0.23 to 0.12
2	Proposed	400W HPSV	14	25	23	0.5	0.3
3	Proposed	70W HPSV	8	19	30	0.5	0.3
4	Proposed	70W MH	8	17	34	0.5	0.3
5	Proposed	80W HPMV	8	16	36	0.5	0.3
6	Proposed	24W LED	8	17	34	0.5	0.3
7	Proposed*	24W LED	8	17	34	0.5	0.3

Note: FTL - Fluorescent Tube Lamp
 MH- Metal Halide
 LED - Light Emitting Diode

HPMV - High Pressure Mercury Vapour
 HPSV - High Pressure Sodium Vapour

Table 7.9(b): Annual cost of existing and proposed illumination system for Mine-C

Sl. No.	Illumination system	Type of source	Energy consumption (KW/hr)	FAC (₹)	ARC (₹)	AMC (₹)	TAC (₹)
1	Existing	400W HPSV	33288.00	58,242	2,99,861	3,800	3,61,903
2	Proposed	400W HPSV	40296.00	68,101	3,62,989	4,600	4,35,690
3	Proposed	70W HPSV	9198.00	51,085	94,337	6,000	1,51,422
4	Proposed	70W MH	10424.40	76,466	1,25,251	6,800	2,08,517
5	Proposed	80W HPMV	12614.40	58,450	1,21,023	7,200	1,86,673
6	Proposed	24W LED	3574.08	39,503	35,513	6,800	81,816
7	Proposed*	24W LED	3574.08	39,503	28,812	6,800	75,115

*operating with 50% rated voltage

Note: FAC= Fixed Annual Cost

AMC= Annual Maintenance Cost

ARC- Annual Running Cost

TAC- Total Annual Cost

7.3.2 Area Lighting

There are two basic approaches for area lighting which can be differentiated by the intensity distribution provided by the luminaire. In areas where high illuminance level is not required lamps mounted on poles, which are placed at regular intervals, can be used. On the other hand, floodlights mounted on towers or high mast can be used, whenever high illuminance and wide distribution of light is needed. The luminaires used in first case are mainly street lighting lanterns. The intervals of poles should not generally exceed three times the mounting height (Henderson et al., 1972). Depending on the illuminance required the highest possible wattage and mounting height usually provides the most economical solution for this type of installation.

Table 7.10 gives the details of installations of existing lighting system in areas, such as stack yard, dump yard, mine site office and crusher point. In large patches of these areas light level is below 3.0lux, i.e. the minimum illuminance level specified by DGMS. However, in area

lighting because of large coverage it is very difficult, in fact expensive to maintain 0.3 uniformity ratio. In commercial lighting wherever the uniformity ratio is to be maintained it is desirable to go for floodlighting mounted on mast or towers, with proper aiming tilt angles. But in the mines due to continuous movement of working areas it is not practical to illuminate with flood lights. In Mine-C for area lighting high wattage HPSV sources were used which are mounted on poles. For illuminating stack yard and crusher area two each 400W HPSV sources mounted on 14m poles were used. For dump yard lighting one 400W HPSV source mounted on 14m light pole is used. Near the mine site office two light poles of 10m height were installed with one 250W HPSV source on each pole, so as to illuminate the site office and workshop area. Using the cost model the total annual cost of the existing lighting system is computed. Table 7.11 shows the input parameters for the cost programme, whereas output of the programme is given in Table 7.12.

Table-7.10: Details of installations of existing Area lighting system for Mine-C

Area /place	Type of source	Pole height (m)	Tilt angle (deg)	Cable length (m)
Stack yard	400W HPSV- 2 nos.	14	30	40
Dump yard	400W HPSV- 1 no.	14	25	120
Mine site office	250W HPSV- 2 nos.	10	15	80
Crusher point	400W HPSV- 2 no.	14	35	60

In all previous case studies (i.e. for Mine-A, Mine-B and Mine-C) it is found that the total annual cost is the minimum with LED sources. Hence, for redesigning of area lighting 250W LED source is preferred, since the lower wattage LED sources (i.e. 24W, 42W, 72W, 90W and 120W) are not favoring the required lighting standards at 8m pole height (minimum height required for area lighting). Using the developed design model the lighting systems of all these four major areas are redesigned with 250W LED sources mounted at 8m height. The details of lighting installations of proposed illumination system are given in Table 7.13. The output of the design model is given in Annexure IV.

Table-7.11: Input parameters for the programme for existing area lighting system for Mine-C

PARAMETERS	VALUES
WATTAGE OF LAMP	400
SALVAGE VALUE OF LUMINARIES IN Rs	0
RATE OF INTEREST IN %	10
LIFE OF LUMINARE IN YEARS	5.5000
INITIAL COST OF LUMINARIES IN Rs	45500
NUMBER OF LUMINARE	7
PRICE OF EACH LUMINARE IN Rs	6500
SALVAGE VALUE OF POLE IN RS	0
LIFE OF POLE IN YEARS	60
INITIAL COST OF POLES	27200
UNIT POLE COST IN Rs	6000
UNIT POLE INSTALLATION COST IN Rs	500
UNIT POLE FITTINGS COST IN Rs	150
UNIT POLE FITTINGS INSTALLATION C...	150
TOTAL NUMBER OF POLES	4
SALVAGE VALUE OF CABLE IN Rs	300
LIFE OF CABLE IN YEARS	40
INITIAL CABLING COST IN Rs	2.6000e+04
CABLE COST IN RUPESS/Km	20000
TOTAL LENGTH OF CABLE IN Km	0.3000
CABLE LAYING COST IN Rs/Km	20000
UNIT PRICE OF LAMP IN RS	6500
NUMBER OF LAMPS	1
ENTER THE NUMBER OF LAMPS IN A P...	7
AVERAGE LAMP LIFE IN HOURS OF A ...	24000
BURNING HOURS PER YEAR OF THE S...	4380
KILLOWATT-HOUR PRICE IN Rs	7.5000
TOTAL WATTS PER LUMINAIRE OF A P...	400
BALLAST LOSS /LUMINARIES IN WAT...	35
MAINTANANCE COST PER LUMINAIRE I...	50
ENTER THE LABOUR COST PER LAMP ...	15
NUBER OF CLEANINGS PER ANNUM	4

Table-7.12: Ouput of the programme for existing area lighting system for Mine-C

NUBER OF CLEANINGS PER ANNUM	4
ANNUAL DEPRICIATION ON LUMINARIES	6.6027e+03
ANNUAL INTEREST ON LUMINARIES	4550
ANNUAL DEPRICIATION ON POLES	8.9627
ANNUAL INTERESTS ON POLES	2720
ANNUAL DEPRICIATION ON CABLE	58.0676
ANNUAL INTERESTS ON CABLE	2.6000e+03
LAMP REPLACEMENT COST PER YEAR	8.3038e+03
ENERGY COST PER YEAR	1.0003e+05
ANNUAL MAINTANACE COST PER YE...	1400
ANNUAL RUNNING COST PER YEAR	1.0835e+05
FIXED ANNUAL COST	1.6540e+04
TOTAL ANNUAL COST	1.2629e+05

Table-7.13: Details of installations of proposed Area lighting systems for Mine-C

Area /place	Type of source	Pole height (m)	Tilt angle (deg)	Cable length (m)
Stack yard	250W LED – 2 nos.	8	14	40
Dump yard	250W LED – 1 no.	8	14	120
Mine site office	250W LED – 2 nos.	8	14	80
Crusher point	250W LED – 2 nos.	8	14	60

Using the cost model, total annual cost of the proposed lighting system is calculated. Table 7.14 indicates the input parameters for the programme. The output of the cost programme is given in Table 7.15.

Table-7.16 gives the annual energy consumption and total annual cost of the existing and proposed lighting systems for entire area lighting under consideration. The total annual cost of the existing lighting system is ₹ 1,26,290/- , whereas that of proposed system in ₹ 1,43,400/-.

Table-7.14: Input parameters for the programme for proposed area lighting system for Mine-C

PARAMETER	VALUE
WATTAGE OF LAMP	250
SALVAGE VALUE OF LUMINARIES IN Rs	0
RATE OF INTEREST IN %	10
LIFE OF LUMINARE IN YEARS	23
INITIAL COST OF LUMINARIES IN Rs	248605
NUMBER OF LUMINARE	7
PRICE OF EACH LUMINARE IN Rs	35515
SALVAGE VALUE OF POLE IN RS	0
LIFE OF POLE IN YEARS	60
INITIAL COST OF POLES	27200
UNIT POLE COST IN Rs	6000
UNIT POLE INSTALLATION COST IN Rs	500
UNIT POLE FITTINGS COST IN Rs	150
UNIT POLE FITTINGS INSTALLATION C...	150
TOTAL NUMBER OF POLES	4
SALVAGE VALUE OF CABLE IN Rs	300
LIFE OF CABLE IN YEARS	40
INITIAL CABLING COST IN Rs	2.6000e+04
CABLE COST IN RUPESS/Km	20000
TOTAL LENGTH OF CABLE IN Km	0.3000
CABLE LAYING COST IN Rs/Km	20000
UNIT PRICE OF LAMP IN RS	35515
NUMBER OF LAMPS	1
ENTER THE NUMBER OF LAMPS IN A P...	7
AVERAGE LAMP LIFE IN HOURS OF A ...	24000
BURNING HOURS PER YEAR OF THE S...	4380
KILLOWATT-HOUR PRICE IN Rs	7.5000
TOTAL WATTS PER LUMINAIRE OF A P...	250
BALLAST LOSS /LUMINARIES IN WAT ...	25
MAINTANANCE COST PER LUMINAIRE I...	50
ENTER THE LABOUR COST PER LAMP ...	15
NUBER OF CLEANINGS PER ANNUM	4

Table-7.15: Ouput of the programme for proposed area lighting system for Mine-C

NUBER OF CLEANINGS PER ANNUM	4
ANNUAL DEPRICIATION ON LUMINARIES	3.1254e+03
ANNUAL INTEREST ON LUMINARIES	2.4861e+04
ANNUAL DEPRICIATION ON POLES	8.9627
ANNUAL INTERESTS ON POLES	2720
ANNUAL DEPRICIATION ON CABLE	58.0676
ANNUAL INTERESTS ON CABLE	2.6000e+03
LAMP REPLACEMENT COST PER YEAR	4.5370e+04
ENERGY COST PER YEAR	6.3236e+04
ANNUAL MAINTANACE COST PER YE...	1400
ANNUAL RUNNING COST PER YEAR	1.0863e+05
FIXED ANNUAL COST	3.3373e+04
TOTAL ANNUAL COST	1.4340e+05

Table-7.16: Total annual cost of existing and proposed Area lighting systems for Mine-C

Lighting system	Energy consumption per year (KW-hr)	Total annual cost (₹)
Existing	10950	1,26,290
Proposed	7665	1,43,400

CHAPTER – 8

RESULTS AND OVERALL DISCUSSION

As discussed in earlier chapters, the performance of a lighting system is mainly depends upon its design parameters and under which circumstances it is used. Hence, while designing lighting system one has to take care of design parameters, such as tilt angle, light arm length, mounting height, source interval etc. Further, selection of luminaire for particular type of work place is also very essential. For example, in mines having problem of dense fog HPSV lamps gives better performance compared to any other type of sources.

8.1 Optimization of Design Parameters

To study the effect of design parameters on performance of the light sources, a roadway of 9m width is considered and the grids (of 1m x 1m size) are prepared across the width and length of the roadway, using developed computer model. The illuminance levels are computed at the centre of the roadway along the axis of the pole for 150W HPSV source. The pole height is varied in steps from 8m to 12m at 1m interval, and the design is made for different combination of light arm length (i.e. 0m, 1m, and 2m) and tilt angle (which is varied from 0° to 30°).

This study reveals that whenever the light poles are installed beyond the kerb of the roadway, which generally exists in the surface mines, the lighting will be very effective with 14° tilt angle and 0m arm length. This result also corroborates with the literature review (Bommel et al., 1980). The mounting height of the source is mainly depends upon the width of the roadway as well as on intensity of the source. Hence, the height of the pole varies with the type of source.

The intervals between the poles is also depends upon the height of the pole, in turn on the intensity of the source. For optimization of pole intervals, a haul road of 12m width is considered and horizontal lux levels are computed in between two poles, so as to obtain minimum of 0.5lux with 0.3 uniformity ratio. This is done for six types of luminaries of different wattages, at different heights, as discussed in Section 6.2. The tilt angle is kept at

14° with 0m light arm length. Table 6.6 gives the optimum pole intervals for different types of sources mounted at 8m, 10m, 12m, 14m and 16m. For some sources, especially in case of low wattage sources, it is not able to achieve the minimum lighting standards, at greater pole heights. For example, the maximum mounting height for 80W HPMV would be 12m. But in case of 150W HPMV sources, the minimum lighting standards could be achieved even at 14m mounting height. However, by increasing the pole height up to 16m, the wattage of the lamp is required to be increased. As given in Table 6.6, 250W HPMV sources mounted on 16m height poles, at 10m interval, fulfils the minimum required lighting standards. A close look at the Table 6.6 reveals that the interval between the poles increases with the increase in intensity of the sources. Further, the mounting height is also favours the pole intervals, as depicted in Table 8.1, which shows the relative increase in pole intervals with increase in wattage of the sources and pole height.

Table 8.1 Relative increase in pole intervals w.r.t increase in pole height and the wattage of the source (as obtained from Table 6.6)

Pole height (in m)	Pole interval		Relative increase in pole interval (m)	Pole interval		Relative increase in pole interval (m)
	For 80W HPMV	For 250W HPMV		For 70W HPSV	For 400W HPSV	
8	16m	19m	3	19m	21m	2
10	15m	20m	5	19m	23m	4
12	10m	19m	9	17m	24m	7
14	*	16m	-	14m	25m	9
16	*	10m	-	*	24m	-

Note: HPMV - High Pressure Mercury Vapour
HPSV - High Pressure Sodium Vapour

8.2 Design Based on Optimal Energy Considerations

Energy cost is one of the major cost components of the lighting system. As discussed in the literature review, uniform distribution of light will be achieved with more number of low wattage sources. But when there is huge variety of lamps (i.e. type of source as well as its wattage) are available in the market the selection of particular type of lamp is also very important, so as to optimize the energy consumption. Meanwhile the selection of lamp should also satisfy the minimum required lighting standards. Table 6.7 (in section 6.3) gives the annual energy consumption for different types of sources for illuminating 1 km stretch of haul road. Using the data from Table 6.7, a bar chart is plotted with annual energy

consumption (i.e. minimum energy consumption among five pole heights is considered) along Y-axis and type of sources along X-axis which is shown in Figure 8.1.

As shown in the Figure 8.1, among all the sources under consideration, the energy consumption for 24W LED source is the minimum (i.e. 6202KW-hr), whereas the consumption is maximum for 400W HPSV sources (70080KW-hr). For seven types of sources (i.e. 42W LED, 70W HPSV, 90W LED, 100W CFL, 150W HPSV, 150W MH and 150W HPMV) the energy consumption is found minimum for more than one mounting heights. This is because of the same pole intervals for two different pole heights.

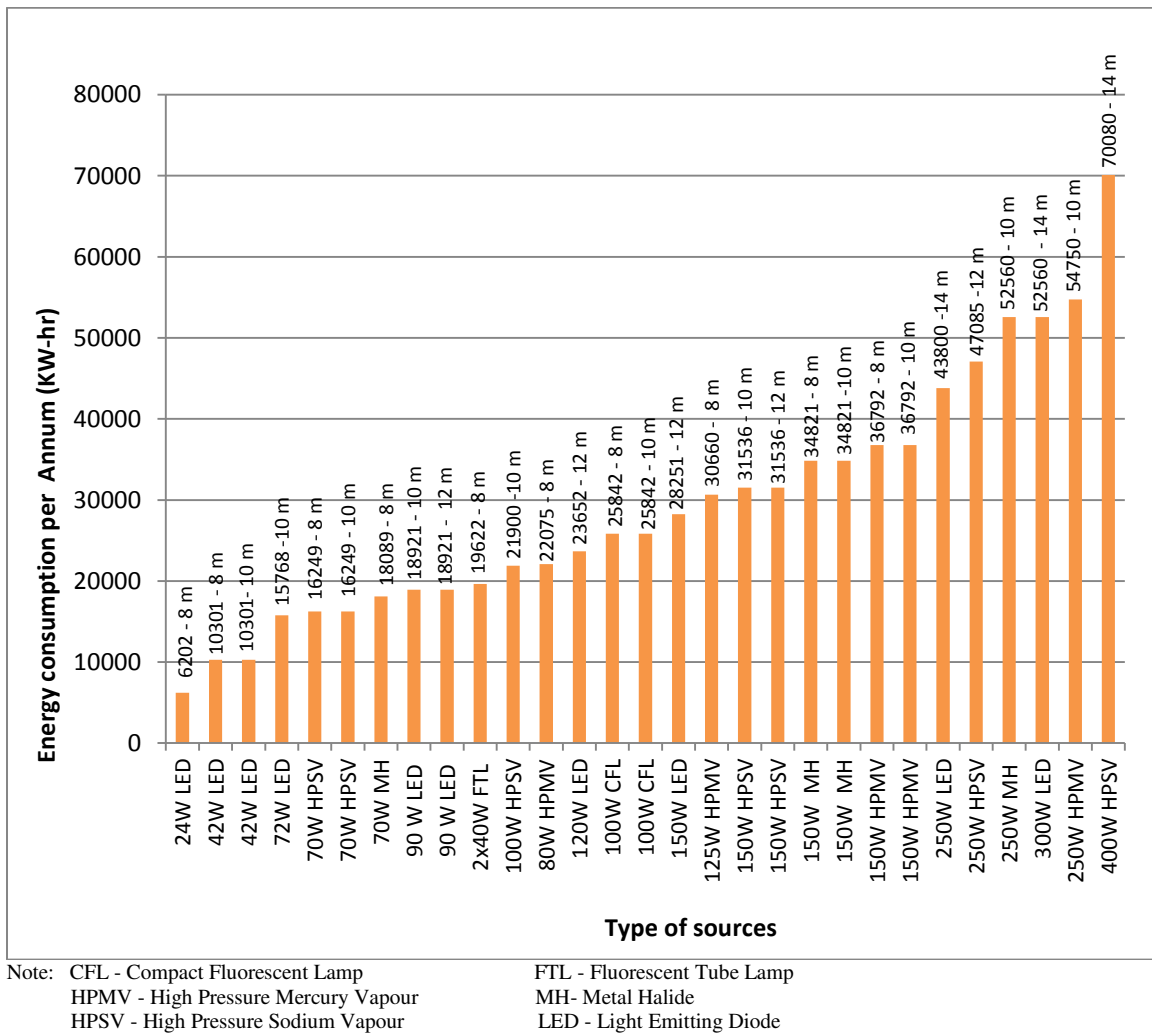

Fig. 8.1 Bar chart showing annual energy consumption for different types of lighting systems

8.3 Design Based on Optimal Cost Considerations

As discussed in Section 8.2, the energy consumption may be the same for some of the lighting systems, even though the type of lamps used are different. Under such circumstances one has to take decision based on the total annual cost of the lighting system for optimizing the cost of the entire lighting project. In this regard, the total annual cost is calculated for all the lighting systems, given in Table 6.7(in section 6.3). Table 6.10 (in section 6.3) gives the total annual cost for different types of sources for illuminating 1km stretch of haul road. A bar chart is plotted with total annual cost (i.e. minimum annual cost among five pole heights is considered) along Y-axis and type of sources along X-axis which is shown in Figure 8.2.

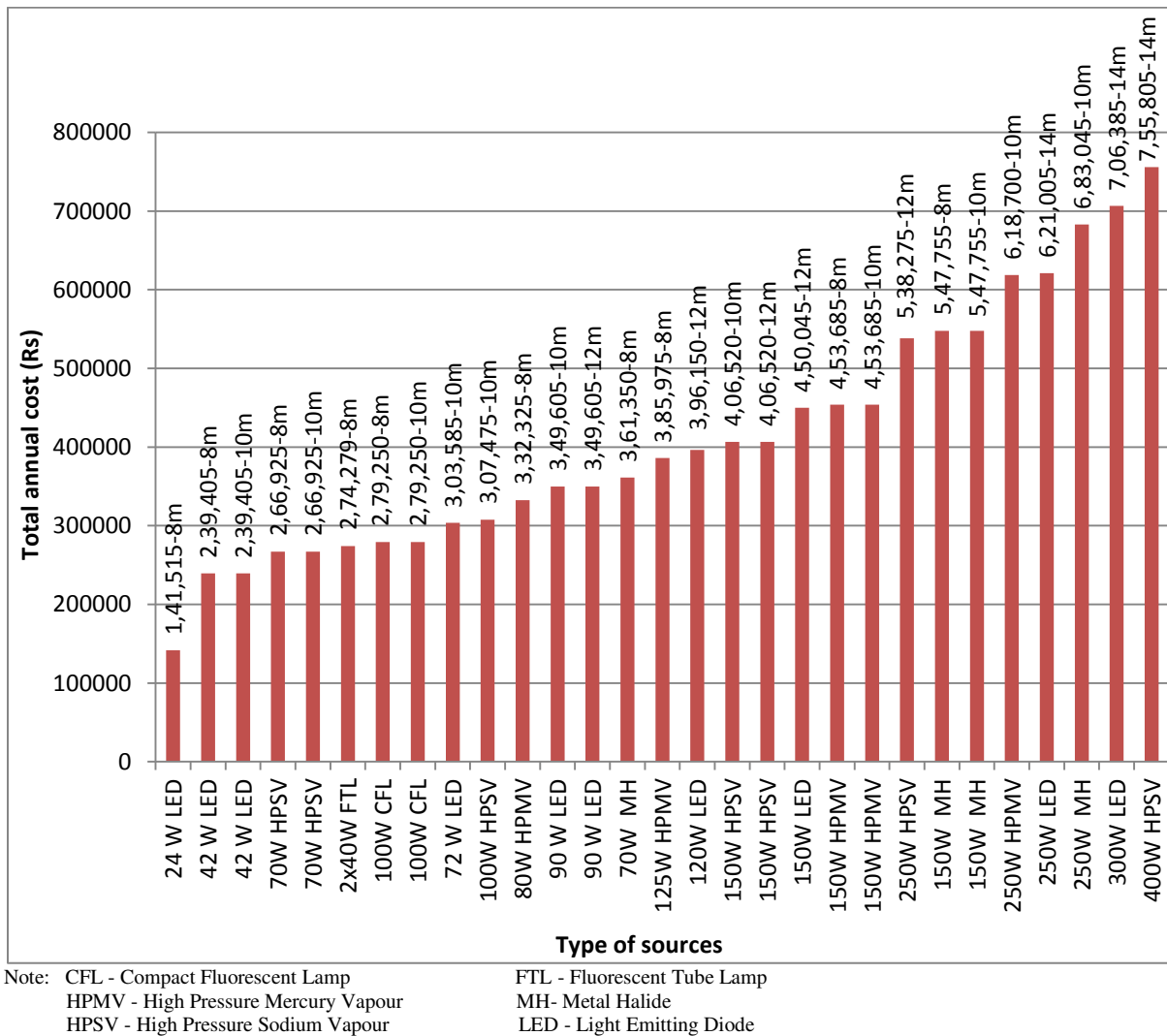

Fig. 8.2 Bar chart showing total annual cost for different types of lighting systems

As shown in Figure 8.2, the total annual cost is the minimum for 24W LED(₹ 1,41,515/-) sources and it is the maximum for 400 W HPSV lamps (₹ 7,55,805/-). By comparing bar diagrams shown in Figures 8.1 and 8.2, it can be concluded that in spite of minimum energy consumption, the total annual cost may not be low when compared to other types of lighting systems.

For example, though the energy consumption for 70W MH and 90W LED sources are almost the same, the total annual cost for 70W MH source is ₹ 11,745/- more than that of 90W LED source. Similarly, the annual cost for 80W HPMV source is ₹ 24,850/- more than that of 100W HPSV source, in spite of nearly equal energy consumption. This is mainly because of the characteristics of the individual sources and its performance at different mounting heights.

8.4 Design of Mine Lighting

Using developed cost model total annual cost of existing lighting systems (part of the lighting systems is considered) is calculated for three mines, i.e. Mine-A, Mine-B and Mine-C. Redesign of these lighting systems is done based on the optimum design parameters evolved, as explained in Chapter 6. To study the effect of lamps (i.e. type and its wattage) on design of lighting systems, existing system is redesigned with different types of light sources. The types of sources are selected based on optimum energy consumption (as given in Table 6.7 of section 6.3) and total annual cost (as given in Table 6.10 of section 6.4), as obtained in Chapter 6.

8.4.1 Design of lighting system for Mine-A

In Mine-A, as a case study, a stretch of haul road of length 860m is considered. This stretch of roadway was illuminated by 2x40W FTL lamps. There were in total 43 poles of height 8m. The intervals between the poles were not uniform. The existing lighting system is redesigned (with 2x40W FTL lamps) by adopting optimum design parameters, as obtained in Chapter 6. Further, to economise the existing lighting system, the entire stretch of roadway is redesigned with another five types of sources (i.e. 100W HPSV, 70W HPSV, 80W HPMV, 70W MH and 24W LED) by adopting optimum design parameters, as given in Table 6.6.

Using cost programme the total annual cost is computed for existing and redesigned lighting systems.

The total annual cost of the different lighting systems is given in the Table 7.3(b) (of section 7.1). Using the data from Table 7.3(b), a bar chart is drawn (shown in Figure 8.3), by plotting type of sources along X-axis and total annual cost along Y-axis. As shown in Figure 8.3, when the lighting system is redesigned with existing source, by adopting optimum design parameters (so as to fulfil the minimum lighting standards) , there is an increase of ₹ 24,293/- (11.45% increase) in total annual cost.

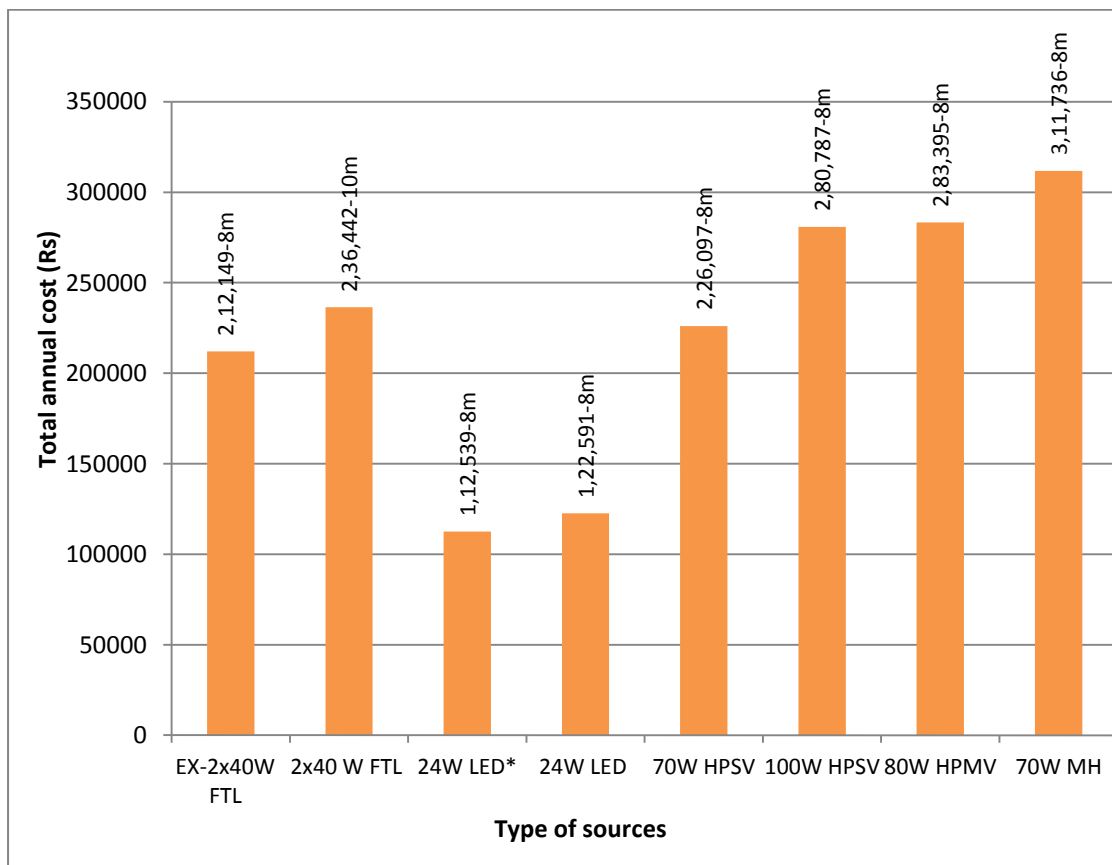

Note: FTL - Fluorescent Tube Lamp
 MH- Metal Halide
 LED - Light Emitting Diode
 HPMV - High Pressure Mercury Vapour
 HPSV - High Pressure Sodium Vapour

Fig. 8.3 Bar chart showing total annual cost for various types of sources

But when the system is redesigned with 70W HPSV and 24W LED sources, the annual cost will be below the redesigned system with 2x40W FTL sources. Among six types of sources the annual cost is the minimum for LED sources (i.e. ₹ 1,22,591/-). There is a reduction of 48.15% in annual cost when compared to redesigned system with existing light

source. By incorporating micro controller based photosensor in LED sources, the annual cost is further reduced to ₹ 1,12,539/-. This is mainly because of saving of ₹ 10,052 in annual running cost.

The average life of LED source is much more when compared to other conventional sources, and also it is very efficient (i.e. high luminous efficacy, lumens/watt). Further, LED sources can be operated with lower voltage level, even up to 30% to 60% of the rated voltage, wherein conventional sources cannot be operated. Because of these reasons in large lighting projects, there will be considerable reduction in annual running cost. It is worth to mention here in recent days, the price of LED lamps has dropped considerably.

8.4.2 Design of lighting system for Mine-B

In Mine-B, as a case study, a stretch of haul road of length 420m is considered. This stretch of roadway was illuminated by 250W MH lamps. There were in total 18 poles of height 12m. The intervals between the poles were ranging from 22m to 25m. The existing lighting system is redesigned (with 250W MH lamps) by adopting optimum design parameters, as obtained in Chapter 6. Further, to economise the existing lighting system, the entire stretch of roadway is redesigned with other four types of sources (i.e. 70W HPSV, 70W MH, 80W HPMV and 24W LED) by adopting optimum design parameters, as given in Table 6.6. Using cost programme the total annual cost is computed for existing and redesigned lighting systems.

The total annual cost of the different lighting systems is given in the Table 7.6(b) (of section 7.2). Using the data from Table 7.6(b), a bar chart is drawn (shown in Figure 8.4), by plotting type of sources along X-axis and total annual cost along Y-axis. As shown in Figure 8.4, when the lighting system is redesigned with existing source (i.e. with 250W MH sources), by adopting optimum design parameters (so as to fulfil the minimum lighting standards), there is an increase of ₹ 27,947/-. (10.96% increase) in

total annual cost. But in case of redesigned lighting systems with 70W HPSV, 70W MH, 80W HPMV and 24W LED sources, the annual cost is less than that of redesigned lighting system with 250W MH sources. Among five types of sources, which are considered for redesigning, the annual cost is the minimum for LED sources (i.e. ₹ 60,934/-). There is a reduction of 78.45% in annual cost with LED sources when compared to redesigned system

with existing light source (i.e. 250W MH). By using micro controller based photosensor in LED sources, the annual cost is further reduced to ₹ 56,006/-. This is mainly because of saving of ₹ 4,928/- in annual running cost.

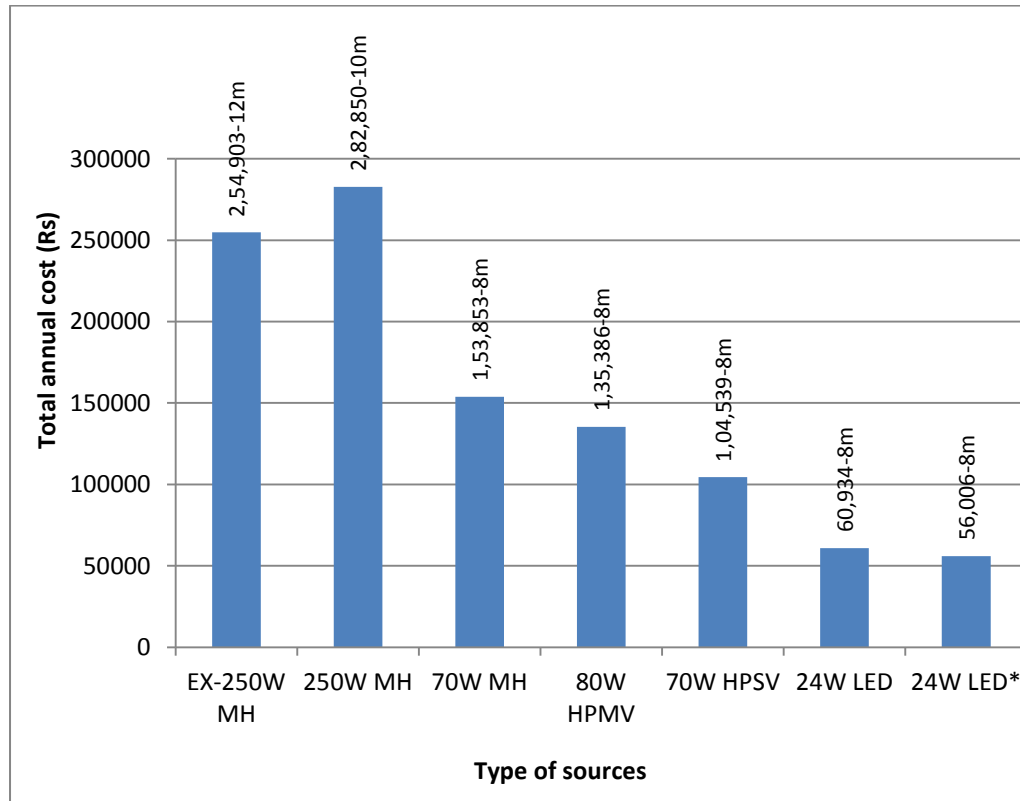

Note: FTL - Fluorescent Tube Lamp
 MH- Metal Halide
 LED - Light Emitting Diode
 HPMV - High Pressure Mercury Vapour
 HPSV - High Pressure Sodium Vapour

Fig.8.4 Bar chart showing total annual cost for various types of sources

8.4.3 Design of lighting system for Mine-C

8.4.3.1 Haul road lighting

In Mine-C, as a case study, a stretch of haul road of length 578m is considered. This stretch of roadway was illuminated by 400W HPSV lamps. There were in total 19 poles of height 12m. The intervals between the poles were ranging from 20m to 42m. The lighting system is redesigned with existing source (i.e. 400W HPSV lamps) by adopting optimum design parameters, as obtained in Chapter 6. Further, to economise the existing lighting system, the entire stretch of roadway is redesigned with other four types of sources (i.e. 70W HPSV, 70W MH, 80W HPMV and 24W LED) by adopting optimum design parameters, as given in

Table 6.6 (of section 6.2). Using cost programme the total annual cost is computed for existing and redesigned lighting systems.

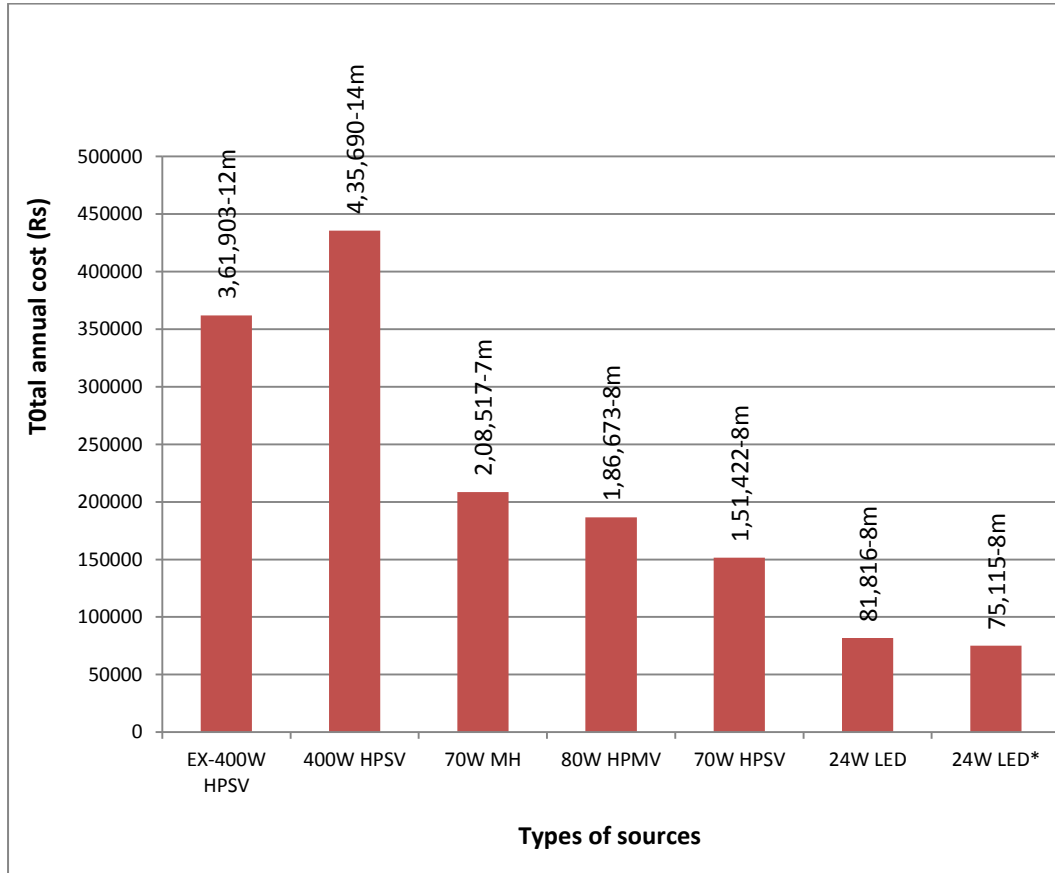

Note: FTL - Fluorescent Tube Lamp
MH- Metal Halide
LED - Light Emitting Diode

HPMV - High Pressure Mercury Vapour
HPSV - High Pressure Sodium Vapour

Fig. 8.5 Bar chart showing total annual cost for various types of sources

The total annual cost of the different lighting systems is given in the Table 7.9(b) (of section 7.3.1). Using the data from Table 7.9(b), a bar chart is drawn (shown in Figure 8.5), by plotting type of sources along X-axis and total annual cost along Y-axis. As shown in Figure 8.5, when the lighting system is redesigned with existing source, by adopting optimum design parameters (so as to fulfil the minimum lighting standards), there is an increase of ₹ 27,947/- (20.38% increase) in total annual cost. But in case of redesigned lighting systems with 70W HPSV, 70W MH, 80W HPMV and 24W LED sources, the annual cost is less than that of redesigned lighting system with 400W HPSV sources. Among five types of sources, which are considered for redesigning, the annual cost is the minimum for LED sources (i.e. ₹ 81,816/-). There is a reduction of 81.22% in annual cost when compared to redesigned

system with existing light source. By adding micro controller based photosensor in LED sources, the annual cost is further reduced to ₹ 75,115/-. This is mainly because of saving of ₹ 6,701/- in annual running cost.

8.4.3.2 Area lighting

In Mine-C for area lighting, such as stack yard, dump yard, mine site office and crusher point 250W and 400W HPSV sources were used. In total there were five 400W sources and two 250W sources. Table 7.10 (of section 7.3.2) gives the details of the lighting installations. Since, in many patches the light level was below 3.0lux (i.e. the minimum illuminance level specified by DGMS), the existing lighting system is redesigned with seven numbers of 250W LED sources (without considering uniformity ratio). Table 7.13 (of section 7.3.2) gives the details of proposed lighting system. Using cost programme the total annual cost is computed for existing and proposed lighting systems. Table 7.16 gives the total annual cost along with the annual energy consumption. As indicated in Table 7.16 (of section 7.3.2), the total annual cost of the existing lighting system is ₹ 1,26,290/- and that of proposed system is ₹ 1,43,400/-. Though, there is an increase of ₹ 17,110/- with the redesigned system, this amount is meagre when compared to saving in energy per annum (of the order 3285KWhr), costing ₹ 24,637/-. As it is demonstrated in Chapter 6, any lighting system offering less energy consumption, will have lower annual cost in long run.

8.4.4 Overall discussion about case study

As a case study three mines (one limestone mine, which is designated as 'A' and two coal mines which are designated as 'B' & 'C') have been selected and their existing lighting systems have been redesigned based on the optimum lighting design parameters, as obtained in the Chapter 6. For redesign of lighting system, an optimum tilt angle of 14° was maintained with light source 2m beyond the kerb side of the roadway. This also facilitates easy movement of HEMM. In total five mounting heights (i.e. 8m, 10m, 12m, 14m and 16m) were selected for the purpose of redesign. From all the three mines a stretch of a roadway has been selected and their lighting systems were redesigned with different types of light sources. The redesign was made based on the guidelines stipulated by the DGMS, CIE and BIS. Because in many places in the mines the light levels were below the minimum lighting standard, as specified by the DGMS. In Mine A, the lighting system was redesigned for

860m length of roadway with six types of sources, such as 2x40W FTL, 100W HPSV, 70W HPSV, 80W HPMV 70W MH and 24W LED. In Mine B, the lighting system was redesigned for 420m length of roadway with five types of sources, such as 250W MH, 70W HPSV, 70W MH, 80W HPMV and 24W LED. Similarly, in Mine C the lighting system was redesigned for 578m length of roadway with five types of sources, such as 400W HPSV, 70W HPSV, 70W MH, 80W HPMV and 24W LED. Further, in Mine C the lighting system was also redesigned for stack yard, dump yard, mine site office and crusher point. In all the case studies it was observed that LED lamp is offering the most economic lighting system when compared to conventional light sources.

In Mine A the total reduction in the annual lighting cost would be 48.15% by redesigning the system with 24W LED sources, where as in case of Mine B it would be 78.45%. Similarly, In case of Mine C the reduction in annual cost would be 81.22%. A close look at this annual illumination cost of three case studies shows that the running cost of the lighting system increases with increase in wattage of the source and in turn the more number of lower wattage sources offers least running cost. Because of more life and high efficacy, the running cost of LED sources is quite low when compared to other conventional sources. By running the LED sources at 50% rated voltage (i.e. by using micro controller based photo sensor) the total annual cost of illumination system would be further reduced. The redesign of lighting system for four areas (i.e. stack yard, dump yard, mine site office and crusher point) in Mine C also shows that there would be considerable reduction in annual cost by using LED sources.

CHAPTER 9

CONCLUSIONS AND SCOPE FOR FUTURE WORK

9.1 CONCLUSIONS AND RECOMMENDATIONS

1. In mines, in general, poles are erected beyond the kerb of the road, so that the movements of Heavy Earth Moving Machinery (HEMM) are not disturbed by the lighting installations. Since the poles are installed beyond the kerb, luminaires are fitted with some tilt angles, so as to illuminate the full width of the roadway. This restricts the direct application of fundamental lighting law, namely the cosine law. Since the illuminating surface is not perpendicular to the axis of luminaire, a mathematical model has been developed keeping this aspect in view. The computer programme developed using MATLAB by considering the influence of tilt angle for each and every grid point of illuminating surface. The programme computes the light level at any given point taking into consideration of the cumulative effect of the luminaires.
2. The equations for computation of cost of mine lighting have been suitably modified taking care of maintenance system prevailing in Indian mines.
3. As per the BIS guidelines, public roads illumination is regulated by overall uniformity ratio along with illuminance level. The results of this research work have shown the possibilities of introducing overall uniformity ratio in the design of illumination system for Indian surface mining industry, which is mainly regulated by minimum illuminance level as per DGMS guidelines.
4. The study on the hypothetical road of 12m width and 1km length reveals that out of twenty two types of sources considered for the design, 24W LED lamps mounted on 8m height poles placed at 17m intervals, with arm length 0m at a tilt angle 14° offer the most suitable lighting system based on optimal cost considerations. Among conventional sources, 70W HPSV lamps mounted on 8 to 10m height poles placed at 19 m intervals, with arm length 0m at a tilt angle 14° offer the lowest annual cost, for the lighting system designed for minimum illuminance level of 0.5lux with 0.3 uniformity ratio.

In large lighting projects, the lighting systems are selected based on its total annual cost. But for small projects, generally lighting systems are decided based on optimal energy considerations. The present work also demonstrates this concept. For example, in the present study, for the same 1km length roadway, 72W LED lamps with arm length 0m at a tilt angle 14° mounted on 10m height poles placed at 20m intervals shows an optimal energy consumption (i.e. 15768KW-hr) when compared to 70W HPSV sources (16249KWh). However, the total annual cost of the lighting system with 72W LED sources (i.e. Rs. 3,03,585/-) is significantly more than that of 70W HPSV lamps (i.e. Rs. 2,66,925/-).

5. For the case study, the light level was measured in three mines, namely Mine-A, Mine-B and Mine-C, and it was observed that at many places the illuminance levels was below the minimum required lux level of 0.5. Also the light distribution was not uniform (i.e. not satisfy the overall uniformity ratio of 0.3) in these places. To study the importance of optimum design parameters in mine lighting, a part of illumination system was considered from all three mines and were redesigned with different types of light sources.

In Mine-A, by adopting the optimal design parameters evolved in this study, the minimum required lighting standards could be fulfilled and the total annual cost would come down to approximately 47%. Similarly, in Mine-B and Mine-C the total annual cost would come down to 76% and 77%, respectively. This clearly demonstrates the importance of scientific design of lighting system.

6. Case study with respect to area lighting exhibited that the high wattage conventional sources can be suitably replaced by 250W LED lamps with arm length 0m at a tilt angle 14° mounted at a height 8m, as it offers low energy consumption and it also fulfil the required lighting standards.
7. The present study demonstrates that the LED (250W and 300W) sources are showing better performance and consume less energy at greater mounting heights. This also corroborates with the literature. For example LED sources (such as 250W and 300W) offers low energy consumption at 14m mounting height, whereas LED sources (such as

90W, 120W and 150W) are showing optimum energy consumption at lower mounting heights (i.e. 12m and 10m), by fulfilling minimum required lighting standards.

8. Recommended design parameters for haul road illumination based on developed lighting design model as well as field study are given below:

- In mines, light poles should be installed beyond the kerb of the road, so as not to restrict the movement of machinery, and also the mounting height of the lamps should be governed by HEMM of maximum height plying on that road. Pole height may be varied from 8m to 14m for haul roads of 12m width, which is usually prevailing in Indian mines. For sources (such as 24W, 42W, 70W, 80W, 100W, 150W and 250W), the height of poles could be 8m, 10m and 12m, and for sources (such as 250W, 300W and 400 W) it could be 12m or 14m.
- Intervals between poles depend upon the mounting height and luminous intensity distribution characteristics of luminaire. Pole interval must be uniform to achieve uniform distribution of light and for better visual performance. As a thumb rule, for standard haul roads of 12m width, the interval between the poles would be approximately two times the height of poles depending upon the luminaire characteristics.
- Indian mining regulations specify only minimum illuminance level. But BIS and CIE stipulates uniformity ratio along with minimum illuminance level. In the present work, all these aspects have been taken into consideration and it is demonstrated that for Indian surface mines, the lighting system can be designed based on minimum illuminance level and overall uniformity ratio.
- Lamp selection is made mainly based on efficacy and suitability to each situation. Because of high luminous flux, LED sources offer low total annual cost, with lowest energy consumption. However, due to efficient penetration character in dusty environment, which is generally encountered in surface mines, HPSV lamps are giving very good performance. Among HPSV sources, 70W lamps are showing lowest annual cost, for lighting standards specified for Indian mines.
- HPSV and LED lamps are recommended for surface mine lighting as they have high luminous flux compared to other types of light sources.

9.2 SCOPE FOR FUTURE WORK

- Light falling on the surface is also affected by various environmental parameters. For example, in surface mines dust plays a vital role in reducing the intensity of light. In this regard, the effect of dust/fog on the performance of luminaires can be studied.
- Design of illumination system for working face requires the knowledge of indirect light coming from the surroundings, which may be incorporated in the design model.
- Reflectance study of rock surfaces like gold ore, coal and iron ore etc can be performed for different types of sources to know the influence of reflectance property on luminance under various operating parameters.
- Similar studies shall be carried out for underground mines for design of lighting system and for development of optimum design parameters.

REFERENCES

- Anon. (1948). "Illumination Design for Interiors." *Issued by The Lighting Service Bureau, London.*
- Anon. (1954-55). "Report of The Mine Lighting Sub Committee To The National Illumination Committee of Great Britain." *Transactions of the Institution of Mining Engineers*, 114, 189-220.
- Anon. (1961). "Good Lighting..... What It Means in Coal Mining." *Coal Age*, June, 85-90.
- Anon. (1974). "Factors To Be Considered In Lighting Design." *Lighting Design and Application*, 4(4), April, 38-39.
- Anon.(1975). "Occupational Safety and Health Effects Associated with Reduced Levels of Illumination." *A summary of the NIOSH symposium on the potential effects of reduced light levels, Lighting Design and Application*, 5(8), August, 29-32.
- Anon. (1976). "Coal Mine Illumination." *US Bureau of Mines Information Circular 8709.*
- Anon. (1976). "Mine Illumination." *US Department of the Interior, Mining Enforcement and Safety Administration. Programmed Instruction Workbook No.8.*
- Anon. (1983). "Roadway Lighting Handbook." *Department of Transportation*, September.
- Anon. (1984). "Effective Mine Lighting Increases Safety, Productivity." *Canadian Mining Journal*, July, 29-30.
- Anon. (2004). "Lab Notes of Light Lab International Pty. Ltd." www.lsa.com.au (accessed on 26th December).
- Anon. (1993). "IES Lighting Handbook." *Reference & Application Volume*, Illuminating Engineering Society of North America, 8th edition.
- Adrian, W. (2002). "The Spectral Reflectance of Road Surfaces and Resulting Luminances in MH and HPS Light." *Light Newsletter*, Indian Society of Lighting Engineers, III (I), January, 19-20.

- Anil Valia. (2014-15) "Designing with light." *International lighting academy*.
- Boast, B. W. (1942). "Illuminating Engineering." *McGraw-Hill Book Co. Inc*, New York.
- Bright, A. A. (1949). "The Electric Lamp Industry." *Published by The Macmillan Company*, New York.
- Barr, A.C and Amick, C.L. (1952). "Fundamentals of Lighting Cost Analysis." *Illuminating Engineering*, 21(6), May, 260-264.
- Black, W. F. (1956). "The Effect of a Dirty Atmosphere on The Output of Lighting Fittings." *Light and Lighting*, 49(12), December, 362-365.
- Bell, B. W. and O'Sullivan, E. P. (1964). "Lighting of Opencast Coal Mines." *Proceedings of a symposium organized by the Institution of Mining and Metallurgy in cooperation with the Institution of Mining Engineers and the Institute of Quarrying*, U.K., 659-667.
- BIS (Bureau of Indian Standards). (1966). "Code of Practice for Interior Illumination." *IS: 3646 (Part I)*.
- Bell, B. W. (1972). "Lighting in Coal Mines." *Proceedings of the Symposium on Environmental Engineering in Coal Mining*, London, November, 63-71.
- Baines, A. (1972). "Environmental Aspects of Today's Mining Industry." *Mining Engineer*, 131, 351-358.
- Bommel, V. I. W. J. M. and de Boer, J. B.(1980). "Road Lighting." *Philips Technical Library*, Kluwer Technische Bocken B. V., Deneter-Antwerpen.
- Best, C.F, Graveling, R.A, Graves, R.J, Leamon, T.B, Simpson, G.C. and Sims, M.T. (1981). "Visual Requirements and Lighting Standards in Mining Operations." *Final Report on CEC Contract 6245-11/8/048*, Institute of Occupational Medicine Edinburgh, 90.
- Bell, W.B. (1982). "The design of efficient lighting systems for deep coal mines." *Australian Journal of Coal Mining*, 2, 1-15.

- Beckett, G. (1982). "Mine Illumination Survey." *US Bureau of Mines Information Circular 8886*, 63-73.
- Bandhopadhyay, K. P. (1989). "Lighting of Open Cast Mines." *Proceedings of National Conference on Lighting for 21st century*, Bangalore, 36-41.
- Bandhopadhyay, K. P. (1991). "Lighting of Open Cast Mines." *Proceedings of International Conference on Lighting Technology*, Prakash-91, New Delhi, 254-259.
- BIS (Bureau of Indian Standards).(1991). "Code of Practice for Lighting of Public Throughfares." *IS:1944 (Parts I&II)*.
- Burton, L. J. (1991). "Fundamentals of Interior Lighting – Vol. I." *Building System and Design Series*, Prentice Hall, Columbus, Ohio.
- Cotton, H. (1960). "Principle of Illumination." Chapman & Hall Ltd., First Edition.
- Central Mining & Research Station (CMRS). (1963). "Illumination Survey In The Indian Coal Mine." *Research paper no. CMRS-V3/5*, Dhanbad, February.
- CIE (Commission Internationale de L'Eclairage, Austria).(1973). "Photometry of luminaires for street lighting." *Publication No. 27 (TC – 2.4)*.
- Chironis, P. N. (1974). "Underground Mine Lighting..... A Look At What's New In Concepts And Equipment." *Coal Age*, August, 66-74.
- CIE (Commission Internationale de L'Eclairage, Austria). (1976). "Street Lighting and Accidents." *Publication No. 30*.
- Crooks, W.H. and Peay, J.M. (1981). "Developing luminance requirements for underground metal and nonmetal mines." *In Bureau of Mines Information Circular IC 8866*, United States Department of the Interior.
- Crouch, L. C. (1982). "Disability Glare Studies On Underground Mine Personnel." *US Bureau of Mines Information Circular 8886*, 186-191.

- Crooks, H. W. and Peay, M. J. (1982). "Definition of Illumination Requirements For Underground Metal And Non-metal Mines." *US Bureau of Mines Information Circular* 8886, 319-333.
- CIE (Commission Internationale de L'Eclairage, Austria). (1988). "Guide to The Lighting for Opencast Mines." *Publication No. 128*.
- CIE (Commission Internationale de L'Eclairage, Austria). (1999). "Design Methods for Lighting of Roads." *Publication No.132*.
- CIE (Commission Internationale de L'Eclairage, Austria). (1999). "Standardisation for Grids." *Publication No. BS 5489 Part 3*.
- Don, S. J. (1948). "Light In Daily Life." *The Technical Press Ltd*, London.
- Dutt, P. D. and Baghi, S. (1960). "Light and Seeing." *Mines, Metals & Fuels*, VIII (8), 1-3.
- DGMS (Directorate General of Mines Safety, India). (1976). "Circulars." *Circular (Legis.)* 1/1976 and 3/1976.
- Durrant, W. D. (1977). "Interior Lighting Design." *Published jointly by the Lighting Industrial Federation Ltd. and the Electricity Council*, Fifth Edition, London, April.
- DGMS (Directorate General of Mines Safety, India). (1992). "Circulars." *Tech. No. 3/1992*.
- DGMS (Directorate General of Mines Safety, India). (1995). "Circulars." *Tech. No. 2/1995*.
- Daniel Frering, L.C. (2010). "Vision, Human Factors, and Health." *Conducted workshop by ISLE_LRC © Rensselaer Polytechnic Institute*, December.
- ECSC (European Coal and Steel Community). (1990). "Guidelines on the ergonomics of underground illumination in coal mines." *Community ergonomics Action Report No15, series 3*, 92.
- Ginhorn, D. H. (1958). "Colour Science and Lighting Practice." *Light and Lighting*, . 51(9), September, 303-308.

- Glanville, W. (1960). "Light and Road Safety." *Transactions of The Illuminating Engineering Society*, London, 25(2), 69-84.
- Gardner, C. (2002). "Re-Valuating the Pedestrian: A New Approach to Urban Lighting, Light Newsletter." *Indian Society of Lighting Engineers*, II(I), January, 10-11 & 16-19.
- Guptha, B. J. (2012). "Utilisation of Electric Power and Electric Traction." *S. K. Kataria & Sons*, New Delhi, 10th Edition, 277-340.
- Howell, W. J. (1937). "Colliery Lighting." *Light and Lighting*, vol. XXX, 2, February, 38-40.
- Harries, J. A. (1957). "Visibility on The Road." *Transactions of The Illuminating Engineering Society*, London, 22 (9), 243-269.
- Henderson, T. S. and Marsden, M. A. (1972). "Lamps and Lighting." *Edward Arnold*, London.
- Homes, G. J. (1975). "Essays on Lighting." *Adam Higher*, London.
- Hottinger, D. D., Faux, K. R. and Yantz, R. O. (1982). "Illuminating Large Surface Mining Machines, Problems and Solutions." *US Bureau of Mines Information Circular 8886*, 271-304.
- IES (Illuminating Engineering Society of North America). (1993). "Lighting Handbook." *Reference & Application*, New York, 989.
- Kumar, S. and Paul, R. M. (1966). "Desirable Illumination Levels In Indian Coal Mines- An Investigation." *Research paper no. 29, CMRS-V13/29, Central Mining & Research Station (CMRS)*, December, Dhanbad.
- Kurian, P. C., Aithal, S. R., Bhat, J. and Colaco, G. S. (2002). "MATLAB'S Power for Interior Lighting Design." *Proceedings of International Symposium, Lux Pacifica*, September, 260-263.

- Karmakar, C. N. and Chauhan, S. B. (2002). "Illumination Survey And Cost Analysis For Large Scale Open Cast Coal Mine." *Indian Mining & Engineering Journal*, April, 29-32.
- Karmakar, C. N. and Chauhan, S. B. (2004). "An Economic Analysis on Lighting of Opencast Mines By Light Tower." *Minetech*, 25(4), Jul-Aug, 18-27.
- Lewis, H. W. (1986). "Underground Coal Mine Lighting Handbook." *Part 1: Background*, *US Bureau of Mines Information Circular 9073*.
- Lewis, H. W. (1986). "Underground Coal Mine Lighting Handbook." *Part 2: Application*, *US Bureau of Mines Information Circular 9073*.
- Peretiatkoniez, A. (1982). "Problems of Electric Mine Lighting In The Work of CIE." *US Bureau of Mines Information Circular 8886*, 32-42.
- Mayton, G. A. (1987). "Assessment and Determination of Illumination Needs for Operators of Mobile Surface Mining Equipment." *US Bureau of Mines Information Circular 9153*.
- Mayton, G. A. (1991). "Investigation of Task Illumination for Surface Coal Mining Equipment Operators." *Journal of the Illuminating Engineering Society*, Winter, 2-18.
- Mehtha, L. (2003). "Energy Saving and Latest Trend in Road Lighting." *Light Newsletter*, *Indian Society of Lighting Engineers, Mumbai*, III (IV), October.
- Pandey, P. (1990) "Lighting in Underground Mines." *Minmag (BHU)*, India, XX, December, 79-89.
- Roberts, A. (1962). "Lighting Mechanised Mining Operations." *Journals of Mines, Metals & Fuels, Special Issue*, 454-459.

- Radhakrishna, S. Aithal, B. Ghosh, Saswathi Mazumdar & Adiga, K.V. (1999). "Toward more Authentic Approach for Energy Savings in Roadway Lighting." *International Conference on Lighting Technology*, Prakash 99, ISLE New Delhi, October, 29 –31.
- Rushworth, A.M. (2001). "Final Project Report, The Role of Illumination in Reducing Risk to Health and Safety in South African Gold and Platinum Mines." *SMRAC (Safety in Mines Research Advisory Committee), GAP 804*.
- Reimann, M. (2003). "Coast to Coast Connection." *Light Newsletter, Indian Society of Lighting Engineers*, III (I), January, 12-13.
- Sarkar, M. N. I. (2016) "Estimation of solar radiation from cloud cover data of Bangladesh" *Renewables: Wind, Water, and Solar*, Springer Open Journal, 3(11).
- Schaffer, F. (1961). "Lighting and Accidents." *Licht und Beleuchtung*, 9(1), 1-4 Vienna.
- Senguptha, M. (1990). "Mine Environmental Engineering." *CRC Press, Inc.*, Boca Raton, Florida, vol. II, 77-102.
- Skinner, S. C. (1987). "How To Implement Mine Illumination." *Coal Mining and Processing*, 16(3), 83-86.
- Strachan, A. D., Mauric, M. M. and Peat, A. T. (1955). "Lighting by Means of Pneumatic Electric Units." *Report of the Mine Lighting Sub Committee of Great Britain, Transactions of the Institution of Mining Engineers*, 114, 189 – 220.
- Trotter, D. (1977). "Mine Lighting." *Canadian Mining Journal*, no. 7-12, July-Dec, 24-31.
- Trotter, D. and Laferriere, L. (1980). "Glare Reduction for Underground Lights." *Canadian Mining Journal*, 101(8), September, 37- 44.
- Trotter, A. D. (1982). "The Lighting of Underground Mines." *Trans Tech Publications*, West Germany, First Edition.
- Trotter, D. (1982). "Reflectance Measurement In Mining." *US Bureau of Mines Information Circular 8886*, 55-171.

- Weale, S. R. (1961). "Retinal Illumination and Age." *Transactions of The Illuminating Engineering Society, London*, 26(1), 95-100.
- Waldrew, M. J. (1961). "Vision Problems on Motorways." *Transactions of The Illuminating Engineering Society, London*, 26(2), 66-78.
- Weston, C. H.(1961). "Rationally Recommended Illumination Levels." *Transactions of The Illuminating Engineering Society, London*, 26(1), 1-16.
- Yingling, J. (1982). "Coal Industry Experience With Mine Illumination System: Maintenance Requirements And Personnel Acceptance." *US Bureau of Mines Information Circular 8886*, 237-260.

BOOKS

- Bajaj. (2012). "Manufacturers Catalogue."
- Colin J. Marsh. (2009). "Key Concepts for Understanding Curriculum." Routledge Publisher.
- Canara Lighting Engineers. (2012). "Manufacturers Catalogue."
- John, M. C. (2011), "Basic Statistics" *Penn State University* Latest revision 26 August 2011.
- Kaku, L. C. (1957). "The Coal Mine Regulations." *Lovely Prakashan, Dhanbad*.
- Kejriwal, K. B. (2004). "Safety in Mines." *Lovely Prakashan, Dhanbad*.
- KAHRAMAA. (2010). "Regulations for the Installation of Electrical Wiring, Electrical Equipment and Air Conditioning Equipment" *Qatar General Electricity & Water Corporation, Customer Services Department State of Qatar Edition, December*.
- KPWDSR (Karnataka Public Works Department Schedule of Rates). (2014-15). "Electrical." India.
- Lynch, K. D. and Livingstone, W. (1995). "Colour and Light In Nature." *The Press Syndicate of the University of Cambridge University, USA*.

- LRC (Light Research Center). (2000). "Illumination Fundamentals by Lighting." *LRC © Rensselaer Polytechnic Institute*.
- Lighting manual-Philips. (2009).
- Lyons, S.L. (1980). "Exterior Lighting for Industry and Security." *Applied Science Publishers Ltd., England*.
- Lyons, L. S. (1981). "Handbook of Industrial Lighting." *Butterworth & Co. Ltd., London*.
- Moon, P. and Speneer, E. D. (1948). "Lighting Design." *Addison- Wesley Press Inc, USA*
- Ronald, H. N. (1980). "Illumination Engineering for Energy Efficient Luminous Environment." *Prentice-Hall, New Jerce, First Edition*.
- Philips. (2012). "Manufacturers Catalogue."
- PutriZalilaYaacob and Dr. Abdullah AsuhaimlMohd.Zin,(1993) "Electrical Energy Management in Small and Medium Size Industries", FEE, UTM, K. Lumpur, IEEE TENCON'93/ Beijing.
- Ronald, H. N. and Belcher, C. M. (1991). "Lighting for Energy Efficient Luminous Environments." *Published by Prentice-Hall, New Jerce, Second Edition*.
- Sawhney,A.K. (1992)."A course in electrical machine design", Dhanpatpai & Son.
- Sigma Search Lights. (2009). "Manufactures Catalogue."
- Stephen, P. R. (1970). "Organizational Behavior." *Pearson Education, Asia, 9th Edition , 588-591*.
- Tripathy, S. C. (1991). "Electric energy utilization & conservation." *Publisher-Tata McGraw-Hill, London*.
- Uppal, L. S. (2013). "Electrical Power." *Khanna Publishers, New Delhi, fifteenth edition, 1522-1587*.

Walsh, Y. J. (1958). "Planned Artificial Lighting." *Odhams Press Ltd*, London, Second edition
Wadhwan, L. C. (1990). "Generation, Distribution and Utilisation of Electrical Energy." *Wilcy Eastern Limited*, Delhi, First reprint.

Zijl, H. (1995). "Illuminating Engineering Course." *Philips Technical Library*, Netherland.

WEBSITES

Encyclopedia. (2010). "Light-emitting diode – Wikipedia." *Wikipedia® Wikimedia Foundation, Inc.* <http://www.che.utah.edu/~ring/Design%20I/Articles/LED%20-%20Wiki...pdf> /http://en.wikipedia.org/wiki/Light-emitting_diode.

Lamptech .(2016). "Welcome to the Museum of Electric Lamp Technology" <http://www.lamptech.co.uk/index.html>. Lamptech © J.D. Hooker 2002 – 2016.

Nave, R. (2016) "Inverse Square Law, Light" <http://hyperphysics.phy-astr.gsu.edu/hbase/vision/isql.html>.

Richard Forster. (2012). "Encyclopaedia of Occupational Health and Safety from the International Labour Office." <http://www.ilocis.org/documents/chpt46e.htm>.

Website of BEE, SCCL, Ministry of coal, Ministry of power.

<http://www.mathworks.com>.

Williamson and Cummins, T.R. (2004). "The Rods and Cones of the Human Eye" *Hyper Physics*, <http://hyperphysics.phy-astr.gsu.edu/hbase/vision/rodcone.html> (Mar. 2011).

ANNEXURE - I

Table-1: Luminous intensity values for different C- γ values for 70W HPSV lamp

$\gamma \setminus C$	0	5	10	15	20	25	30	35	40	45	50	55	60	65	70	75	80	85	90	95	100	105	110	115	120
0.00	213	212	213	211	213	213	213	213	212	213	213	213	214	214	214	214	214	214	214	214	214	214	214	214	214
2.50	219	218	219	218	220	217	220	216	218	213	215	214	211	210	210	209	209	208	208	208	209	209	210	210	211
5.00	219	220	221	221	221	221	221	221	220	220	220	220	221	219	214	212	210	208	208	208	210	212	214	219	221
7.50	217	219	221	222	223	224	227	226	231	231	227	224	223	222	223	221	218	210	209	210	218	221	223	222	223
10.00	226	228	229	231	230	230	228	228	227	227	229	230	230	229	225	222	218	210	208	210	218	222	225	229	230
12.50	235	232	232	235	235	235	238	235	232	230	228	227	227	225	222	219	215	207	206	207	215	219	222	225	227
15.00	241	239	239	242	242	243	248	245	241	236	231	226	222	219	219	218	216	214	213	214	216	218	219	219	222
17.50	248	239	241	244	244	244	254	252	247	243	236	229	223	219	218	217	217	218	218	218	217	217	218	219	223
20.00	246	240	243	247	248	247	258	255	250	247	239	232	225	219	213	210	209	213	213	213	209	210	213	219	225
22.50	245	239	244	247	248	248	258	254	250	245	239	232	225	218	208	204	203	208	209	208	203	204	208	218	225
25.00	243	240	254	249	250	249	258	252	246	240	235	228	220	213	202	198	197	203	204	203	197	198	202	213	220
27.50	234	233	240	244	246	245	254	250	243	236	227	220	215	208	198	194	193	199	200	199	193	194	198	208	215
30.00	219	219	229	235	237	238	248	241	240	239	232	225	209	203	194	190	189	194	195	194	189	190	194	203	209
32.50	208	210	219	226	228	226	234	229	228	225	219	215	202	197	188	184	183	187	187	187	183	184	188	197	202
35.00	197	200	210	228	217	215	220	216	211	211	203	204	192	188	182	179	178	181	181	181	178	179	182	188	192
37.50	190	194	205	216	211	203	204	200	197	195	195	194	181	179	176	174	172	170	170	170	172	174	176	179	181
40.00	183	189	199	210	202	200	194	197	190	184	183	183	169	169	167	166	165	162	161	162	165	166	167	169	169
42.50	182	187	200	204	201	200	187	180	174	169	169	170	156	157	157	157	156	153	152	153	156	157	157	157	156
45.00	181	190	207	208	206	200	182	179	170	169	157	157	152	144	145	145	145	142	142	142	145	145	145	144	152
47.50	190	203	222	224	219	211	196	182	176	170	165	157	143	125	127	127	127	126	126	126	127	127	127	125	143
50.00	197	216	242	250	245	234	226	193	185	177	172	165	124	112	114	113	112	108	107	108	112	113	114	112	124
52.50	216	241	277	317	290	270	255	233	206	171	150	140	106	98	99	98	96	92	91	92	96	98	99	98	106
55.00	230	263	310	371	355	324	299	262	230	166	139	116	97	89	87	85	83	80	79	80	83	85	87	89	97
57.50	261	312	371	486	443	413	323	255	215	144	120	95	83	78	78	76	73	69	68	69	73	76	78	78	83
60.00	264	323	414	570	541	506	365	279	189	134	115	85	74	68	71	69	67	64	63	64	67	69	71	68	74
62.50	227	290	382	535	524	493	373	281	153	132	107	84	69	60	62	59	57	55	54	55	57	59	62	60	69
65.00	223	295	390	549	521	491	304	187	104	66	106	111	80	70	61	54	50	48	47	48	50	54	61	70	80
67.50	216	282	377	521	515	479	252	146	84	49	33	27	30	34	48	52	53	45	44	45	53	52	48	34	30
70.00	185	250	332	499	485	392	218	113	64	38	29	25	25	25	27	28	28	28	28	28	28	28	27	25	25
72.50	155	201	264	371	326	257	142	82	49	30	24	21	21	21	22	22	22	22	22	22	22	22	22	21	21
75.00	130	157	211	278	223	160	100	59	36	26	21	18	18	17	18	18	18	17	17	17	18	18	18	17	18
77.50	95	111	141	185	142	101	63	39	27	20	17	15	15	14	14	14	14	14	14	14	14	14	14	14	15
80.00	70	88	108	145	95	68	45	29	21	17	15	14	14	13	12	11	11	12	12	11	11	12	13	14	14
82.50	43	56	70	85	63	44	31	21	15	13	12	11	11	10	9	9	9	9	9	9	9	9	9	10	11
85.00	14	14	20	28	20	13	12	10	9	8	8	8	7	7	8	8	8	9	9	9	8	8	8	7	7
87.50	4	5	8	10	6	4	5	4	4	3	3	3	4	5	6	6	6	6	6	6	6	6	6	5	4
90.00	3	3	5	8	5	3	3	2	2	2	2	2	2	2	2	2	2	2	2	2	2	2	2	2	2

125	130	135	140	145	150	155	160	165	170	175	180	185	190	195	200	205	210	215	220	225	230	235	240
213	213	213	212	213	213	213	213	211	213	212	213	212	213	211	213	213	213	213	212	213	213	214	214
214	215	213	218	216	220	217	220	218	219	218	219	218	219	218	218	217	217	217	217	216	216	215	214
220	220	220	220	221	221	221	221	221	221	220	219	217	218	215	217	214	214	213	213	211	212	212	211
224	227	231	231	226	227	224	223	222	221	219	217	216	215	213	211	209	208	206	204	204	205	204	204
230	229	227	227	228	228	230	230	231	229	228	226	224	221	218	213	209	205	201	199	197	196	195	195
227	228	230	232	235	238	235	235	235	232	232	235	232	228	226	221	218	209	205	198	192	189	187	185
226	231	236	241	245	248	243	242	242	239	239	241	237	233	229	223	217	212	206	200	192	184	179	176
229	236	243	247	252	254	244	244	244	241	239	248	244	238	232	224	219	211	205	197	192	183	175	170
232	239	247	250	255	258	247	248	247	243	240	246	242	235	228	221	216	207	201	195	188	180	171	164
232	239	245	250	254	258	248	248	247	244	239	245	238	230	224	215	208	202	196	189	183	175	166	159
228	235	240	246	252	258	249	250	249	254	240	243	235	226	218	209	201	194	188	182	176	169	160	152
220	227	236	243	250	254	245	246	244	240	233	234	224	214	205	198	192	185	178	173	168	160	151	143
225	232	239	240	241	248	238	237	235	229	219	219	209	200	191	184	177	173	168	162	158	150	143	135
215	219	225	228	229	234	226	228	226	219	210	208	196	185	177	172	163	158	155	151	146	140	131	123
204	203	211	211	216	220	215	217	228	210	200	197	183	173	164	158	153	146	143	140	134	128	123	117
194	195	195	197	200	204	203	211	216	205	194	190	175	165	155	148	141	139	133	130	125	118	114	110
183	183	184	190	197	194	200	202	210	199	189	183	166	156	147	141	135	130	125	119	115	106	105	103
170	169	169	174	180	187	200	201	204	200	187	182	165	153	141	133	129	124	119	113	104	102	94	88
157	157	169	170	179	182	200	206	208	207	190	181	162	148	136	130	124	117	113	109	96	79	69	64
157	165	170	176	182	196	211	219	224	222	203	190	164	147	136	125	118	112	105	102	93	72	63	57
165	172	177	185	193	226	234	245	250	242	216	197	165	143	130	122	114	108	99	97	90	62	46	37
140	150	171	206	233	255	270	290	317	277	241	216	170	139	120	111	105	99	96	93	85	61	42	30
116	139	166	230	262	299	324	355	371	310	263	230	176	142	112	104	96	91	99	93	75	55	34	21
95	120	144	215	255	323	413	443	486	371	312	261	199	138	114	90	95	90	85	77	62	51	31	17
85	115	134	189	279	365	506	541	570	414	323	264	190	146	123	102	84	79	74	64	52	35	23	15
84	107	132	153	281	373	493	524	535	382	290	227	157	85	50	59	58	55	50	45	29	19	16	13
111	106	66	104	187	304	491	521	549	390	295	223	154	78	39	28	24	22	20	20	15	14	12	11
27	33	49	84	146	252	479	515	521	377	282	216	140	75	35	26	20	18	17	15	14	11	11	10
25	29	38	64	113	218	392	485	499	332	250	185	131	74	33	24	20	17	15	13	11	10	9	8
21	24	30	49	82	142	257	326	371	264	201	155	110	64	31	24	19	15	14	11	9	9	7	6
18	21	26	36	59	100	160	223	278	211	157	130	89	56	29	23	19	15	13	10	8	7	6	5
15	17	20	27	39	63	101	142	185	141	111	95	65	43	26	21	17	14	11	9	7	6	6	5
14	15	17	21	29	45	68	95	145	108	88	70	39	28	22	18	15	13	9	7	6	5	5	4
11	12	13	15	21	31	44	63	85	70	56	43	28	22	20	17	14	10	8	6	5	4	3	2
8	8	8	9	10	12	13	20	28	20	14	14	12	10	9	10	11	7	7	4	3	3	2	1
3	3	3	4	4	5	4	6	10	8	5	4	4	2	2	2	2	2	2	2	2	2	2	2
2	2	2	2	2	3	3	5	8	5	3	3	2	2	1	1	1	1	2	1	0	1	0	0

245	250	255	260	265	270	275	280	285	290	295	300	305	310	315	320	325	330	335	340	345	350	355	360
214	214	214	214	214	214	214	214	214	214	214	214	214	213	213	212	213	213	213	213	211	213	212	213
214	214	214	214	215	215	215	214	214	214	214	214	215	216	216	217	217	217	217	218	218	219	218	219
210	209	209	209	210	210	210	209	209	209	210	211	212	212	211	213	213	214	214	217	215	218	217	219
204	205	205	205	203	203	203	205	205	205	204	204	204	205	204	204	206	208	209	211	213	215	216	217
195	198	198	198	196	196	196	198	198	198	195	195	195	196	197	199	201	205	209	213	218	221	224	226
184	186	186	186	187	187	187	186	186	186	184	185	187	189	192	198	205	209	218	221	226	228	232	235
175	177	177	178	179	179	179	178	177	177	175	176	179	184	192	200	206	212	217	223	229	233	237	241
167	167	167	167	169	169	169	167	167	167	167	170	175	183	192	197	205	211	219	224	232	238	244	248
159	157	156	156	160	160	160	156	156	157	159	164	171	180	188	195	201	207	216	221	228	235	242	246
153	147	144	143	148	148	148	143	144	147	153	159	166	175	183	189	196	202	208	215	224	230	238	245
144	135	131	130	138	139	138	130	131	135	144	152	160	169	176	182	188	194	201	209	218	226	235	243
135	123	118	117	125	126	125	117	118	123	135	143	151	160	168	173	178	185	192	198	205	214	224	234
126	112	107	106	114	115	114	106	107	112	126	135	143	150	158	162	168	173	177	184	191	200	209	219
115	105	101	100	107	108	107	100	101	105	115	123	131	140	146	151	155	158	163	172	177	185	196	208
111	103	99	97	101	101	101	97	99	103	111	117	123	128	134	140	143	146	153	158	164	173	183	197
106	99	96	94	96	96	96	94	96	99	106	110	114	118	125	130	133	139	141	148	155	165	175	190
100	95	92	90	89	89	89	90	92	95	100	103	105	106	115	119	125	130	135	141	147	156	166	183
84	85	83	81	78	77	78	81	83	85	84	88	94	102	104	113	119	124	129	133	141	153	165	182
63	73	74	73	67	66	67	73	74	73	63	64	69	79	96	109	113	117	124	130	136	148	162	181
55	62	62	60	53	52	53	60	62	62	55	57	63	72	93	102	105	112	118	125	136	147	164	190
34	46	48	47	41	40	41	47	48	46	34	37	46	62	90	97	99	108	114	122	130	143	165	197
25	35	36	35	30	29	30	35	36	35	25	30	42	61	85	93	96	99	105	111	120	139	170	216
15	24	24	23	18	17	18	23	24	24	15	21	34	55	75	93	99	91	96	104	112	142	176	230
10	17	16	15	13	13	13	15	16	17	10	17	31	51	62	77	85	90	95	90	114	138	199	261
11	14	13	13	12	12	12	13	13	14	11	15	23	35	52	64	74	79	84	102	123	146	190	264
11	12	11	11	10	10	10	11	11	12	11	13	16	19	29	45	50	55	58	59	50	85	157	227
10	11	10	9	7	7	7	9	10	11	10	11	12	14	15	20	20	22	24	28	39	78	154	223
9	6	5	4	4	4	4	4	5	6	9	10	11	11	14	15	17	18	20	26	35	75	140	216
7	5	4	3	1	1	1	3	4	5	7	8	9	10	11	13	15	17	20	24	33	74	131	185
5	3	2	1	1	1	1	1	2	3	5	6	7	9	9	11	14	15	19	24	31	64	110	155
4	3	2	2	2	2	2	2	2	3	4	5	6	7	8	10	13	15	19	23	29	56	89	130
4	3	2	2	2	2	2	2	2	3	4	5	6	6	7	9	11	14	17	21	26	43	65	95
3	3	2	2	1	1	1	2	2	3	3	4	5	5	6	7	9	13	15	18	22	28	39	70
1	1	1	1	0	0	0	1	1	1	1	2	3	4	5	6	8	10	14	17	20	22	28	43
0	0	0	0	0	0	0	0	0	0	0	1	2	3	3	4	7	7	11	10	9	10	12	14
2	0	0	0	0	0	0	0	0	0	2	2	2	2	2	2	2	2	2	2	2	2	4	4
0	0	0	0	0	0	0	0	0	0	0	0	0	1	0	1	2	1	1	1	1	2	2	3

ANNEXURE - II

Table-1(a): Computer output for single 150W HPSV source - Screen shot

```
MATLAB 7.7.0 (R2008b)
File Edit Debug Parallel Desktop Window Help
Current Directory: E:\THESIS
Shortcuts How to Add What's New

ILLUMINATION OF ROAD LIGHTING OF OPEN CAST MINES
ENTER THE SOURCE      1: conventional  2: LED          =1
ENTER THE NUMBER SOURCE      1: single source  2: double source      =1
ILLUMINATION OF ROAD LIGHTING WITH SINGLE SOURCE
ENTER THE TYPE OF SOURCES 1:CFL    2:FLUROCSENT  3:INCANDESCENT  4:METAL HALIDES  5: HIGH PRESSURE SODIUM VAPOUR:  = 5
HIGH PRESSURE SODIUM VAPOUR LAMP
SOURCE FITTED AT THE CENTER OF THE FIELD
TOTAL HEIGHT OF SOURCE FROM GROUND IN m=8
TOTAL WIDTH OF THE ROAD IN m=9
TOTAL LENGTH OF THE MEASURING FIELD IN m=9
ENTER 1: OVERHANGING  2: BEYOND KERB  3:ABOVE THE KERB  2
ENTER THE TILT ANGLE IN DEGREE =14
ENTER THE EXTENSION OF SOURCE IN m=2
enter 1: LUX DATA FOR VERTICAL ILLUMINATION1|
DISTANCE ALONG THE Z-PLANE

A =

    1.00

DISTANCE ALONG THE X-PLANE

B =

    1.00

A:B RATIO

RATIO =

    1.00

UTILIZATION FACTOR
```

```

MATLAB 7.7.0 (R2008b)
File Edit Debug Parallel Desktop Window Help
Current Directory: E:\THESIS
Shortcuts How to Add What's New

imf =

    1.20

HORIZONTAL ILLUMINATION FIELD ALONG THE ROAD WITH SOURCE AT THE CENTRE
    4.00    3.00    2.00    1.00    0    1.00    2.00    3.00    4.00    5.00    0
    3.95    4.84    5.67    6.26    6.47    6.26    5.67    4.84    3.95    3.11    1.00
    4.05    4.89    5.65    6.18    6.38    6.18    5.65    4.89    4.05    3.24    2.00
    3.86    4.58    5.22    5.66    5.82    5.66    5.22    4.58    3.86    3.15    3.00
    3.49    4.07    4.58    4.92    5.04    4.92    4.58    4.07    3.49    2.90    4.00
    3.04    3.49    3.88    4.13    4.23    4.13    3.88    3.49    3.04    2.57    5.00
    2.59    2.93    3.21    3.40    3.47    3.40    3.21    2.93    2.59    2.23    6.00
    2.17    2.42    2.63    2.76    2.81    2.76    2.63    2.42    2.17    1.90    7.00
    1.80    1.98    2.13    2.23    2.26    2.23    2.13    1.98    1.80    1.59    8.00
    1.49    1.62    1.73    1.80    1.82    1.80    1.73    1.62    1.49    1.33    9.00

HORIZONTAL ILLUMINATION MEAN
    3.54

VERTICAL ILLUMINATION FIELD ALONG THE ROAD WITH SOURCE AT THE CENTRE

z =

    4.00    3.00    2.00    1.00    0    1.00    2.00    3.00    4.00    5.00    0
    1.26    1.01    0.59    0.30    0.17    0.30    0.59    1.01    1.26    1.39    1.00
    1.35    1.14    0.88    0.59    0.54    0.59    0.88    1.14    1.35    1.45    2.00
    1.40    1.26    1.14    1.01    0.89    1.01    1.14    1.26    1.40    1.38    3.00
    1.41    1.40    1.35    1.26    1.26    1.26    1.35    1.40    1.41    1.36    4.00
    1.36    1.38    1.45    1.39    1.40    1.39    1.45    1.38    1.36    1.38    5.00
    1.34    1.38    1.38    1.43    1.44    1.43    1.38    1.38    1.34    1.27    6.00
    1.22    1.25    1.32    1.38    1.32    1.38    1.32    1.25    1.22    1.15    7.00
    1.08    1.17    1.17    1.22    1.23    1.22    1.17    1.17    1.08    1.03    8.00
    0.94    1.01    1.07    1.05    1.07    1.05    1.07    1.01    0.94    0.90    9.00

Start Waiting for input

```

Contd.

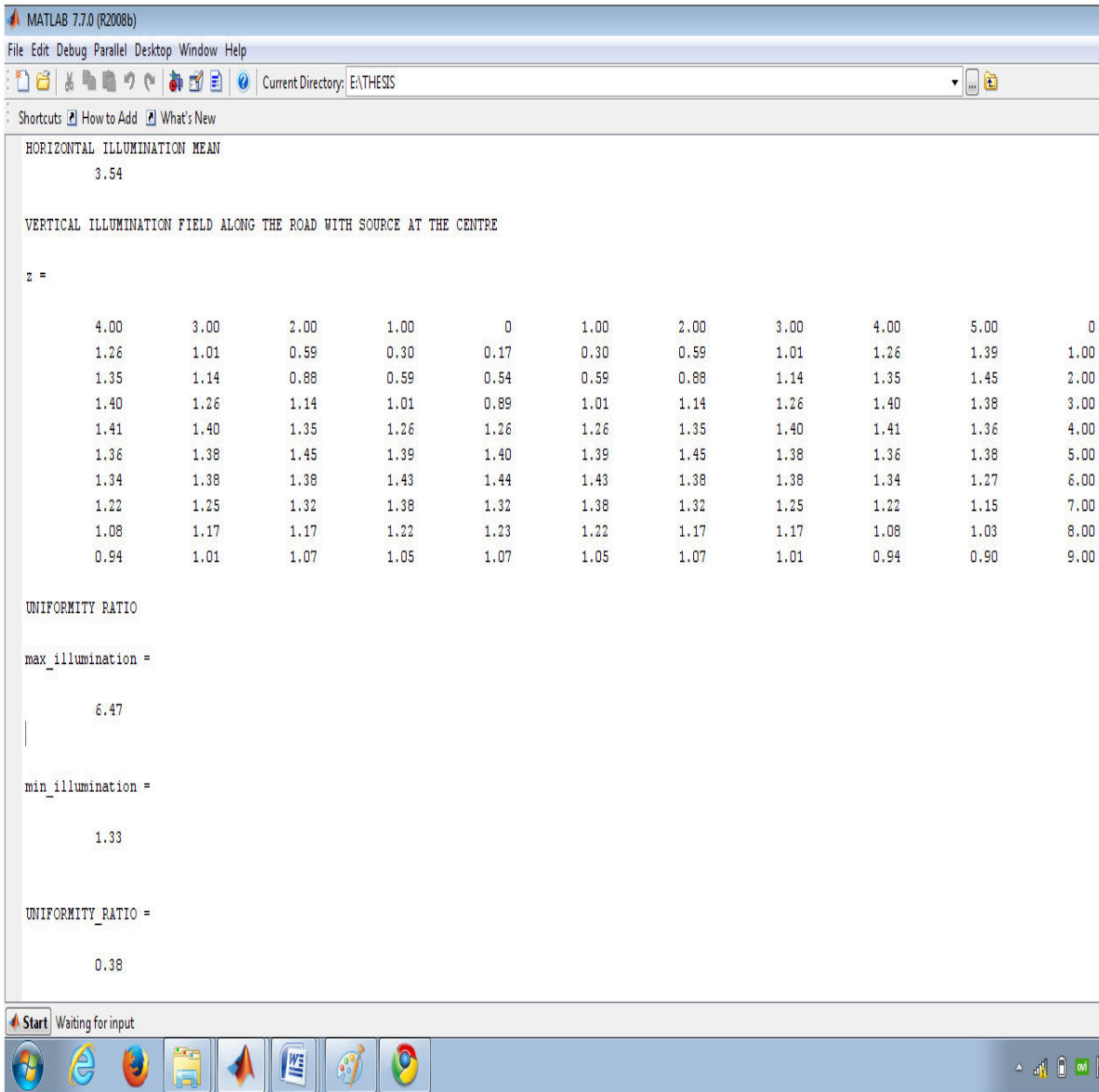

Table-1(b): Computer output for single 150W HPSV source.

ILLUMINATION OF ROAD LIGHTING OF OPEN CAST MINES
 ENTER THE SOURCE 1: conventional 2: LED =1
 ENTER THE NUMBER SOURCE 1: single source 2: double source =1
 ILLUMINATION OF ROAD LIGHTING WITH SINGLE SOURCE
 ENTER THE TYPE OF SOURCES 1:CFL 2:FLUROCSENT 3:INCANDESCENT
 4:METAL HALIDES 5: HIGH PRESSURE SODIUM VAPOUR: = 5

HIGH PRESSURE SODIUM VAPOUR LAMP
 SOURCE FITTED AT THE CENTER OF THE FIELD
 TOTAL HEIGHT OF SOURCE FROM GROUND IN m=8
 TOTAL WIDTH OF THE ROAD IN m=9
 TOTAL LENGTH OF THE MEASURING FIELD IN m=9
 ENTER 1: OVERHANGING 2: BEYOND KERB 3: ABOVE THE KERB 2
 ENTER THE TILT ANGLE IN DEGREE =14
 ENTER THE EXTENSION OF SOURCE IN m=2
 enter 1: LUX DATA FOR VERTICAL ILLUMINATION1
 DISTANCE ALONG THE Z-PLANE

A = 1.00

DISTANCE ALONG THE X-PLANE

B = 1.00

A:B RATIO

RATIO = 1.00

UTILIZATION FACTOR

uf = 0.95

INVERSE MAINTANANCE FACTOR

imf = 1.20

HORIZONTAL ILLUMINATION FIELD ALONG THE ROAD WITH SOURCE AT THE CENTRE

Columns 1 through 5

4.00	3.00	2.00	1.00	0
3.95	4.84	5.67	6.26	6.47
4.05	4.89	5.65	6.18	6.38
3.86	4.58	5.22	5.66	5.82
3.49	4.07	4.58	4.92	5.04
3.04	3.49	3.88	4.13	4.23
2.59	2.93	3.21	3.40	3.47
2.17	2.42	2.63	2.76	2.81
1.80	1.98	2.13	2.23	2.26
1.49	1.62	1.73	1.80	1.82

Columns 6 through 10

1.00	2.00	3.00	4.00	5.00
6.26	5.67	4.84	3.95	3.11
6.18	5.65	4.89	4.05	3.24
5.66	5.22	4.58	3.86	3.15
4.92	4.58	4.07	3.49	2.90
4.13	3.88	3.49	3.04	2.57
3.40	3.21	2.93	2.59	2.23
2.76	2.63	2.42	2.17	1.90
2.23	2.13	1.98	1.80	1.59
1.80	1.73	1.62	1.49	1.33

Column 11

0
1.00
2.00
3.00
4.00
5.00
6.00
7.00
8.00
9.00

HORIZONTAL ILLUMINATION MEAN

3.54

VERTICAL ILLUMINATION FIELD ALONG THE ROAD WITH SOURCE AT THE CENTRE

z =

Columns 1 through 5

4.00	3.00	2.00	1.00	0
1.26	1.01	0.59	0.30	0.17
1.35	1.14	0.88	0.59	0.54
1.40	1.26	1.14	1.01	0.89
1.41	1.40	1.35	1.26	1.26
1.36	1.38	1.45	1.39	1.40
1.34	1.38	1.38	1.43	1.44
1.22	1.25	1.32	1.38	1.32
1.08	1.17	1.17	1.22	1.23
0.94	1.01	1.07	1.05	1.07

Columns 6 through 10

1.00	2.00	3.00	4.00	5.00
0.30	0.59	1.01	1.26	1.39
0.59	0.88	1.14	1.35	1.45
1.01	1.14	1.26	1.40	1.38
1.26	1.35	1.40	1.41	1.36
1.39	1.45	1.38	1.36	1.38
1.43	1.38	1.38	1.34	1.27
1.38	1.32	1.25	1.22	1.15
1.22	1.17	1.17	1.08	1.03
1.05	1.07	1.01	0.94	0.90

Column 11

0
1.00
2.00
3.00
4.00
5.00
6.00
7.00
8.00
9.00

UNIFORMITY RATIO

max_illumination = 6.47

min_illumination = 1.33

UNIFORMITY_RATIO = 0.38

Table-2 (a): Computer output for two 150W HPSV sources - Screen shot

```
MATLAB 7.7.0 (R2008b)
File Edit Debug Parallel Desktop Window Help
Current Directory: E:\THESIS
Shortcuts How to Add What's New

ILLUMINATION OF ROAD LIGHTING OF OPEN CAST MINES
ENTER THE SOURCE      1: conventional  2: LED      =1
ENTER THE NUMBER SOURCE  1: single source  2: double source      =2
ILLUMINATION OF ROAD LIGHTING WITH DOUBLE SOURCE
enter 1:CFL  2:FLUROCSENT  3:INCANDESCENT  4:METAL HALIDES  5: HIGH PRESSURE SODIUM VAPOUR:  = 5
HIGH PRESSURE SODIUM VAPOUR LAMP
TWO SOURCE FITTED AT THE FIELD
TOTAL HEIGHT OF SOURCE FROM GROUND IN m=8
TOTAL WIDTH OF THE ROAD IN m=9
TOTAL LENGTH OF THE MEASURING FIELD IN m=9
ENTER 1: OVERHANGING  2: BEYOND KERB  3: ABOVE KERB  2
ENTER THE TILT ANGLE IN DEGREE  =14
ENTER THE EXTENSION OF SOURCE IN m=2
enter 1 : LUX DATA FOR VERTICAL ILLUMINATON :  1
DISTANCE ALONG THE Z-PLANE

A =

    1.00

DISTANCE ALONG THE X-PLANE

B =

    1.00

A:B RATIO

RATIO =

    1.00

UTILIZATION FACTOR
```



```

MATLAB 7.7.0 (R2008b)
File Edit Debug Parallel Desktop Window Help
Current Directory: E:\THESIS
Shortcuts How to Add What's New

A:B RATIO

RATIO =

    1.00

UTILIZATION FACTOR

uf =

    0.95

INVERSE MAINTANANCE FACTOR

imf =

    1.20

HORIZONTAL ILLUMINATION FIELD ALONG THE ROAD WITH TWO SOURCE

    0      1.00    2.00    3.00    4.00    5.00    6.00    7.00    8.00    0      0
14.95  15.20  14.93  14.45  14.11  14.11  14.45  14.93  15.20  14.95  1.00
14.99  15.32  15.18  14.84  14.58  14.58  14.84  15.18  15.32  14.99  2.00
13.97  14.35  14.35  14.17  14.01  14.01  14.17  14.35  14.35  13.97  3.00
12.40  12.79  12.90  12.85  12.78  12.78  12.85  12.90  12.79  12.40  4.00
10.66  11.04  11.21  11.25  11.24  11.24  11.25  11.21  11.04  10.66  5.00
 8.99   9.34   9.53   9.61   9.63   9.63   9.61   9.53   9.34   8.99   6.00
 7.49   7.80   7.99   8.09   8.13   8.13   8.09   7.99   7.80   7.49   7.00
 6.21   6.46   6.64   6.74   6.79   6.79   6.74   6.64   6.46   6.21   8.00
 5.13   5.35   5.50   5.59   5.64   5.64   5.59   5.50   5.35   5.13   9.00

HORIZONTAL ILLUMINATION MEAN

    9.56

```

Start | Waiting for input

```

MATLAB 7.7.0 (R2008b)
File Edit Debug Parallel Desktop Window Help
Current Directory: E:\THESIS
Shortcuts: How to Add What's New

HORIZONTAL ILLUMINATION MEAN
9.56

VERTICAL ILLUMINATION FIELD ALONG THE ROAD WITH TWO SOURCE

0 =

    0    1.00    2.00    3.00    4.00    5.00    6.00    7.00    8.00    0    0
  2.46    3.04    3.94    4.86    5.31    5.31    4.86    3.94    3.04    2.46    1.00
  3.24    3.54    4.39    5.04    5.61    5.61    5.04    4.39    3.54    3.24    2.00
  3.81    4.35    4.79    5.27    5.57    5.57    5.27    4.79    4.35    3.81    3.00
  4.40    4.68    5.14    5.50    5.55    5.55    5.50    5.14    4.68    4.40    4.00
  4.61    4.84    5.21    5.32    5.48    5.48    5.32    5.21    4.84    4.61    5.00
  4.50    4.77    4.89    5.12    5.24    5.24    5.12    4.89    4.77    4.50    6.00
  4.13    4.44    4.53    4.64    4.74    4.74    4.64    4.53    4.44    4.13    7.00
  3.83    3.96    4.03    4.25    4.21    4.21    4.25    4.03    3.96    3.83    8.00
  3.33    3.48    3.64    3.65    3.69    3.69    3.65    3.64    3.48    3.33    9.00

UNIFORMITY RATIO

max_illumination =

    15.32

min_illumination =

    5.13

UNIFORMITY_RATIO =

    0.54

Start | Waiting for input

```

Table-2 (b): Computer output for two 150W HPSV sources

ILLUMINATION OF ROAD LIGHTING OF OPEN CAST MINES

ENTER THE SOURCE 1: conventional 2: LED =1

ENTER THE NUMBER SOURCE 1: single source 2: double source =2

ILLUMINATION OF ROAD LIGHTING WITH DOUBLE SOURCE

enter 1:CFL 2:FLUROCSENT 3:INCANDESCENT 4:METAL HALIDES 5: HIGH PRESSURE SODIUM VAPOUR: = 5

HIGH PRESSURE SODIUM VAPOUR LAMP

TWO SOURCE FITTED AT THE FIELD

TOTAL HEIGHT OF SOURCE FROM GROUND IN m=8

TOTAL WIDTH OF THE ROAD IN m=9

TOTAL LENGTH OF THE MEASURING FIELD IN m=9

ENTER 1: OVERHANGING 2: BEYOND KERB 3: ABOVE KERB 2

ENTER THE TILT ANGLE IN DEGREE =14

ENTER THE EXTENSION OF SOURCE IN $m=2$
 enter 1 : LUX DATA FOR VERTICAL ILLUMINATION : 1
 DISTANCE ALONG THE Z-PLANE

A = 1.00

DISTANCE ALONG THE X-PLANE

B = 1.00

A:B RATIO

RATIO = 1.00

UTILIZATION FACTOR

uf = 0.95

INVERSE MAINTANANCE FACTOR

imf = 1.20

HORIZONTAL ILLUMINATION FIELD ALONG THE ROAD WITH TWO SOURCES

0	1.00	2.00	3.00	4.00	5.00	6.00	7.00	8.00	0	0
14.95	15.20	14.93	14.45	14.11	14.11	14.45	14.93	15.20	14.95	1.00
14.99	15.32	15.18	14.84	14.58	14.58	14.84	15.18	15.32	14.99	2.00
13.97	14.35	14.35	14.17	14.01	14.01	14.17	14.35	14.35	13.97	3.00
12.40	12.79	12.90	12.85	12.78	12.78	12.85	12.90	12.79	12.40	4.00
10.66	11.04	11.21	11.25	11.24	11.24	11.25	11.21	11.04	10.66	5.00
8.99	9.34	9.53	9.61	9.63	9.63	9.61	9.53	9.34	8.99	6.00
7.49	7.80	7.99	8.09	8.13	8.13	8.09	7.99	7.80	7.49	7.00
6.21	6.46	6.64	6.74	6.79	6.79	6.74	6.64	6.46	6.21	8.00
5.13	5.35	5.50	5.59	5.64	5.64	5.59	5.50	5.35	5.13	9.00

HORIZONTAL ILLUMINATION MEAN

9.56

VERTICAL ILLUMINATION FIELD ALONG THE ROAD WITH TWO SOURCE

O =

0	1.00	2.00	3.00	4.00	5.00	6.00	7.00	8.00	0	0
2.46	3.04	3.94	4.86	5.31	5.31	4.86	3.94	3.04	2.46	1.00
3.24	3.54	4.39	5.04	5.61	5.61	5.04	4.39	3.54	3.24	2.00
3.81	4.35	4.79	5.27	5.57	5.57	5.27	4.79	4.35	3.81	3.00
4.40	4.68	5.14	5.50	5.55	5.55	5.50	5.14	4.68	4.40	4.00
4.61	4.84	5.21	5.32	5.48	5.48	5.32	5.21	4.84	4.61	5.00
4.50	4.77	4.89	5.12	5.24	5.24	5.12	4.89	4.77	4.50	6.00
4.13	4.44	4.53	4.64	4.74	4.74	4.64	4.53	4.44	4.13	7.00
3.83	3.96	4.03	4.25	4.21	4.21	4.25	4.03	3.96	3.83	8.00
3.33	3.48	3.64	3.65	3.69	3.69	3.65	3.64	3.48	3.33	9.00

UNIFORMITY RATIO

max_illumination = 15.32

min_illumination = 5.13

UNIFORMITY_RATIO = 0.54

ANNEXURE - III

Table-1(a): Computer output for Total Annual Cost for 70W HPSV- Screen shot

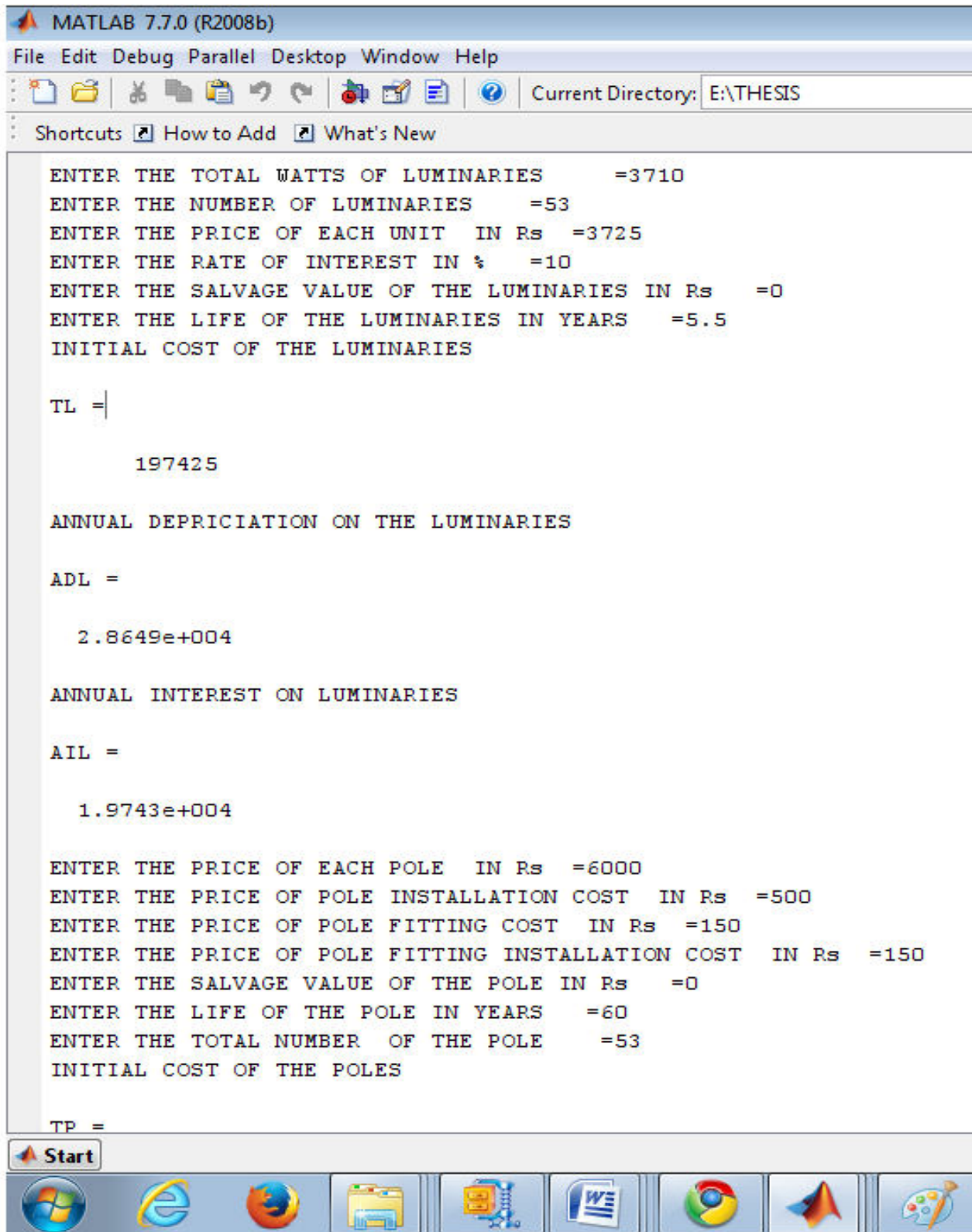

```
MATLAB 7.7.0 (R2008b)
File Edit Debug Parallel Desktop Window Help
Current Directory: E:\THESIS
Shortcuts How to Add What's New

ENTER THE TOTAL WATTS OF LUMINARIES      =3710
ENTER THE NUMBER OF LUMINARIES          =53
ENTER THE PRICE OF EACH UNIT IN Rs      =3725
ENTER THE RATE OF INTEREST IN %         =10
ENTER THE SALVAGE VALUE OF THE LUMINARIES IN Rs  =0
ENTER THE LIFE OF THE LUMINARIES IN YEARS  =5.5
INITIAL COST OF THE LUMINARIES

TL =

    197425

ANNUAL DEPRICIATION ON THE LUMINARIES

ADL =

    2.8649e+004

ANNUAL INTEREST ON LUMINARIES

AIL =

    1.9743e+004

ENTER THE PRICE OF EACH POLE IN Rs      =6000
ENTER THE PRICE OF POLE INSTALLATION COST IN Rs  =500
ENTER THE PRICE OF POLE FITTING COST IN Rs  =150
ENTER THE PRICE OF POLE FITTING INSTALLATION COST IN Rs  =150
ENTER THE SALVAGE VALUE OF THE POLE IN Rs  =0
ENTER THE LIFE OF THE POLE IN YEARS      =60
ENTER THE TOTAL NUMBER OF THE POLE      =53
INITIAL COST OF THE POLES

TP =
```

The image shows a MATLAB 7.7.0 (R2008b) window with a script being executed. The script calculates various financial metrics for poles and cables. The window title is 'MATLAB 7.7.0 (R2008b)'. The menu bar includes 'File', 'Edit', 'Debug', 'Parallel', 'Desktop', 'Window', and 'Help'. The toolbar shows standard file operations and a 'Current Directory' field set to 'E:\THE:'. The script content is as follows:

```

TP =

    360400

ANNUAL DEPRICIATION ON THE POLES

ADP =

    118.7551

ANNUAL INTEREST ON POLES

AIP =

    36040

ENTER THE PRICE OF CABLE IN Rs/Km =30000
ENTER THE TOTAL LENGTH OF THE CABLE IN Km =1
ENTER THE CABLE LAYING COST IN Rs/Km =20000
ENTER THE SALVAGE VALUE OF THE CABLE IN Rs =1500
ENTER THE LIFE OF THE CABLE IN YEARS =40
INITIAL COST OF THE CABLING

TC =

    50001

ANNUAL DEPRICIATION ON THE CABLE

ADC =

    109.5839

ANNUAL INTEREST ON CABLES

```

The window also shows the Windows taskbar at the bottom with the Start button and several application icons: Internet Explorer, Firefox, File Explorer, a calculator, Microsoft Word, and Google Chrome.

```

MATLAB 7.7.0 (R2008b)
File Edit Debug Parallel Desktop Window Help
Current Directory: E:\THESIS
Shortcuts How to Add What's New

ANNUAL INTEREST ON CABLES

AIC =

    5.0001e+003

ENTER THE PRICE OF EACH LAMP IN Rs =3725
ENTER THE NUMBER OF LAMP IN A PARTICULAR LUMINAIRE =1
ENTER THE NUMBER OF LAMPS IN A PARTICULAR TYPE =53
ENTER THE AVERAGE LAMP LIFE IN HOURS OF A PARTICULAR TYPE =24000
ENTER THE BURNING HOURS PER YEAR OF THE SWITCHING MODE =4380
ENTER THE KILOWATT-HOUR PRICE IN Rs =7.5
TOTAL WATTS PER LUMINAIRE OF A PARTICULAR TYPE =70
ENTER THE LABOUR COST PER LAMP REPLACEMENT =50
ENTER THE BALLAST LOSS OF LUMINAIRE IN WATTS =5
LAMP REPLACEMENT COST PER YEAR

LC =

    3.6030e+004

ENERGY COST PER YEAR

EN =

    1.3058e+005

LABOUR COST FOR LAMP REPLACEMENT

LCL =

    483.6250

ENTER THE MAINTANANCE COST PER LUMINARIES IN Rs =48

```

Start

Contd.

ENTER THE MAINTANANCE COST PER LUMINARIES IN Rs =48
ENTER THE NUMBER OF CLEANINGS PER YEAR =4
ENTER THE NUMBER OF LUMINARIES OF A PARTICULAR TYPE =53
MAINTANANCE COST PER YEAR

AMC =

10176

FIXED ANNUAL COST

FAC =

8.9660e+004

ANNUAL RUNNING COST

TOTAL ANNUAL COST OF LIGHTING SYSTEM

TAC =

2.6693e+005

fx >> |

Start



Table-1(b): Computer output for Total Annual Cost for 70W HPSV -MATLAB display

Parameter	Value
WATTAGE OF LAMP	70
SALVAGE VALUE OF LUMINARIES IN Rs	0
RATE OF INTEREST IN %	10
LIFE OF LUMINAIRE IN YEARS	5.5000
INITIAL COST OF LUMINARIES IN Rs	197425
NUMBER OF LUMINAIRES	53
PRICE OF EACH LUMINAIRE IN Rs	3725
SALVAGE VALUE OF POLE IN RS	0
LIFE OF POLE IN YEARS	60
INITIAL COST OF POLES	360400
UNIT POLE COST IN Rs	6000
UNIT POLE INSTALLATION COST IN Rs	500
UNIT POLE FITTINGS COST IN Rs	150
UNIT POLE FITTINGS INSTALLATION C...	150
TOTAL NUMBER OF POLES	53
SALVAGE VALUE OF CABLE IN Rs	1500
LIFE OF CABLE IN YEARS	40
INITIAL CABLING COST IN Rs	50001
CABLE COST IN RUPESS/Km	30000
TOTAL LENGTH OF CABLE IN Km	1
CABLE LAYING COST IN Rs/Km	20000
UNIT PRICE OF LAMP IN RS	3725
NUMBER OF LAMPS	1
ENTER THE NUMBER OF LAMPS IN A P...	53
AVERAGE LAMP LIFE IN HOURS OF A ...	24000
BURNING HOURS PER YEAR OF THE S...	4380
KILLOWATT-HOUR PRICE IN Rs	7.5000
TOTAL WATTS PER LUMINAIRE OF A P...	70
BALLAST LOSS /LUMINAIRE IN WATTS	5
MAINTANANCE COST PER LUMINAIRE I...	48
ENTER THE LABOUR COST PER LAMP ...	50
NUBER OF CLEANINGS PER ANNUM	4

NUMBER OF CLEANINGS PER ANNUM	4
ANNUAL DEPRICIATION ON LUMINAIRES	2.8649e+04
ANNUAL INTEREST ON LUMINAIRES	1.9743e+04
ANNUAL DEPRICIATION ON POLES	118.7551
ANNUAL INTERESTS ON POLES	36040
ANNUAL DEPRICIATION ON CABLE	109.5839
ANNUAL INTERESTS ON CABLE	5.0001e+03
LAMP REPLACEMENT COST PER YEAR	3.6030e+04
ENERGY COST PER YEAR	1.3058e+05
ANNUAL MAINTANACE COST PER YE...	10176
ANNUAL RUNNING COST PER YEAR	1.6709e+05
FIXED ANNUAL COST	8.9660e+04
TOTAL ANNUAL COST	2.6693e+05

Table-1(c): Computer output for Total Annual Cost for 70W HPSV

ENTER THE TOTAL WATTS OF LUMINARIES =3710
 ENTER THE NUMBER OF LUMINARIES =53
 ENTER THE PRICE OF EACH UNIT IN Rs =3725
 ENTER THE RATE OF INTEREST IN % =10
 ENTER THE SALVAGE VALUE OF THE LUMINARIES IN Rs =0
 ENTER THE LIFE OF THE LUMINARIES IN YEARS =5.5
 INITIAL COST OF THE LUMINARIES

TL = 197425

ANNUAL DEPRICIATION ON THE LUMINARIES

ADL = 2.8649e+004

ANNUAL INTEREST ON LUMINARIES

AIL = 1.9743e+004

ENTER THE PRICE OF EACH POLE IN Rs =6000

ENTER THE PRICE OF POLE INSTALLATION COST IN Rs =500

ENTER THE PRICE OF POLE FITTING COST IN Rs =150
ENTER THE PRICE OF POLE FITTING INSTALLATION COST IN Rs =150
ENTER THE SALVAGE VALUE OF THE POLE IN Rs =0
ENTER THE LIFE OF THE POLE IN YEARS =60
ENTER THE TOTAL NUMBER OF THE POLE =53
INITIAL COST OF THE POLES

$$TP = 360400$$

ANNUAL DEPRICIATION ON THE POLES

$$ADP = 118.7551$$

ANNUAL INTEREST ON POLES

$$AIP = 36040$$

ENTER THE PRICE OF CABLE IN Rs/Km =30000
ENTER THE TOTAL LENGTH OF THE CABLE IN Km =1
ENTER THE CABLE LAYING COST IN Rs/Km =20000
ENTER THE SALVAGE VALUE OF THE CABLE IN Rs =1500
ENTER THE LIFE OF THE CABLE IN YEARS =40
INITIAL COST OF THE CABLING

$$TC = 50001$$

ANNUAL DEPRICIATION ON THE CABLE

$$ADC = 109.5839$$

ANNUAL INTEREST ON CABLES

$$AIC = 5.0001e+003$$

ENTER THE PRICE OF EACH LAMP IN Rs =3725
ENTER THE NUMBER OF LAMP IN A PARTICULAR LUMINAIRE =1
ENTER THE NUMBER OF LAMPS IN A PARTICULAR TYPE =53
ENTER THE AVERAGE LAMP LIFE IN HOURS OF A PARTICULAR TYPE =24000
ENTER THE BURNING HOURS PER YEAR OF THE SWITCHING MODE =4380
ENTER THE KILOWATT-HOUR PRICE IN Rs =7.5
TOTAL WATTS PER LUMINAIRE OF A PARTICULAR TYPE =70
ENTER THE LABOUR COST PER LAMP REPLACEMENT =50
ENTER THE BALLAST LOSS OF LUMINAIRE IN WATTS =5
LAMP REPLACEMENT COST PER YEAR

$$LC = 3.6030e+004$$

ENERGY COST PER YEAR

$$EN = 1.3058e+005$$

LABOUR COST FOR LAMP REPLACEMENT

$$LCL = 483.6250$$

ENTER THE MAINTENANCE COST PER LUMINARIES IN Rs =48

ENTER THE NUMBER OF CLEANINGS PER YEAR =4

ENTER THE NUMBER OF LUMINARIES OF A PARTICULAR TYPE =53

MAINTENANCE COST PER YEAR

$$AMC = 10176$$

FIXED ANNUAL COST

$$FAC = 8.9660e+004$$

ANNUAL RUNNING COST

TOTAL ANNUAL COST OF LIGHTING SYSTEM

$$TAC = 2.6693e+005$$

>>

ANNEXURE - IV

Table-1: Computer program output for area lighting with 250W LED source

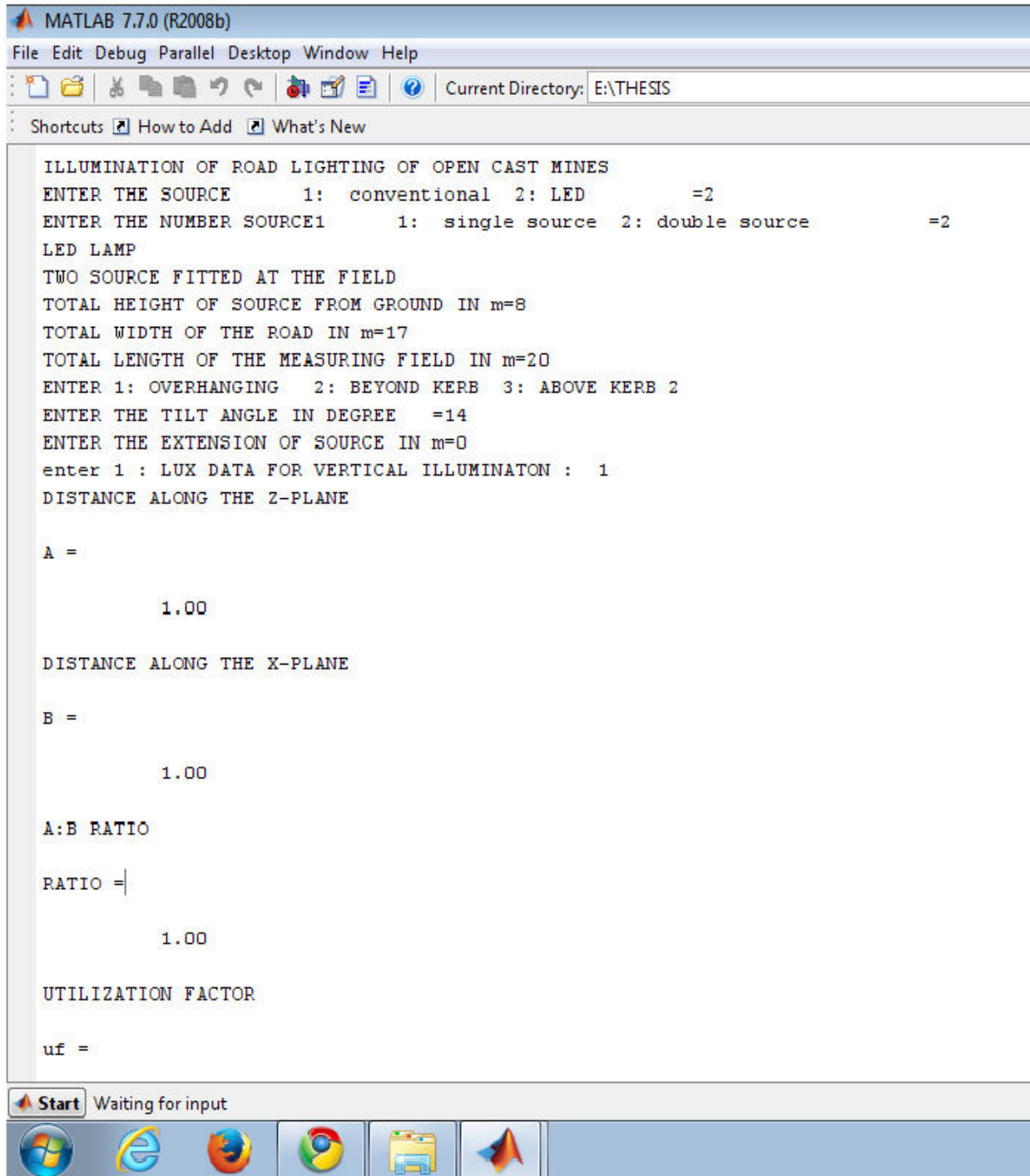

```
MATLAB 7.7.0 (R2008b)
File Edit Debug Parallel Desktop Window Help
Current Directory: E:\THESIS
Shortcuts How to Add What's New

ILLUMINATION OF ROAD LIGHTING OF OPEN CAST MINES
ENTER THE SOURCE      1: conventional  2: LED           =2
ENTER THE NUMBER SOURCE1      1: single source  2: double source      =2
LED LAMP
TWO SOURCE FITTED AT THE FIELD
TOTAL HEIGHT OF SOURCE FROM GROUND IN m=8
TOTAL WIDTH OF THE ROAD IN m=17
TOTAL LENGTH OF THE MEASURING FIELD IN m=20
ENTER 1: OVERHANGING  2: BEYOND KERB  3: ABOVE KERB  2
ENTER THE TILT ANGLE IN DEGREE      =14
ENTER THE EXTENSION OF SOURCE IN m=0
enter 1 : LUX DATA FOR VERTICAL ILLUMINATON :  1
DISTANCE ALONG THE Z-PLANE

A =

      1.00

DISTANCE ALONG THE X-PLANE

B =

      1.00

A:B RATIO

RATIO =|

      1.00

UTILIZATION FACTOR

uf =
```

MATLAB 7.7.0 (R2008b)

File Edit Debug Parallel Desktop Window Help

Current Directory: E:\THESIS

Shortcuts How to Add What's New

```

1.00

INVERSE MAINTANANCE FACTOR

imf =

1.10

HORIZONTAL ILLUMINATION FIELD ALONG THE ROAD WITH TWO SOURCE
Columns 1 through 11

    0    1.00    2.00    3.00    4.00    5.00    6.00    7.00    8.00    9.00   10.00
23.31  22.49  20.20  17.07  13.78  10.82    8.41    6.63    5.42    4.74    4.51
30.71  29.68  26.80  22.82  18.60  14.74  11.58    9.21    7.60    6.67    6.37
33.96  32.91  29.94  25.80  21.31  17.15  13.68  11.04    9.22    8.16    7.82
33.54  32.62  29.95  26.16  21.99  18.03  14.66  12.04  10.22    9.14    8.79
30.70  29.97  27.79  24.65  21.10  17.66  14.67  12.30  10.62    9.62    9.29
26.70  26.17  24.51  22.07  19.26  16.47  13.98  11.98  10.53    9.65    9.36
22.48  22.11  20.91  19.10  16.98  14.83  12.87  11.25  10.07    9.35    9.11
18.55  18.32  17.48  16.19  14.64  13.03  11.55  10.30    9.37    8.80    8.61
15.15  15.01  14.44  13.54  12.44  11.28  10.19    9.25    8.55    8.11    7.96
12.32  12.25  11.88  11.26  10.50    9.67    8.88    8.20    7.68    7.36    7.25
10.02  10.00    9.76    9.35    8.82    8.25    7.69    7.20    6.83    6.59    6.51
 8.18    8.18    8.04    7.77    7.41    7.02    6.63    6.29    6.02    5.85    5.79
 6.70    6.73    6.64    6.47    6.24    5.97    5.71    5.47    5.28    5.16    5.12
 5.53    5.56    5.52    5.42    5.26    5.09    4.91    4.74    4.62    4.53    4.50
 4.59    4.63    4.62    4.55    4.46    4.34    4.22    4.11    4.03    3.97    3.95
 3.84    3.88    3.88    3.85    3.79    3.72    3.64    3.57    3.51    3.47    3.46
 3.23    3.27    3.28    3.27    3.24    3.19    3.15    3.10    3.06    3.04    3.03

Columns 12 through 22

11.00  12.00  13.00  14.00  15.00  16.00  17.00  18.00  19.00    0    0
 4.74    5.42    6.63    8.41   10.82   13.78   17.07   20.20   22.49   23.31   1.00

```

Start Waiting for input

MATLAB 7.7.0 (R2008b)

File Edit Debug Parallel Desktop Window Help

Current Directory: E:\THESIS

Shortcuts How to Add What's New

Columns 12 through 22

11.00	12.00	13.00	14.00	15.00	16.00	17.00	18.00	19.00	0	0
4.74	5.42	6.63	8.41	10.82	13.78	17.07	20.20	22.49	23.31	1.00
6.67	7.60	9.21	11.58	14.74	18.60	22.82	26.80	29.68	30.71	2.00
8.16	9.22	11.04	13.68	17.15	21.31	25.80	29.94	32.91	33.96	3.00
9.14	10.22	12.04	14.66	18.03	21.99	26.16	29.95	32.62	33.54	4.00
9.62	10.62	12.30	14.67	17.66	21.10	24.65	27.79	29.97	30.70	5.00
9.65	10.53	11.98	13.98	16.47	19.26	22.07	24.51	26.17	26.70	6.00
9.35	10.07	11.25	12.87	14.83	16.98	19.10	20.91	22.11	22.48	7.00
8.80	9.37	10.30	11.55	13.03	14.64	16.19	17.48	18.32	18.55	8.00
8.11	8.55	9.25	10.19	11.28	12.44	13.54	14.44	15.01	15.15	9.00
7.36	7.68	8.20	8.88	9.67	10.50	11.26	11.88	12.25	12.32	10.00
6.59	6.83	7.20	7.69	8.25	8.82	9.35	9.76	10.00	10.02	11.00
5.85	6.02	6.29	6.63	7.02	7.41	7.77	8.04	8.18	8.18	12.00
5.16	5.28	5.47	5.71	5.97	6.24	6.47	6.64	6.73	6.70	13.00
4.53	4.62	4.74	4.91	5.09	5.26	5.42	5.52	5.56	5.53	14.00
3.97	4.03	4.11	4.22	4.34	4.46	4.55	4.62	4.63	4.59	15.00
3.47	3.51	3.57	3.64	3.72	3.79	3.85	3.88	3.88	3.84	16.00
3.04	3.06	3.10	3.15	3.19	3.24	3.27	3.28	3.27	3.23	17.00

HORIZONTAL ILLUMINATION MEAN

11.25

VERTICAL ILLUMINATION FIELD ALONG THE ROAD WITH TWO SOURCE

0 =

Columns 1 through 11

0	1.00	2.00	3.00	4.00	5.00	6.00	7.00	8.00	9.00	10.00
0.72	1.03	1.68	2.60	3.19	3.61	3.81	3.87	3.81	3.72	3.79
1.46	1.61	2.22	2.86	3.37	3.71	3.69	3.76	3.69	3.71	3.68
2.13	2.43	2.77	3.07	3.48	3.54	3.66	3.60	3.62	3.53	3.50

Start Waiting for input

MATLAB 7.7.0 (R2008b)

File Edit Debug Parallel Desktop Window Help

Current Directory: E:\THESIS

Shortcuts How to Add What's New

54.08	56.40	58.47	60.32	61.98	63.48	64.84	66.07	67.19	68.22
54.41	56.67	58.69	60.50	62.14	63.61	64.95	66.17	67.28	68.30
54.94	57.11	59.05	60.81	62.39	63.83	65.14	66.33	67.42	68.42
55.65	57.69	59.54	61.21	62.74	64.12	65.39	66.55	67.61	68.58
56.49	58.39	60.13	61.71	63.16	64.49	65.70	66.82	67.84	68.79
57.44	59.19	60.81	62.29	63.66	64.91	66.07	67.14	68.12	69.04
58.47	60.06	61.55	62.93	64.21	65.39	66.48	67.50	68.44	69.32
59.54	60.98	62.34	63.61	64.80	65.91	66.94	67.90	68.79	69.63
60.63	61.93	63.16	64.33	65.42	66.45	67.42	68.32	69.17	69.96
61.71	62.88	64.00	65.06	66.07	67.02	67.92	68.77	69.56	70.31
62.79	63.83	64.84	65.80	66.73	67.61	68.44	69.23	69.98	70.69
63.83	64.76	65.67	66.55	67.39	68.20	68.97	69.71	70.40	71.07
64.84	65.67	66.48	67.28	68.05	68.79	69.50	70.19	70.84	71.46
65.80	66.55	67.28	68.00	68.70	69.38	70.04	70.67	71.27	71.86
66.73	67.39	68.05	68.70	69.34	69.96	70.56	71.15	71.71	72.26
67.61	68.20	68.79	69.38	69.96	70.53	71.08	71.62	72.15	72.65
68.44	68.97	69.50	70.04	70.56	71.08	71.59	72.09	72.58	73.05

UNIFORMITY RATIO

max_illumination =

33.96

min_illumination =

3.03

UNIFORMITY_RATIO =

0.27

Start | Waiting for input

ANNEXURE V

1. Statistical analysis

The statistical analysis has been carried out to predict the accuracy of computed values with respect to measured values using following statistical analysis using the below mentioned equations of (1.1 to 1.5) (John et al., 2011; Sarkar et al., 2016).

The Mean Percentage Error (MPE) is also known as Mean Absolute Relative Error (MARE), is a measure of accuracy of computed value w.r.t. measured value, in percentage as shown in Equation (1.1)

$$MPE = \frac{1}{n} \sum_{i=1}^n \frac{(R_F - R_M)}{R_F} * 100 \quad (1.1)$$

where,

R_M = Reading of predicted/computed output, lux

R_F = Reading of practical/field measured values, lux, and

n = No. of samples of practical/field measured readings.

The Mean Bias Error (MBE) is a measure of overall bias error or systematic error. MBE is usually written as percentage error (multiply MBE by 100%) as shown in Equation (1.2)

$$MBE = \frac{1}{n} \sum_{i=1}^n (R_F - R_M) \quad (1.2)$$

where,

R_M = Reading of predicted/computed output, lux

R_F = Reading of practical/field measured values, lux, and

n = No. of samples of practical/field measured readings.

Root Mean Square Error (RMSE) is a measure of average deviation from the true value as shown in Equation (1.3)

$$RMSE = \sqrt{\frac{1}{n} \sum_{i=1}^n (R_F - R_M)^2} \quad (1.3)$$

where,

R_M = Reading of predicted/computed output, lux

R_F = Reading of practical/field measured values, lux, and

n = No. of samples of practical/field measured readings.

The coefficient of determination (denoted by R^2) is a key output of regression [a measure of the relation between the mean value of one variable (such as computed value) and corresponding values of other variables (such as field measured values)] analysis. It is interpreted as the proportion of the variance in the dependent variable that is predictable from the independent variable. An R^2 between 0 and 1 indicates the extent to which the dependent variable is predictable as shown in Equation (1.4).

$$R^2 = 1 - \frac{\sum_{i=1}^n (R_F - R_M)^2}{\sum_{i=1}^n (R_F - R_{Favg})^2} \quad (1.4)$$

where,

R_M = Reading of predicted/computed output, lux

R_F = Reading of practical/field measured values, lux

n = No. of samples of practical/field measured readings, and

R_{Favg} = Average value of field measured values, lux.

The t statistic (t_{-stat}) is a measure of how extreme a statistical estimate is as shown in Equation (1.5).

$$t_{(-stat)} = \sqrt{\frac{(n-1)MBE^2}{RMSE^2 - MBE^2}} \quad (1.5)$$

where,

MBE = mean bias error,

n = No. of samples of practical field measured readings, and

RMSE = root mean square error.

1.1 Statistical analysis for single 150W HPSV source

The Table 1(a) and Table 1(b) gives the horizontal and vertical lux levels, respectively for single 150W HPSV source, as obtained in Figures 4.5, 4.6 and 4.7. The measured values are represented as ' R_F ' whereas computed values are represented as ' R_M '.

For determining error in each set of values (both horizontal and vertical lux levels) along every grid line i.e. at 0 grid (along axis of the pole) and on both side (i.e. on left and right side) of the pole axis, statistical analysis was done and the results were given in Tables 2(a&b), 3(a&b), 4(a&b), 5(a&b), 6(a&b), 7(a&b), 8(a&b), 9(a&b), 10(a&b) and 11(a&b), and their respective MPE, MBE, RMSE, R^2 and $t_{(-stat)}$ were calculated.

Table 1(a): Computed (R_M) and measured (R_F) horizontal lux levels for single 150W HPSV source

Illuminance level, Lux																			
4m		3m		2m		1m		0m		1m		2m		3m		4m		5m	
R_M	R_F	R_M	R_F	R_M	R_F	R_M	R_F	R_M	R_F	R_M	R_F	R_M	R_F	R_M	R_F	R_M	R_F	R_M	R_F
3.95	3.82	4.84	4.73	5.67	5.56	6.26	6.2	6.47	6.19	6.26	6.21	5.67	5.58	4.84	4.75	3.95	3.84	3.11	3.1
4.05	3.97	4.89	4.76	5.65	5.51	6.18	6.13	6.38	6.12	6.18	6.15	5.65	5.53	4.89	4.78	4.05	3.99	3.24	3.22
3.86	3.82	4.58	4.48	5.22	5.12	5.66	5.52	5.82	5.58	5.66	5.51	5.22	5.13	4.58	4.49	3.86	3.88	3.15	3.11
3.49	3.36	4.07	4.04	4.58	4.48	4.92	4.9	5.04	4.88	4.92	4.91	4.58	4.49	4.07	4.05	3.49	3.38	2.9	2.87
3.04	3	3.49	3.45	3.88	3.79	4.13	4.06	4.23	4.12	4.13	4.08	3.88	3.77	3.49	3.47	3.04	3.01	2.57	2.51
2.59	2.52	2.93	2.81	3.21	3.2	3.4	3.35	3.47	3.32	3.4	3.35	3.21	3.23	2.93	2.83	2.59	2.55	2.23	2.16
2.17	2.11	2.42	2.35	2.63	2.59	2.76	2.62	2.81	2.72	2.76	2.64	2.63	2.58	2.42	2.37	2.17	2.14	1.9	1.83
1.8	1.72	1.98	1.85	2.13	2.11	2.23	2.18	2.26	2.2	2.23	2.19	2.13	2.14	1.98	1.88	1.8	1.74	1.59	1.51
1.49	1.42	1.62	1.45	1.73	1.62	1.8	1.72	1.82	1.78	1.8	1.74	1.73	1.65	1.62	1.46	1.49	1.45	1.33	1.29

Table-1(b): Computed (R_M) and measured (R_F) vertical lux levels for single 150W HPSV source

Illuminance level, Lux																			
4m		3m		2m		1m		0m		1m		2m		3m		4m		5m	
R_M	R_F	R_M	R_F	R_M	R_F	R_M	R_F	R_M	R_F	R_M	R_F	R_M	R_F	R_M	R_F	R_M	R_F	R_M	R_F
1.26	1.21	1.01	1	0.59	0.52	0.3	0.29	0.17	0.11	0.3	0.3	0.59	0.54	1.01	1.02	1.26	1.23	1.39	1.32
1.35	1.32	1.14	1.1	0.88	0.83	0.55	0.52	0.54	0.5	0.59	0.52	0.88	0.85	1.14	1.11	1.35	1.34	1.45	1.42
1.4	1.37	1.26	1.22	1.14	1.11	1.01	0.99	0.89	0.8	1.01	0.97	1.14	1.13	1.26	1.24	1.4	1.38	1.38	1.36
1.41	1.39	1.4	1.37	1.35	1.24	1.26	1.18	1.26	1.21	1.26	1.19	1.35	1.26	1.4	1.39	1.41	1.37	1.36	1.32
1.36	1.32	1.38	1.36	1.45	1.37	1.39	1.26	1.4	1.34	1.39	1.29	1.45	1.39	1.38	1.39	1.36	1.34	1.38	1.33
1.34	1.31	1.38	1.37	1.38	1.29	1.03	1.4	1.44	1.32	1.43	1.41	1.38	1.28	1.38	1.39	1.34	1.33	1.27	1.22
1.22	1.17	1.25	1.21	1.32	1.27	1.38	1.31	1.32	1.28	1.38	1.33	1.32	1.29	1.25	1.23	1.22	1.19	1.15	1.12
1.08	1.02	1.17	1.13	1.17	1.11	1.22	1.2	1.23	1.17	1.22	1.2	1.17	1.13	1.17	1.14	1.08	1.03	1.03	1.01
0.94	0.91	1.01	1	1.07	1.02	1.05	1	1.07	1	1.05	1	1.07	1.05	1.01	1	0.94	0.9	0.9	0.88

Table-2(a): Error analysis along 0m grid for single 150W HPSV source (for horizontal lux measurements)

No.	R_M	R_F	$R_F - R_M$	$(R_F - R_M)^2$	$(R_F - R_M) / R_F$	$R_F - R_{F(avg)}$	$(R_F - R_{F(avg)})^2$
1	6.47	6.19	-0.28	0.0784	-0.0452	2.089	4.3639
2	6.38	6.12	-0.26	0.0676	-0.0425	2.019	4.0764
3	5.82	5.58	-0.24	0.0576	-0.043	1.479	2.1874
4	5.04	4.88	-0.16	0.0256	-0.0328	0.779	0.6068
5	4.23	4.12	-0.11	0.0121	-0.0267	0.019	0.0004
6	3.47	3.32	-0.15	0.0225	-0.0452	-0.781	0.61
7	2.81	2.72	-0.09	0.0081	-0.0331	-1.381	1.9072
8	2.26	2.2	-0.06	0.0036	-0.0273	-1.901	3.6138
9	1.82	1.78	-0.04	0.0016	-0.0225	-2.321	5.387
Sum	-	36.91	-1.39	0.2771	-0.3182	0.001	22.753
Average	-	4.101	-0.15444	0.03079	-0.0354	-	-

From Equation (1), MPE = - 3.54

From Equation (2), MBE = - 0.1544

From Equation (3), RMSE = 0.175

From Equation (4), $R^2 = 0.9878$

From Equation (5), $t_{(-stat)} = 5.247$

Table 2(b): Error analysis along 0m grid for single 150W HPSV source (for vertical lux measurements)

Sl No.	R_M	R_F	$R_F - R_M$	$(R_F - R_M)^2$	$(R_F - R_M) / R_F$	$R_F - R_{F(avg)}$	$(R_F - R_{F(avg)})^2$
1	0.17	0.11	-0.06	0.0036	-0.5454545	-0.86	0.7396
2	0.54	0.5	-0.04	0.0016	-0.08	-0.47	0.2209
3	0.89	0.8	-0.09	0.0081	-0.1125	-0.17	0.0289
4	1.26	1.21	-0.05	0.0025	-0.0413223	0.24	0.0576
5	1.4	1.34	-0.06	0.0036	-0.0447761	0.37	0.1369
6	1.44	1.32	-0.12	0.0144	-0.0909091	0.35	0.1225
7	1.32	1.28	-0.04	0.0016	-0.03125	0.31	0.0961
8	1.23	1.17	-0.06	0.0036	-0.0512821	0.2	0.04
9	1.07	1	-0.07	0.0049	-0.07	0.03	0.0009
Sum	-	8.73	-0.59	0.0439	-1.0674941	-	-
Average	-	0.97	-0.0656	0.004878	-0.11861	-	-

From Equation (1), MPE = - 11.86

From Equation (2), MBE = - 0.065

From Equation (3), RMSE = 0.0698

From Equation (4), $R^2 = 0.9695$

From Equation (5), $t_{(-stat)} = 7.76$

Table-3(a) Error analysis along 1m grid (left side) for single 150W HPSV source (for horizontal lux measurements)

SI No.	R_M	R_F	$R_F - R_M$	$(R_F - R_M)^2$	$(R_F - R_M) / R_F$	$R_F - R_{F(avg)}$	$(R_F - R_{F(avg)})^2$
1	6.26	6.2	-0.06	0.0036	-0.0096774	2.12	4.4944
2	6.18	6.13	-0.05	0.0025	-0.0081566	2.05	4.2025
3	5.66	5.52	-0.14	0.0196	-0.0253623	1.44	2.0736
4	4.92	4.9	-0.02	0.0004	-0.0040816	0.82	0.6724
5	4.13	4.06	-0.07	0.0049	-0.0172414	-0.02	0.0004
6	3.4	3.35	-0.05	0.0025	-0.0149254	-0.73	0.5329
7	2.76	2.62	-0.14	0.0196	-0.0534351	-1.46	2.1316
8	2.23	2.18	-0.05	0.0025	-0.0229358	-1.9	3.61
9	1.8	1.72	-0.08	0.0064	0.0465116	-2.36	5.5696
Sum	-	36.68	-0.66	0.062	0.2023273	-0.04	23.2874
Average	-	4.076	-0.0733	0.00688	0.0224	-	-

From Equation (1), MPE = - 2.24

From Equation (2), MBE = - 0.0733

From Equation (3), RMSE = 0.082

From Equation (4), $R^2 = 0.976$

From Equation (5), $t_{(-stat)} = 5.64$

Table-3(b): Error analysis along 1m grid (left side) for single 150W HPSV source (for vertical lux measurements)

SI No.	R_M	R_F	$R_F - R_M$	$(R_F - R_M)^2$	$(R_F - R_M) / R_F$	$R_F - R_{F(avg)}$	$(R_F - R_{F(avg)})^2$
1	0.3	0.29	-0.01	0.0001	-0.034482759	-0.726	0.527076
2	0.55	0.52	-0.03	0.0009	-0.057692308	-0.496	0.246016
3	1.01	0.99	-0.02	0.0004	-0.02020202	-0.026	0.000676
4	1.26	1.18	-0.08	0.0064	-0.06779661	0.164	0.026896
5	1.39	1.26	-0.13	0.0169	-0.103174603	0.244	0.059536
6	1.03	1.4	0.37	0.1369	0.26428571	0.384	0.147456
7	1.38	1.31	-0.07	0.0049	-0.053435115	0.294	0.086436
8	1.22	1.2	-0.02	0.0004	-0.016666667	0.184	0.033856
9	1.05	1	-0.05	0.0025	-0.05	-0.016	0.000256
Sum	-	9.15	-0.04	0.1694	-0.139164367	0.006	1.128204
Average	-	1.016	-0.00666	0.0188	-0.0154627	-	-

From Equation (1), MPE = - 1.54627

From Equation (2), MBE = - 0.00666

From Equation (3), RMSE = 0.1371

From Equation (4), $R^2 = 0.85$

From Equation (5), $t_{(-stat)} = 0.137$

Table-4(a): Error analysis along 1m grid (right side) for single 150W HPSV source (for horizontal lux measurements)

Sl No.	R_M	R_F	$R_F - R_M$	$(R_F - R_M)^2$	$(R_F - R_M) / R_F$	$R_F - R_{F(avg)}$	$(R_F - R_{F(avg)})^2$
1	6.26	6.21	-0.05	0.0025	-0.0080515	2.124	4.511376
2	6.18	6.15	-0.03	0.0009	-0.004878	2.064	4.260096
3	5.66	5.51	-0.15	0.0225	-0.0272232	1.424	2.027776
4	4.92	4.91	-0.01	1E-04	-0.0020367	0.824	0.678976
5	4.13	4.08	-0.05	0.0025	-0.0122549	-0.006	0.00003.6
6	3.4	3.35	-0.05	0.0025	-0.0149254	-0.736	0.541696
7	2.76	2.64	-0.12	0.0144	-0.0454545	-1.446	2.090916
8	2.23	2.19	-0.04	0.0016	-0.0182648	-1.896	3.594816
9	1.8	1.74	-0.06	0.0036	-0.0344828	-2.346	5.503716
Sum	-	36.78	-0.56	0.3136	-0.1675719	0.006	23.2094
Average	-	4.086	-0.0622	0.00562	-0.01861	-	-

From Equation (1), MPE = -1.861

From Equation (2), MBE = - 0.06222

From Equation (3), RMSE = 0.07496

From Equation (4), $R^2 = 0.9978$

From Equation (5), $t_{(-stat)} = 16.85$

Table-4(b): Error analysis along 1m grid (right side) for single 150W HPSV source (for vertical lux measurements)

Sl No.	R_M	R_F	$R_F - R_M$	$(R_F - R_M)^2$	$(R_F - R_M) / R_F$	$R_F - R_{F(avg)}$	$(R_F - R_{F(avg)})^2$
1	0.3	0.3	0	0	-0	-0.727	0.528529
2	0.59	0.52	-0.07	0.0049	-0.00125	-0.507	0.257049
3	1.01	0.97	-0.04	0.0016	-0.000714286	-0.057	0.003249
4	1.26	1.19	-0.07	0.0049	-0.00125	0.163	0.026569
5	1.39	1.29	-0.1	0.01	-0.001785714	0.263	0.069169
6	1.43	1.41	-0.02	0.0004	-0.000357143	0.383	0.146689
7	1.38	1.33	-0.05	0.0025	-0.000892857	0.303	0.091809

Contd.

8	1.22	1.22	0	0	0	0.193	0.037249
9	1.05	1	-0.05	0.0025	-0.000892857	-0.027	0.000729
Sum	-	9.23	-0.4	0.0268	-0.007142857	8.203	67.289209
Average	-	1.027	-0.04444	0.0029	-0.00075	-	-

From Equation (1), MPE = - 0.075

From Equation (2), MBE = - 0.04444

From Equation (3), RMSE = 0.0538

From Equation (4), $R^2 = 0.999$

From Equation (5), $t_{(-stat)} = 19.61$

Table-5(a): Error analysis along 2m grid (left side) for single 150W HPSV source (for horizontal lux measurements)

Sl No.	R_M	R_F	$R_F - R_M$	$(R_F - R_M)^2$	$(R_F - R_M) / R_F$	$R_F - R_{F(avg)}$	$(R_F - R_{F(avg)})^2$
1	5.67	5.56	-0.11	0.0121	-0.0197842	-3.218	10.35552
2	5.65	5.51	-0.14	0.0196	-0.0254083	-3.268	10.67982
3	5.22	5.12	-0.1	0.01	-0.0195312	-3.658	13.38096
4	4.58	4.48	-0.1	0.01	-0.0223214	-4.298	18.4728
5	3.88	3.79	-0.09	0.0081	-0.0237467	-4.988	24.88014
6	3.21	3.2	-0.01	0.0001	-0.003125	-5.578	31.11408
7	2.63	2.59	-0.04	0.0016	-0.015444	-6.188	38.29134
8	2.13	2.11	-0.02	0.0004	-0.0094787	-6.668	44.46222
9	1.73	1.62	-0.11	0.0121	-0.0679012	-7.158	51.23696
Sum	-	33.98	-0.72	0.074	-0.2067408	25.202	242.8739
Average	-	8.778	-0.08	0.008222	-0.0229712	-	-

From Equation (1), MPE = - 2.297

From Equation (2), MBE = - 0.00822

From Equation (3), RMSE = 0.0966

From Equation (4), $R^2 = 0.9985$

From Equation (5), $t_{(-stat)} = 8.0663$

Table-5(b): Error analysis along 2m grid (left side) for single 150W HPSV source (for vertical lux measurements)

SI No.	R_M	R_F	$R_F - R_M$	$(R_F - R_M)^2$	$(R_F - R_M) / R_F$	$R_F - R_{F(avg)}$	$(R_F - R_{F(avg)})^2$
1	0.59	0.52	-0.07	0.0049	-0.134615385	-0.5644	0.31854736
2	0.88	0.83	-0.05	0.0025	-0.060240964	-0.2544	0.06471936
3	1.14	1.11	-0.03	0.0009	-0.027027027	0.0256	0.00065536
4	1.35	1.24	-0.11	0.0121	-0.088709677	0.1556	0.02421136
5	1.45	1.37	-0.08	0.0064	-0.058394161	0.2856	0.08156736
6	1.38	1.29	-0.09	0.0081	-0.069767442	0.2056	0.04227136
7	1.32	1.27	-0.05	0.0025	-0.039370079	0.1856	0.03444736
8	1.17	1.11	-0.06	0.0036	-0.054054054	0.0256	0.00065536
9	1.07	1.02	-0.05	0.0025	-0.049019608	-0.0644	0.00414736
Sum	-	9.76	-0.59	0.0435	-0.581198396	0.0004	0.57122224
Average	-	1.0844	-0.065555	0.0048334	-0.06457	-	-

From Equation (1), MPE = - 6.04

From Equation (2), MBE = - 0.065555

From Equation (3), RMSE = 0.208

From Equation (4), $R^2 = 0.9581$

From Equation (5), $t_{(-stat)} = 0.936$

Table-6(a): Error analysis along 2m grid (right side) for single 150W HPSV source (for horizontal lux measurements)

SI No.	R_M	R_F	$R_F - R_M$	$(R_F - R_M)^2$	$(R_F - R_M) / R_F$	$R_F - R_{F(avg)}$	$(R_F - R_{F(avg)})^2$
1	5.67	5.58	-0.09	0.0081	-0.016129	1.7912	3.208397
2	5.65	5.53	-0.12	0.0144	-0.0216998	1.7412	3.031777
3	5.22	5.13	-0.09	0.0081	-0.0175439	1.3412	1.798817
4	4.58	4.49	-0.09	0.0081	-0.0200445	0.7012	0.491681
5	3.88	3.77	-0.11	0.0121	-0.0291777	-0.0188	0.000353
6	3.21	3.23	0.02	0.0004	0.006192	-0.5588	0.312257
7	2.63	2.58	-0.05	0.0025	-0.0193798	-1.2088	1.461197
8	2.13	2.14	0.01	0.0001	0.004673	-1.6488	2.718541
9	1.73	1.65	-0.08	0.0064	-0.0484848	-2.1388	4.574465
Sum	-	34.1	-0.6	0.0602	-0.1615948	0.0008	17.59749
Average	-	3.789	-0.0666	0.006688	--0.017955	-	-

From Equation (1), MPE = -1.79

From Equation (2), MBE = - 0.0666

From Equation (3), RMSE= 0.08178

From Equation (4), $R^2 = 0.9965$

From Equation (5), $t_{(-stat)} = 15.37$

Table-6(b): Error analysis along 2m grid (right side) for single 150W HPSV source (for vertical lux measurements)

SI No.	R_M	R_F	$R_F - R_M$	$(R_F - R_M)^2$	$(R_F - R_M) / R_F$	$R_F - R_{F(avg)}$	$(R_F - R_{F(avg)})^2$
1	0.59	0.54	-0.05	0.0025	-0.092592593	-0.5622	0.31606884
2	0.88	0.85	-0.03	0.0009	-0.035294118	-0.2522	0.06360484
3	1.14	1.13	-0.01	0.0001	-0.008849558	0.0278	0.00077284
4	1.35	1.26	-0.09	0.0081	-0.071428571	0.1578	0.02490084
5	1.45	1.39	-0.06	0.0036	-0.043165468	0.2878	0.08282884
6	1.38	1.28	-0.1	0.01	-0.078125	0.1778	0.03161284
7	1.32	1.29	-0.03	0.0009	-0.023255814	0.1878	0.03526884
8	1.17	1.13	-0.04	0.0016	-0.03539823	0.0278	0.00077284
9	1.07	1.05	-0.02	0.0004	-0.019047619	-0.0522	0.00272484
Sum	-	9.92	-0.43	0.0281	-0.40715697	0.0002	0.55855556
Average	-	1.1022	-0.04777	0.003122	-0.04524	-	-

From Equation (1), $MPE = -4.524$

From Equation (2), $MBE = -0.04777$

From Equation (3), $RMSE = 0.05585$

From Equation (4), $R^2 = 0.9496$

From Equation (5), $t_{(-stat)} = 4.6695$

Table-7(a): Error analysis along 3m grid (left side) for single 150W HPSV source (for horizontal lux measurements)

SI No.	R_M	R_F	$R_F - R_M$	$(R_F - R_M)^2$	$(R_F - R_M) / R_F$	$R_F - R_{F(avg)}$	$(R_F - R_{F(avg)})^2$
1	4.84	4.73	-0.11	0.0121	-0.0232558	1.4056	1.975711
2	4.89	4.76	-0.13	0.0169	-0.0273109	1.4356	2.060947
3	4.58	4.48	-0.1	0.01	-0.0223214	1.1556	1.335411
4	4.07	4.04	-0.03	0.0009	-0.0074257	0.7156	0.512083
5	3.49	3.45	-0.04	0.0016	-0.0115942	0.1256	0.015775
6	2.93	2.81	-0.12	0.0144	-0.0427046	-0.5144	0.264607
7	2.42	2.35	-0.07	0.0049	-0.0297872	-0.9744	0.949455
8	1.98	1.85	-0.13	0.0169	-0.0702703	-1.4744	2.173855
9	1.62	1.45	-0.17	0.0289	-0.1172414	-1.8744	3.513375
Sum	-	29.92	-0.9	0.1066	-0.3519116	0.0004	12.80122
Average	-	3.324	-0.1	0.011844	-0.0391	-	-

From Equation (1), $MPE = -3.91$

From Equation (2), MBE = - 0.1

From Equation (3), RMSE = 0.1088

From Equation (4), $R^2 = 0.9918$

From Equation (5), $t_{(-stat)} = 6.59$

Table-7(b): Error analysis along 3m grid (left side) for single 150W HPSV source (for vertical lux measurements)

Sl No.	R_M	R_F	$R_F - R_M$	$(R_F - R_M)^2$	$(R_F - R_M) / R_F$	$R_F - R_{F(avg)}$	$(R_F - R_{F(avg)})^2$
1	1.01	1	-0.01	0.0001	-0.000102041	-0.19555	0.038239803
2	1.14	1.1	-0.04	0.0016	-0.000408163	-0.09555	0.009129802
3	1.26	1.22	-0.04	0.0016	-0.000408163	0.02445	0.000597803
4	1.4	1.37	-0.03	0.0009	-0.000306122	0.17445	0.030432803
5	1.38	1.36	-0.02	0.0004	-0.000204082	0.16445	0.027043803
6	1.38	1.37	-0.01	0.0001	-0.000102041	0.17445	0.030432803
7	1.25	1.21	-0.04	0.0016	-0.000408163	0.01445	0.000208803
8	1.17	1.13	-0.04	0.0016	-0.000408163	-0.06555	0.004296803
9	1.01	1	-0.01	0.0001	-0.000102041	-0.19555	0.038239803
Sum	-	10.76	-0.24	0.008	-0.00244898	0.00005	0.178622223
Average	-	1.1956	-0.02666	0.000089	-0.0002722	-	-

From Equation (1), MPE = - 0.027

From Equation (2), MBE = - 0.02666

From Equation (3), RMSE = 0.0298

From Equation (4), $R^2 = 0.9552$

From Equation (5), $t_{(-stat)} = 2.828$

Table-8(a): Error analysis along 3m grid (right side) from the pole for single 150W HPSV source (for horizontal lux measurements)

Sl No.	R_M	R_F	$R_F - R_M$	$(R_F - R_M)^2$	$(R_F - R_M) / R_F$	$R_F - R_{F(avg)}$	$(R_F - R_{F(avg)})^2$
1	4.84	4.75	-0.09	0.0081	-0.0189474	1.4078	1.981901
2	4.89	4.78	-0.11	0.0121	-0.0230126	1.4378	2.067269
3	4.58	4.49	-0.09	0.0081	-0.0200445	1.1478	1.317445
4	4.07	4.05	-0.02	0.0004	-0.0049383	0.7078	0.500981
5	3.49	3.47	-0.02	0.0004	-0.0057637	0.1278	0.016333
6	2.93	2.83	-0.1	0.01	-0.0353357	-0.5122	0.262349
7	2.42	2.37	-0.05	0.0025	-0.021097	-0.9722	0.945173
8	1.98	1.88	-0.1	0.01	-0.0531915	-1.4622	2.138029
9	1.62	1.46	-0.16	0.0256	-0.109589	-1.8822	3.542677

Contd.

Sum	-	30.08	-0.74	0.0772	-0.2919197	0.0002	12.77216
Average	-	3.342	-0.08	0.008533	-0.03188	-	-

From Equation (1), MPE = - 3.188

From Equation (2), MBE = - 0.08

From Equation (3), RMSE = 0.0923

From Equation (4), $R^2 = 0.9939$

From Equation (5), $t_{(-stat)} = 4.899$

Table-8(b): Error analysis along 3m grid (right side) for single 150W HPSV source (for vertical lux measurements)

Sl No.	R_M	R_F	$R_F - R_M$	$(R_F - R_M)^2$	$(R_F - R_M) / R_F$	$R_F - R_{F(avg)}$	$(R_F - R_{F(avg)})^2$
1	1.01	1.02	0.01	0.0001	0.00980392	-0.19222	0.036948528
2	1.14	1.11	-0.03	0.0009	-0.027027027	-0.10222	0.010448928
3	1.26	1.24	-0.02	0.0004	-0.016129032	0.02778	0.000771728
4	1.4	1.39	-0.01	0.0001	-0.007194245	0.17778	0.031605728
5	1.38	1.39	0.01	0.0001	0.00719424	0.17778	0.031605728
6	1.38	1.39	0.01	0.0001	0.00719424	0.17778	0.031605728
7	1.25	1.23	-0.02	0.0004	-0.016260163	0.01778	0.000316128
8	1.17	1.14	-0.03	0.0009	-0.026315789	-0.07222	0.005215728
9	1.01	1	-0.01	0.0001	-0.01	-0.21222	0.045037328
Sum	-	10.91	-0.09	0.0031	-0.078733845	0.00002	0.193555556
Average	-	1.2122	-0.01	0.000344	-0.0087477	-	-

From Equation (1), MPE = - 0.87477

From Equation (2), MBE = - 0.01

From Equation (3), RMSE= 0.018547

From Equation (4), $R^2 = 0.984$

From Equation (5), $t_{(-stat)} = 1.8107$

Table-9(a): Error analysis along 4m grid (left side) for single 150W HPSV source (for horizontal lux measurements)

Sl No.	R_M	R_F	$R_F - R_M$	$(R_F - R_M)^2$	$(R_F - R_M) / R_F$	$R_F - R_{F(avg)}$	$(R_F - R_{F(avg)})^2$
1	3.95	3.82	-0.13	0.0169	-0.0340314	0.959	0.919681
2	4.05	3.97	-0.08	0.0064	-0.0201511	1.109	1.229881
3	3.86	3.82	-0.04	0.0016	-0.0104712	0.959	0.919681
4	3.49	3.36	-0.13	0.0169	-0.0386905	0.499	0.249001
5	3.04	3	-0.04	0.0016	-0.0133333	0.139	0.019321

Contd.

6	2.59	2.52	-0.07	0.0049	-0.0277778	-0.341	0.116281
7	2.17	2.11	-0.06	0.0036	-0.028436	-0.751	0.564001
8	1.8	1.72	-0.08	0.0064	-0.0465116	-1.141	1.301881
9	1.49	1.42	-0.07	0.0049	-0.0492958	-1.441	2.076481
Sum	-	25.74	-0.7	0.0632	-0.2686988	-0.009	7.396209
Average	-	2.861	-0.0778	0.007022	-0.029855	-	-

From Equation (1), MPE = - 2.9855

From Equation (2), MBE = - 0.07777

From Equation (3), RMSE = 0.08379

From Equation (4), $R^2 = 0.9914$

From Equation (5), $t_{(-stat)} = 7.0488$

Table-9(b): Error analysis along 4m grid (left side) for single 150W HPSV source (for vertical lux measurements)

Sl No.	R_M	R_F	$R_F - R_M$	$(R_F - R_M)^2$	$(R_F - R_M) / R_F$	$R_F - R_{F(avg)}$	$(R_F - R_{F(avg)})^2$
1	1.26	1.21	-0.05	0.0025	-0.000396825	-0.0144	0.00020736
2	1.35	1.32	-0.03	0.0009	-0.000238095	0.0956	0.00913936
3	1.4	1.37	-0.03	0.0009	-0.000238095	0.1456	0.02119936
4	1.41	1.39	-0.02	0.0004	-0.00015873	0.1656	0.02742336
5	1.36	1.32	-0.04	0.0016	-0.00031746	0.0956	0.00913936
6	1.34	1.31	-0.03	0.0009	-0.000238095	0.0856	0.00732736
7	1.22	1.17	-0.05	0.0025	-0.000396825	-0.0544	0.00295936
8	1.08	1.02	-0.06	0.0036	-0.00047619	-0.2044	0.04177936
9	0.94	0.91	-0.03	0.0009	-0.000238095	-0.3144	0.09884736
Sum	-	11.02	-0.34	0.0142	-0.002698413	0.0004	0.21802224
Average	-	1.2244	-0.03777	0.001578	-0.0003	-	-

From Equation (1), MPE = - 0.03

From Equation (2), MBE = - 0.03777

From Equation (3), RMSE = 0.039721

From Equation (4), $R^2 = 0.9349$

From Equation (5), $t_{(-stat)} = 8.688$

Table-10(a): Error analysis along 4m grid (right side) for single 150W HPSV source (for horizontal lux measurements)

Sl No.	R _M	R _F	R _F - R _M	(R _F -R _M) ²	(R _F -R _M)/ R _F	R _F - R _{F(avg)}	(R _F - R _{F(avg)}) ²
1	3.95	3.84	-0.11	0.0121	-0.0286458	0.97556	0.951717
2	4.05	3.99	-0.06	0.0036	-0.0150376	1.12556	1.266885
3	3.86	3.88	0.02	0.0004	0.005155	1.01556	1.031362
4	3.49	3.38	-0.11	0.0121	-0.0325444	0.51556	0.265802
5	3.04	3.01	-0.03	0.0009	-0.0099668	0.14556	0.021188
6	2.59	2.55	-0.04	0.0016	-0.0156863	-0.31444	0.098873
7	2.17	2.14	-0.03	0.0009	-0.0140187	-0.72444	0.524813
8	1.8	1.74	-0.06	0.0036	-0.0344828	-1.12444	1.264365
9	1.49	1.45	-0.04	0.0016	-0.0275862	-1.41444	2.000641
Sum	-	25.98	-0.46	0.0368	-0.1728139	0.20004	7.425646
Average	-	2.864	-0.0733	0.013422	-0.0254814	-	-

From Equation (1), MPE = - 2.548

From Equation (2), MBE = - 0.073333

From Equation (3), RMSE = 0.11585

From Equation (4), R² = 0.983

From Equation (5), t_(-stat) = 2.3125

Table-10(b): Error analysis along 4m grid (right side) for single 150W HPSV source (for vertical lux measurements)

Sl No.	R _M	R _F	R _F - R _M	(R _F -R _M) ²	(R _F -R _M)/ R _F	R _F - R _{F(avg)}	(R _F - R _{F(avg)}) ²
1	1.26	1.23	-0.03	0.0009	-0.024390244	-0.0089	7.921E-05
2	1.35	1.34	-0.01	0.0001	-0.007462687	0.1011	0.01022121
3	1.4	1.38	-0.02	0.0004	-0.014492754	0.1411	0.01990921
4	1.41	1.37	-0.04	0.0016	-0.02919708	0.1311	0.01718721
5	1.36	1.34	-0.02	0.0004	-0.014925373	0.1011	0.01022121
6	1.34	1.33	-0.01	0.0001	-0.007518797	0.0911	0.00829921
7	1.22	1.19	-0.03	0.0009	-0.025210084	-0.0489	0.00239121
8	1.08	1.03	-0.05	0.0025	-0.048543689	-0.2089	0.04363921
9	0.94	0.9	-0.04	0.0016	-0.044444444	-0.3389	0.11485321
Sum	-	11.11	-0.25	0.0085	-0.216185152	-0.0401	0.22680089
Average	-	1.2389	-0.02333	0.000467	-0.024020572	-	-

From Equation (1), MPE = -2.4021

From Equation (2), MBE = - 0.023333

From Equation (3), RMSE = 0.027689

From Equation (4), $R^2 = 0.9625$

From Equation (5), $t_{(-stat)} = 4.4268$

Table-11(a): Error analysis along 5m grid (right side) for single 150W HPSV source (for horizontal lux measurements)

SI No.	R_M	R_F	$R_F - R_M$	$(R_F - R_M)^2$	$(R_F - R_M) / R_F$	$R_F - R_{F(avg)}$	$(R_F - R_{F(avg)})^2$
1	3.11	3.1	-0.01	1×10^{-04}	-0.0032258	0.7	0.49
2	3.24	3.22	-0.02	0.0004	-0.0062112	0.82	0.6724
3	3.15	3.11	-0.04	0.0016	-0.0128617	0.71	0.5041
4	2.9	2.87	-0.03	0.0009	-0.010453	0.47	0.2209
5	2.57	2.51	-0.06	0.0036	-0.0239044	0.11	0.0121
6	2.23	2.16	-0.07	0.0049	-0.0324074	-0.24	0.0576
7	1.9	1.83	-0.07	0.0049	-0.0382514	-0.57	0.3249
8	1.59	1.51	-0.08	0.0064	-0.0529801	-0.89	0.7921
9	1.33	1.29	-0.04	0.0016	-0.0310078	-1.11	1.2321
Sum	-	21.6	-0.42	0.0244	-0.2113027	0	4.3062
Average	-	2.4	-0.0467	0.002711	-0.023478	-	-

From Equation (1), $MPE = -2.3478$

From Equation (2), $MBE = -0.046667$

From Equation (3), $RMSE = 0.05207$

From Equation (4), $R^2 = 0.9943$

From Equation (5), $t_{(-stat)} = 5.7181$

Table-11(b): Error analysis along 5m grid (right side) for single 150W HPSV source (for vertical lux measurements)

SI No.	R_M	R_F	$R_F - R_M$	$(R_F - R_M)^2$	$(R_F - R_M) / R_F$	$R_F - R_{F(avg)}$	$(R_F - R_{F(avg)})^2$
1	1.39	1.32	-0.07	0.0049	-0.053030303	0.1	0.01
2	1.45	1.42	-0.03	0.0009	-0.021126761	0.2	0.04
3	1.38	1.36	-0.02	0.0004	-0.014705882	0.14	0.0196
4	1.36	1.32	-0.04	0.0016	-0.03030303	0.1	0.01
5	1.38	1.33	-0.05	0.0025	-0.037593985	0.11	0.0121
6	1.27	1.22	-0.05	0.0025	-0.040983607	0	0
7	1.15	1.12	-0.03	0.0009	-0.026785714	-0.1	0.01
8	1.03	1.01	-0.02	0.0004	-0.01980198	-0.21	0.0441
9	0.9	0.88	-0.02	0.0004	-0.022727273	-0.34	0.1156
Sum	-	10.98	-0.33	0.0145	-0.267058535	5.5×10^{-16}	0.2614
Average	-	1.22	-0.036667	0.001611	-0.0296732	-	-

From Equation (1), $MPE = -2.96732$

From Equation (2), $MBE = -0.036667$

From Equation (3), RMSE = 0.04014

From Equation (4), $R^2 = 0.945$

From Equation (5), $t_{(-stat)} = 6.35$

The error values of sum and average which are calculated in Tables 2(a & b), 3(a & b), 4(a & b), 5(a & b), 6(a & b), 7(a & b), 8(a & b), 19(a & b), 10(a & b) and 11(a & b) are tabulated in Table 12.

Table-12: Sum and average values for single 150W HPSV source (for horizontal and vertical lux measurements)

Location	MPE		R^2		MBE		RMSE		$t_{(-stat)}$	
	H	V	H	V	H	V	H	V	H	V
4m(Left)	-2.986	-0.03	0.9914	0.93486	-0.07777	-0.03777	0.08379	0.03972	7.0488	8.688
3m	-3.91	-0.027	0.9918	0.9552	-0.1	-0.02666	0.1088	0.0298	6.59	2.828
2m	-2.297	-6.04	0.9985	0.9581	-0.00822	-0.065555	0.0966	0.208	8.0663	0.936
1m	-2.24	-1.5463	0.976	0.85	-0.0733	-0.00666	0.082	0.1371	5.64	0.137
0m	0	-11.86	0.9878	0.9695	-0.1544	-0.065	0.1754	0.0698	5.247	7.76
1m	-1.861	-0.075	0.9978	0.999	-0.06222	-0.04444	0.07496	0.0538	16.85	19.61
2m	-1.79	-4.524	0.9965	0.9496	-0.0666	-0.04777	0.08178	0.05585	15.37	4.6695
3m	-3.188	-0.8748	0.9939	0.984	-0.08	-0.01	0.0923	0.01855	4.899	1.8107
4m	-2.548	-2.4021	0.983	0.96252	-0.073333	-0.023333	0.11585	0.02769	2.3125	4.4268
5m(Right)	-2.348	-2.9673	0.9943	0.945	-0.046667	-0.036667	0.05207	0.04014	5.7181	6.35
Sum	-23.17	-30.346	9.911	9.50778	-0.74251	-0.363855	0.96355	0.68045	77.7417	57.216
Average	-2.32	-3.034	0.991	0.9507	-0.0743	-0.0364	0.0964	0.068	7.7741	5.721

The values obtained for MPE, R^2 , MBE, RMSE and $t_{(-stat)}$ are found to be very close to the expected values for a single 150W HPSV source. Hence, the values obtained through developed illumination design model are very close to the reality.

1.2 Statistical analysis for two 150W HPSV sources

The Table 13(a) and Table 13(b) gives the horizontal and vertical lux levels, respectively for two 150W HPSV source, as obtained in Figures 4.8, 4.9 and 4.10. The measured values are represented as ' R_F ' and computed values are represented as ' R_M '.

For determining error in each set of values (both horizontal and vertical lux levels) along every grid line i.e. at 0m grid (along axis of two poles) and from grid number 1 to 8 at interval of 1m, statistical analysis was done and the results were given in Tables 14(a&b), 15(a&b), 16(a&b), 18(a&b), 19(a&b), 20(a&b), 21(a&b), 22(a&b), 23(a&b) and 24(a&b), and their respective MPE, MBE, RMSE, R^2 and $t_{(-stat)}$ were calculated.

Table-13(a) : Computed (R_M) and measured (R_F) horizontal lux levels for two 150W HPSV source

Illuminance level, Lux																			
0m		1m		2m		3m		4m		5m		6m		7m		8m		0m	
R_M	R_F	R_M	R_F	R_M	R_F	R_M	R_F	R_M	R_F	R_M	R_F	R_M	R_F	R_M	R_F	R_M	R_F	R_M	R_F
14.95	14.42	15.2	14.94	14.93	14.51	14.45	13.94	14.11	14.02	14.11	14.21	14.45	13.94	14.93	14.51	15.2	14.84	14.95	14.24
14.99	14.3	15.32	15.06	15.18	15.03	14.84	14.06	14.58	14.19	14.58	14.21	14.84	14.06	15.18	15.03	15.32	15.36	14.99	14.13
13.97	13.79	14.35	14.13	14.35	14.21	14.17	14.02	14.01	13.87	14.01	13.76	14.17	14.02	14.35	14.21	14.35	14.32	13.97	12.94
12.4	12.03	12.79	12.12	12.9	12.59	12.85	12.23	12.78	12.31	12.78	12.34	12.85	12.23	12.9	12.59	12.79	12.23	12.4	12.05
10.66	10.09	11.04	10.73	11.21	11.02	11.25	11.1	11.24	11.04	11.24	11.09	11.25	11.1	11.21	11.02	11.04	10.53	10.66	10.12
8.99	8.4	9.34	8.78	9.53	9.32	9.61	9.42	9.63	9.35	9.63	9.38	9.61	9.42	9.53	9.32	9.34	8.81	8.99	8.35
7.49	7.13	7.8	7.28	7.99	7.8	8.09	7.92	8.13	8.07	8.13	8.09	8.09	7.92	7.99	7.8	7.8	7.31	7.49	7.15
6.21	6.16	6.46	6.12	6.64	6.6	6.74	6.41	6.79	6.36	6.79	6.39	6.74	6.41	6.64	6.6	6.46	6.15	6.21	6.19
5.13	4.95	5.35	4.94	5.5	4.98	5.59	4.97	5.64	5.01	5.64	5.07	5.59	4.97	5.5	4.98	5.35	4.78	5.13	4.99

Table-13(b): Computed (R_M) and measured (R_F) horizontal lux levels for two 150W HPSV source

Illuminance level, Lux																			
0m		1m		2m		3m		4m		5m		6m		7m		8m		0m	
R_M	R_F	R_M	R_F	R_M	R_F	R_M	R_F	R_M	R_F	R_M	R_F	R_M	R_F	R_M	R_F	R_M	R_F	R_M	R_F
2.46	2.21	3.04	2.82	3.94	3.52	4.86	4.14	5.31	5.1	5.31	5.13	4.86	4.14	3.94	3.52	3.04	2.85	2.46	2.13
3.24	3.1	3.54	2.96	4.39	4.03	5.04	5.01	5.61	5.23	5.61	5.3	5.04	5.01	4.39	4.03	3.54	2.68	3.24	3.13
3.81	3.37	4.35	3.43	4.79	4.52	5.27	5.12	5.57	5.29	5.57	5.24	5.27	5.12	4.79	4.52	4.35	3.33	3.81	3.38
4.4	4.2	4.68	4.09	5.14	5.01	5.5	5.28	5.55	5.37	5.55	5.33	5.5	5.28	5.14	5.01	4.68	4.03	4.4	4.27
4.61	4.13	4.84	4.18	5.21	5.04	5.32	5.06	5.48	5.31	5.48	5.34	5.32	5.06	5.21	5.04	4.84	4.13	4.61	4.16
4.5	3.95	4.7	4.36	4.89	4.28	5.12	5	5.24	5.05	5.24	5.09	5.12	5	4.89	4.28	4.7	4.29	4.5	3.92
4.13	4.01	4.44	4.05	4.53	4.15	4.64	4.21	4.74	4.18	4.74	4.16	4.64	4.21	4.53	4.15	4.44	4.01	4.13	4.32
3.83	3.31	3.96	3.72	4.03	3.82	4.25	4.05	4.21	4.06	4.21	4.09	4.25	4.05	4.03	3.82	3.96	3.77	3.83	3.34
3.33	3.19	3.48	3.18	3.64	3.19	3.65	3.15	3.69	3.18	3.69	3.15	3.65	3.15	3.64	3.19	3.48	3.16	3.33	3.12

Table-14(a): Error analysis along 0m grid (at left side) for two 150W HPSV source (for horizontal lux measurements)

Sl No.	R _M	R _F	R _F - R _M	(R _F -R _M) ²	(R _F -R _M)/ R _F	R _F - R _{F(avg)}	(R _F - R _{F(avg)}) ²
1	14.95	14.42	-0.53	0.2809	-0.0367545	4.3755	19.145
2	14.99	14.3	-0.69	0.4761	-0.0482517	4.2555	18.10928
3	13.97	13.79	-0.18	0.0324	-0.0130529	3.7455	14.02877
4	12.4	12.03	-0.37	0.1369	-0.0307564	1.9855	3.94221
5	10.66	10.09	-0.57	0.3249	-0.0564916	0.0455	0.00207
6	8.99	8.4	-0.59	0.3481	-0.0702381	-1.6445	2.70438
7	7.49	7.13	-0.36	0.1296	-0.0504909	-2.9145	8.49431
8	6.21	6.16	-0.05	0.0025	-0.0081169	-3.8845	15.08934
9	5.13	4.95	-0.18	0.0324	-0.0363636	-5.0945	25.95393
Sum	-	91.27	-3.52	1.7638	-0.3505167	0.8695	107.4693
Average	-	10.04	-0.3911	0.195978	-0.0389463	-	-

From Equation (1), MPE = -3.894

From Equation (2), MBE = -0.3911

From Equation (3), RMSE = 0.44269

From Equation (4), R² = 0.9954

From Equation (5), t_(-stat) = 5.333

Table-14(b): Error analysis along 0m grid (at left side) for two 150W HPSV source (for vertical lux measurements)

Sl No.	R _M	R _F	R _F - R _M	(R _F -R _M) ²	(R _F -R _M)/ R _F	R _F - R _{F(avg)}	(R _F - R _{F(avg)}) ²
1	2.46	2.21	-0.25	0.0625	-0.113122172	-1.28667	1.655519689
2	3.24	3.1	-0.14	0.0196	-0.04516129	-0.39667	0.157347089
3	3.81	3.37	-0.44	0.1936	-0.130563798	-0.12667	0.016045289
4	4.4	4.2	-0.2	0.04	-0.047619048	0.70333	0.494673089
5	4.61	4.13	-0.48	0.2304	-0.11622276	0.63333	0.401106889
6	4.5	3.95	-0.55	0.3025	-0.139240506	0.45333	0.205508089
7	4.13	4.01	-0.12	0.0144	-0.029925187	0.51333	0.263507689
8	3.83	3.31	-0.52	0.2704	-0.157099698	-0.18667	0.034845689
9	3.33	3.19	-0.14	0.0196	-0.043887147	-0.30667	0.094046489
Sum	--	31.47	-2.84	1.153	-0.822841607	-3x10 ⁻⁰⁵	3.3226
Average	-	3.4967	-0.31556	0.1281	-0.091427	-	-

From Equation (1), MPE = - 9.1427

From Equation (2), MBE = - 0.31556

From Equation (3), RMSE = 0.358

From Equation (4), $R^2 = 0.6529$

From Equation (5), $t_{(-stat)} = 5.279$

Table-15(a): Error analysis along 1m grid for two 150W HPSV source (for horizontal lux measurements)

Sl No.	R_M	R_F	$R_F - R_M$	$(R_F - R_M)^2$	$(R_F - R_M) / R_F$	$R_F - R_{F(avg)}$	$(R_F - R_{F(avg)})^2$
1	15.2	14.94	-0.26	0.0676	-0.0174029	4.4844	20.10984
2	15.32	15.06	-0.26	0.0676	-0.0172643	4.6044	21.2005
3	14.35	14.13	-0.22	0.0484	-0.0155697	3.6744	13.50122
4	12.79	12.12	-0.67	0.4489	-0.0552805	1.6644	2.770227
5	11.04	10.73	-0.31	0.0961	-0.028891	0.2744	0.075295
6	9.34	8.78	-0.56	0.3136	-0.0637813	-1.6756	2.807635
7	7.8	7.28	-0.52	0.2704	-0.0714286	-3.1756	10.08444
8	6.46	6.12	-0.34	0.1156	-0.0555556	-4.3356	18.79743
9	5.35	4.94	-0.41	0.1681	-0.082996	-5.5156	30.42184
Sum	-	94.1	-3.55	1.5963	-0.4081698	-0.0004	119.7684
Average	-	10.46	-0.3945	0.177367	-0.0453523	-	-

From Equation (1), $MPE = - 4.53523$

From Equation (2), $MBE = - 0.39445$

From Equation (3), $RMSE= 0.42115$

From Equation (4), $R^2 = 0.9866$

From Equation (5), $t_{(-stat)} = 7.56$

Table-15(b): Error analysis along 1m grid for two 150W HPSV source (for vertical lux measurements)

Sl No.	R_M	R_F	$R_F - R_M$	$(R_F - R_M)^2$	$(R_F - R_M) / R_F$	$R_F - R_{F(avg)}$	$(R_F - R_{F(avg)})^2$
1	3.04	2.82	-0.22	0.0484	-0.078014184	-0.8234	0.67798756
2	3.54	2.96	-0.58	0.3364	-0.195945946	-0.6834	0.46703556
3	4.35	3.43	-0.92	0.8464	-0.268221574	-0.2134	0.04553956
4	4.68	4.09	-0.59	0.3481	-0.144254279	0.4466	0.19945156
5	4.84	4.18	-0.66	0.4356	-0.157894737	0.5366	0.28793956
6	4.7	4.36	-0.34	0.1156	-0.077981651	0.7166	0.51351556
7	4.44	4.05	-0.39	0.1521	-0.096296296	0.4066	0.16532356
8	3.96	3.72	-0.24	0.0576	-0.064516129	0.0766	0.00586756
9	3.48	3.18	-0.3	0.09	-0.094339623	-0.4634	0.21473956
Sum	-	32.79	-4.24	2.4302	-1.17746442	-0.0006	2.57740004
Average	-	3.6434	-0.47112	0.270023	-0.13082938	-	-

From Equation (1), $MPE = -13.0829$

From Equation (2), $MBE = - 0.47112$

From Equation (3), RMSE= 0.519638

From Equation (4), $R^2 = 0.0571$

From Equation (5), $t_{(-stat)} = 6.077$

Table-16(a): Error analysis along 2m grid for two 150W HPSV source (for horizontal lux measurements)

Sl No.	R_M	R_F	$R_F - R_M$	$(R_F - R_M)^2$	$(R_F - R_M) / R_F$	$R_F - R_{F(avg)}$	$(R_F - R_{F(avg)})^2$
1	14.93	14.51	-0.42	0.1764	-0.0289456	3.8366	14.7195
2	15.18	15.03	-0.15	0.0225	-0.00998	4.3566	18.97996
3	14.35	14.21	-0.14	0.0196	-0.0098522	3.5366	12.50754
4	12.9	12.59	-0.31	0.0961	-0.0246227	1.9166	3.673356
5	11.21	11.02	-0.19	0.0361	-0.0172414	0.3466	0.120132
6	9.53	9.32	-0.21	0.0441	-0.0225322	-1.3534	1.831692
7	7.99	7.8	-0.19	0.0361	-0.024359	-2.8734	8.256428
8	6.64	6.6	-0.04	0.0016	-0.0060606	-4.0734	16.59259
9	5.5	4.98	-0.52	0.2704	-0.1044177	-5.6934	32.4148
Sum	-	96.06	-2.17	0.7029	-0.2480113	-0.0006	109.096
Average	-	10.67	-0.2411	0.0781	-0.027557	-	-

From Equation (1), MPE = - 2.7557

From Equation (2), MBE = - 24112

From Equation (3), RMSE = 0.27946

From Equation (4), $R^2 = 0.9935$

From Equation (5), $t_{(-stat)} = 4.827$

Table-16(b): Error analysis along 2m grid for two 150W HPSV source (for vertical lux measurements)

Sl No.	R_M	R_F	$R_F - R_M$	$(R_F - R_M)^2$	$(R_F - R_M) / R_F$	$R_F - R_{F(avg)}$	$(R_F - R_{F(avg)})^2$
1	3.94	3.52	-0.42	0.1764	-0.119318182	-0.6534	0.42693156
2	4.39	4.03	-0.36	0.1296	-0.089330025	-0.1434	0.02056356
3	4.79	4.52	-0.27	0.0729	-0.059734513	0.3466	0.12013156
4	5.14	5.01	-0.13	0.0169	-0.025948104	0.8366	0.69989956
5	5.21	5.04	-0.17	0.0289	-0.033730159	0.8666	0.75099556
6	4.89	4.28	-0.61	0.3721	-0.142523364	0.1066	0.01136356
7	4.53	4.15	-0.38	0.1444	-0.091566265	-0.0234	0.00054756
8	4.03	3.82	-0.21	0.0441	-0.054973822	-0.3534	0.12489156
9	3.64	3.19	-0.45	0.2025	-0.141065831	-0.9834	0.96707556
Sum	-	37.56	-3	1.1878	-0.758190265	-0.0006	3.12240004
Average	-	4.1734	-0.33333	0.13198	-0.084244	-	-

From Equation (1), MPE = - 8.4244

From Equation (2), MBE = - 0.33333

From Equation (3), RMSE= 0.3633

From Equation (4), $R^2 = 0.62$

From Equation (5), $t_{(-stat)} = 6.525$

Table-17(a): Error analysis along 3m grid for two 150W HPSV source (for horizontal lux measurements)

Sl No.	R_M	R_F	$R_F - R_M$	$(R_F - R_M)^2$	$(R_F - R_M) / R_F$	$R_F - R_{F(avg)}$	$(R_F - R_{F(avg)})^2$
1	14.45	13.94	-0.51	0.2601	-0.0365854	3.4877	12.16405
2	14.84	14.06	-0.78	0.6084	-0.0554765	3.6077	13.0155
3	14.17	14.02	-0.15	0.0225	-0.010699	3.5677	12.72848
4	12.85	12.23	-0.62	0.3844	-0.050695	1.7777	3.160217
5	11.25	11.1	-0.15	0.0225	-0.0135135	0.6477	0.419515
6	9.61	9.42	-0.19	0.0361	-0.0201699	-1.0323	1.065643
7	8.09	7.92	-0.17	0.0289	-0.0214646	-2.5323	6.412543
8	6.74	6.41	-0.33	0.1089	-0.0514821	-4.0423	16.34019
9	5.59	4.97	-0.62	0.3844	-0.1247485	-5.4823	30.05561
Sum	-	94.07	-3.52	1.8562	-0.3848345	-0.0007	95.36176
Average	-	10.45	-0.3911	0.20625	-0.04276	-	-

From Equation (1), MPE = - 4.276

From Equation (2), MBE = - 0.39112

From Equation (3), RMSE= 0.45415

From Equation (4), $R^2 = 0.9805$

From Equation (5), $t_{(-stat)} = 4.8$

Table-17(b): Error analysis along 3m grid for two 150W HPSV source (for vertical lux measurements)

Sl No.	R_M	R_F	$R_F - R_M$	$(R_F - R_M)^2$	$(R_F - R_M) / R_F$	$R_F - R_{F(avg)}$	$(R_F - R_{F(avg)})^2$
1	4.86	4.14	-0.72	0.5184	-0.173913043	-0.4178	0.17455684
2	5.04	5.01	-0.03	0.0009	-0.005988024	0.4522	0.20448484
3	5.27	5.12	-0.15	0.0225	-0.029296875	0.5622	0.31606884
4	5.5	5.28	-0.22	0.0484	-0.041666667	0.7222	0.52157284
5	5.32	5.06	-0.26	0.0676	-0.051383399	0.5022	0.25220484
6	5.12	5	-0.12	0.0144	-0.024	0.4422	0.19554084
7	4.64	4.21	-0.43	0.1849	-0.102137767	-0.3478	0.12096484
8	4.25	4.05	-0.2	0.04	-0.049382716	-0.5078	0.25786084
9	3.65	3.15	-0.5	0.25	-0.158730159	-1.4078	1.98190084

Sum	-	41.02	-2.63	1.1471	-0.63649865	-0.0002	4.02515556
Average	-	4.5578	-0.292223	0.127456	-0.0707221	-	-

From Equation (1), MPE = -7.07221

From Equation (2), MBE = - 0.292223

From Equation (3), RMSE= 0.35701

From Equation (4), $R^2 = 0.715$

From Equation (5), $t_{(-stat)} = 4.03$

Table-18(a): Error analysis along 4m grid for two 150W HPSV source (for horizontal lux measurements)

Sl No.	R_M	R_F	$R_F - R_M$	$(R_F - R_M)^2$	$(R_F - R_M) / R_F$	$R_F - R_{F(avg)}$	$(R_F - R_{F(avg)})^2$
1	14.11	14.02	-0.09	0.0081	-0.0064194	3.5511	12.61031
2	14.58	14.19	-0.39	0.1521	-0.0274841	3.7211	13.84659
3	14.01	13.87	-0.14	0.0196	-0.0100937	3.4011	11.56748
4	12.78	12.31	-0.47	0.2209	-0.0381803	1.8411	3.389649
5	11.24	11.04	-0.2	0.04	-0.0181159	0.5711	0.326155
6	9.63	9.35	-0.28	0.0784	-0.0299465	-1.1189	1.251937
7	8.13	8.07	-0.06	0.0036	-0.0074349	-2.3989	5.754721
8	6.79	6.36	-0.43	0.1849	-0.0676101	-4.1089	16.88306
9	5.64	5.01	-0.63	0.3969	-0.1257485	-5.4589	29.79959
Sum	-	94.22	-2.69	1.1045	-0.3310336	-0.0001	95.42949
Average	-	10.47	-0.2989	0.122723	-0.0367816	-	-

From Equation (1), MPE = - 3.67816

From Equation (2), MBE = - 0.29889

From Equation (3), RMSE= 0.35032

From Equation (4), $R^2 = 0.9884$

From Equation (5), $t_{(-stat)} = 8.4625$

Table-18(b): Error analysis along 4m grid for two 150W HPSV source (for vertical lux measurements)

Sl No.	R_M	R_F	$R_F - R_M$	$(R_F - R_M)^2$	$(R_F - R_M) / R_F$	$R_F - R_{F(avg)}$	$(R_F - R_{F(avg)})^2$
1	5.31	5.1	0.21	0.0441	0.041176471	0.347777	0.120948842
2	5.61	5.23	0.38	0.1444	0.072657744	0.477777	0.228270862
3	5.57	5.29	0.28	0.0784	0.052930057	0.537777	0.289204102
4	5.55	5.37	0.18	0.0324	0.033519553	0.617777	0.381648422
5	5.48	5.31	0.17	0.0289	0.032015066	0.557777	0.311115182
6	5.24	5.05	0.19	0.0361	0.037623762	0.297777	0.088671142

Contd.

7	4.74	4.18	0.56	0.3136	0.133971292	-0.572223	0.327439162
8	4.21	4.06	0.15	0.0225	0.036945813	-0.692223	0.479172682
9	3.69	3.18	0.51	0.2601	0.160377358	-1.572223	2.471885162
Sum	-	42.77	2.63	0.9605	0.601217116	-0.000007	4.698355556
Average	-	4.7522	0.29223	0.106723	0.066802	-	-

From Equation (1), MPE = - 6.6802

From Equation (2), MBE = - 0.29223

From Equation (3), RMSE= 0.326685

From Equation (4), $R^2 = 0.8$

From Equation (5), $t_{(-stat)} = 5.66$

Table-19(a): Error analysis along 5m grid for two 150W HPSV source (for horizontal lux measurements)

Sl No.	R_M	R_F	$R_F - R_M$	$(R_F - R_M)^2$	$(R_F - R_M) / R_F$	$R_F - R_{F(avg)}$	$(R_F - R_{F(avg)})^2$
1	14.11	14.21	0.1	0.01	-0.007037	3.7055	13.73073
2	14.58	14.21	-0.37	0.1369	0.026038	3.7055	13.73073
3	14.01	13.76	-0.25	0.0625	0.0181686	3.2555	10.59828
4	12.78	12.34	-0.44	0.1936	0.0356564	1.8355	3.36906
5	11.24	11.09	-0.15	0.0225	0.0135257	0.5855	0.34281
6	9.63	9.38	-0.25	0.0625	0.0266525	-1.1245	1.2645
7	8.13	8.09	-0.04	0.0016	0.0049444	-2.4145	5.82981
8	6.79	6.39	-0.4	0.16	0.0625978	-4.1145	16.92911
9	5.64	5.07	-0.57	0.3249	0.112426	-5.4345	29.53379
Sum	-	94.54	-2.37	0.9745	0.2929721	-0.0005	95.32882
Average	-	10.5	-0.2633	0.10828	0.032553	-	-

From Equation (1), MPE = -3.2553

From Equation (2), MBE = - 0.263334

From Equation (3), RMSE= 0.32906

From Equation (4), $R^2 = 0.9897$

From Equation (5), $t_{(-stat)} = 3.774$

Table-19(b): Error analysis along 5m grid for two 150W HPSV source (for vertical lux measurements)

Sl No.	R_M	R_F	$R_F - R_M$	$(R_F - R_M)^2$	$(R_F - R_M) / R_F$	$R_F - R_{F(avg)}$	$(R_F - R_{F(avg)})^2$
1	5.31	5.13	-0.18	0.0324	-0.012667136	0.37111	0.137722632
2	5.61	5.3	-0.31	0.0961	-0.021815623	0.54111	0.292800032
3	5.57	5.24	-0.33	0.1089	-0.023982558	0.48111	0.231466832

Contd.

4	5.55	5.33	-0.22	0.0484	-0.017828201	0.57111	0.326166632
5	5.48	5.34	-0.14	0.0196	-0.012623986	0.58111	0.337688832
6	5.24	5.09	-0.15	0.0225	-0.015991471	0.33111	0.109633832
7	4.74	4.16	-0.58	0.3364	-0.071693449	-0.59889	0.358669232
8	4.21	4.09	-0.12	0.0144	-0.018779343	-0.66889	0.447413832
9	3.69	3.15	-0.54	0.2916	-0.106508876	-1.60889	2.588527032
Sum	-	42.83	-2.57	0.9703	-0.301890642	-0.00001	4.830088889
Average	-	4.7589	-0.28556	0.107812	-0.0335435	-	-

From Equation (1), MPE = - 3.35435

From Equation (2), MBE = - 0.28556

From Equation (3), RMSE= 0.328347

From Equation (4), $R^2 = 0.8$

From Equation (5), $t_{(-stat)} = 9.325$

Table-20(a): Error analysis along 6m grid for two 150W HPSV source (for horizontal lux measurements)

SI No.	R_M	R_F	$R_F - R_M$	$(R_F - R_M)^2$	$(R_F - R_M) / R_F$	$R_F - R_{F(avg)}$	$(R_F - R_{F(avg)})^2$
1	14.45	13.94	-0.51	0.2601	-0.0365854	3.48777	12.16454
2	14.84	14.06	-0.78	0.6084	-0.0554765	3.60777	13.016
3	14.17	14.02	-0.15	0.0225	-0.010699	3.56777	12.72898
4	12.85	12.23	-0.62	0.3844	-0.050695	1.77777	3.160466
5	11.25	11.1	-0.15	0.0225	-0.0135135	0.64777	0.419606
6	9.61	9.42	-0.19	0.0361	-0.0201699	-1.03223	1.065499
7	8.09	7.92	-0.17	0.0289	-0.0214646	-2.53223	6.412189
8	6.74	6.41	-0.33	0.1089	-0.0514821	-4.04223	16.33962
9	5.59	4.97	-0.62	0.3844	-0.1247485	-5.48223	30.05485
Sum	-	94.07	-3.52	1.8562	-0.3848345	-0.00007	95.36176
Average	-	10.45	-0.3911	0.206245	-0.0427594	-	-

From Equation (1), MPE = - 4.27594

From Equation (2), MBE = - 0.391112

From Equation (3), RMSE = 0.45414

From Equation (4), $R^2 = 0.9805$

From Equation (5), $t_{(-stat)} = 4.792$

Table-20(b): Error analysis along 6m grid for two 150W HPSV source (for vertical lux measurements)

Sl No.	R _M	R _F	R _F - R _M	(R _F -R _M) ²	(R _F -R _M)/ R _F	R _F - R _{F(avg)}	(R _F - R _{F(avg)}) ²
1	4.86	4.14	-0.72	0.5184	-0.173913043	-0.417778	0.174538457
2	5.04	5.01	-0.03	0.0009	-0.005988024	0.452222	0.204504737
3	5.27	5.12	-0.15	0.0225	-0.029296875	0.562222	0.316093577
4	5.5	5.28	-0.22	0.0484	-0.041666667	0.722222	0.521604617
5	5.32	5.06	-0.26	0.0676	-0.051383399	0.502222	0.252226937
6	5.12	5	-0.12	0.0144	-0.024	0.442222	0.195560297
7	4.64	4.21	-0.43	0.1849	-0.102137767	-0.347778	0.120949537
8	4.25	4.05	-0.2	0.04	-0.049382716	-0.507778	0.257838497
9	3.65	3.15	-0.5	0.25	-0.158730159	-1.407778	1.981838897
Sum	-	41.02	-2.63	1.1471	-0.63649865	-0.000002	4.025155556
Average	-	4.5578	-0.29223	0.127456	-0.0707221	-	-

From Equation (1), MPE = - 7.07221

From Equation (2), MBE = - 0.29223

From Equation (3), RMSE= 0.35701

From Equation (4), R² = 0.715

From Equation (5), t_(-stat) = 6.162

Table-21(a): Error analysis along 7m grid for two 150W HPSV source (for horizontal lux measurements)

Sl No.	R _M	R _F	R _F - R _M	(R _F -R _M) ²	(R _F -R _M)/ R _F	R _F - R _{F(avg)}	(R _F - R _{F(avg)}) ²
1	14.93	14.51	-0.42	0.1764	-0.0289456	3.83666	14.71996
2	15.18	15.03	-0.15	0.0225	-0.00998	4.35666	18.98049
3	14.35	14.21	-0.14	0.0196	-0.0098522	3.53666	12.50796
4	12.9	12.59	-0.31	0.0961	-0.0246227	1.91666	3.673586
5	11.21	11.02	-0.19	0.0361	-0.0172414	0.34666	0.120173
6	9.53	9.32	-0.21	0.0441	-0.0225322	-1.35334	1.831529
7	7.99	7.8	-0.19	0.0361	-0.024359	-2.87334	8.256083
8	6.64	6.6	-0.04	0.0016	-0.0060606	-4.07334	16.5921
9	5.5	4.98	-0.52	0.2704	-0.1044177	-5.69334	32.41412
Sum	-	96.06	-2.17	0.7029	-0.2480113	-6E-05	109.096
Average	-	10.67	-0.2411	0.0781	-0.0275568	-	-

From Equation (1), MPE = - 2.75569

From Equation (2), MBE = - 0.241111

From Equation (3), RMSE = 0.27946

From Equation (4), $R^2 = 0.9935$

From Equation (5), $t_{(-stat)} = 4.826$

Table-21(b): Error analysis along 7m grid for two 150W HPSV source (for vertical lux measurements)

Sl No.	R_M	R_F	$R_F - R_M$	$(R_F - R_M)^2$	$(R_F - R_M) / R_F$	$R_F - R_{F(avg)}$	$(R_F - R_{F(avg)})^2$
1	3.94	3.52	-0.42	0.1764	-0.119318182	-0.653334	0.426845316
2	4.39	4.03	-0.36	0.1296	-0.089330025	-0.143334	0.020544636
3	4.79	4.52	-0.27	0.0729	-0.059734513	0.346666	0.120177316
4	5.14	5.01	-0.13	0.0169	-0.025948104	0.836666	0.700009996
5	5.21	5.04	-0.17	0.0289	-0.033730159	0.866666	0.751109956
6	4.89	4.28	-0.61	0.3721	-0.142523364	0.106666	0.011377636
7	4.53	4.15	-0.38	0.1444	-0.091566265	-0.023334	0.000544476
8	4.03	3.82	-0.21	0.0441	-0.054973822	-0.353334	0.124844916
9	3.64	3.19	-0.45	0.2025	-0.141065831	-0.983334	0.966945756
Sum	-	37.56	-3	1.1878	-0.758190265	-0.000006	3.1224
Average	-	4.1733	-0.333333	0.131978	-0.0842434	-	-

From Equation (1), MPE = - 8.42434

From Equation (2), MBE = - 0.333333

From Equation (3), RMSE= 0.363288

From Equation (4), $R^2 = 0.62$

From Equation (5), $t_{(-stat)} = 6.526$

Table-22(a): Error analysis along 8m grid for two 150W HPSV source (for horizontal lux measurements)

Sl No.	R_M	R_F	$R_F - R_M$	$(R_F - R_M)^2$	$(R_F - R_M) / R_F$	$R_F - R_{F(avg)}$	$(R_F - R_{F(avg)})^2$
1	15.2	14.84	-0.36	0.1296	-0.0242588	4.35888	18.99983
2	15.32	15.36	0.04	0.0016	0.002604	4.87888	23.80347
3	14.35	14.32	-0.03	0.0009	-0.002095	3.83888	14.737
4	12.79	12.23	-0.56	0.3136	-0.045789	1.74888	3.058581
5	11.04	10.53	-0.51	0.2601	-0.048433	0.04888	0.002389
6	9.34	8.81	-0.53	0.2809	-0.0601589	-1.67112	2.792642
7	7.8	7.31	-0.49	0.2401	-0.0670315	-3.17112	10.056
8	6.46	6.15	-0.31	0.0961	-0.0504065	-4.33112	18.7586
9	5.35	4.78	-0.57	0.3249	-0.1192469	-5.70112	32.50277
Sum	-	94.33	-3.32	1.6478	-0.4148154	-0.00008	124.7113
Average	-	10.48	-0.3689	0.183089	-0.0460906	-	-

From Equation (1), MPE = - 4.60906

From Equation (2), MBE = - 0.368889

From Equation (3), RMSE = 0.42789

From Equation (4), $R^2 = 0.9867$

From Equation (5), $t_{(-stat)} = 4.813$

Table-22(b): Error analysis along 8m grid for two 150W HPSV source (for vertical lux measurements)

Sl No.	R_M	R_F	$R_F - R_M$	$(R_F - R_M)^2$	$(R_F - R_M) / R_F$	$R_F - R_{F(avg)}$	$(R_F - R_{F(avg)})^2$
1	3.04	2.85	-0.19	0.0361	-0.066666667	-0.73334	0.537787556
2	3.54	2.68	-0.86	0.7396	-0.320895522	-0.90334	0.816023156
3	4.35	3.33	-1.02	1.0404	-0.306306306	-0.25334	0.064181156
4	4.68	4.03	-0.65	0.4225	-0.161290323	0.44666	0.199505156
5	4.84	4.13	-0.71	0.5041	-0.171912833	0.54666	0.298837156
6	4.7	4.29	-0.41	0.1681	-0.095571096	0.70666	0.499368356
7	4.44	4.01	-0.43	0.1849	-0.10723192	0.42666	0.182038756
8	3.96	3.77	-0.19	0.0361	-0.050397878	0.18666	0.034841956
9	3.48	3.16	-0.32	0.1024	-0.101265823	-0.42334	0.179216756
Sum	-	32.25	-4.78	3.2342	-1.381538367	-0.00006	2.8118
Average	-	3.5833	-0.531112	0.359356	-0.153504263	-	-

From Equation (1), MPE = -15.350426

From Equation (2), MBE = - 0.531112

From Equation (3), RMSE= 0.59947

From Equation (4), $R^2 = 0.15$

From Equation (5), $t_{(-stat)} = 5.403$

Table-23(a): Error analysis along (At 9m from left side/0m at right side) grid for two 150W HPSV source (for horizontal lux measurements)

Sl No.	R_M	R_F	$R_F - R_M$	$(R_F - R_M)^2$	$(R_F - R_M) / R_F$	$R_F - R_{F(avg)}$	$(R_F - R_{F(avg)})^2$
1	14.95	14.24	-0.71	0.5041	-0.0498596	4.22222	17.82714
2	14.99	14.13	-0.86	0.7396	-0.0608634	4.11222	16.91035
3	13.97	12.94	-1.03	1.0609	-0.0795981	2.92222	8.53937
4	12.4	12.05	-0.35	0.1225	-0.0290456	2.03222	4.129918
5	10.66	10.12	-0.54	0.2916	-0.0533597	0.10222	0.010449
6	8.99	8.35	-0.64	0.4096	-0.0766467	-1.66778	2.78149
7	7.49	7.15	-0.34	0.1156	-0.0475524	-2.86778	8.224162
8	6.21	6.19	-0.02	0.0004	-0.003231	-3.82778	14.6519
9	5.13	4.99	-0.14	0.0196	-0.0280561	-5.02778	25.27857

Contd.

Sum	-	90.16	-4.63	3.2639	-0.4282127	-0.00002	98.35336
Average	-	10.02	-0.5144	0.362656	-0.040296	-	-

From Equation (1), MPE = - 4.0296

From Equation (2), MBE = - 0.514445

From Equation (3), RMSE= 0.60221

From Equation (4), $R^2 = 0.9668$

From Equation (5), $t_{(-stat)} = 4.647$

Table-23(b): Error analysis along (At 9m from left side/0m at right side) grid for two 150W HPSV source (for vertical lux measurements)

Sl No.	R_M	R_F	$R_F - R_M$	$(R_F - R_M)^2$	$(R_F - R_M) / R_F$	$R_F - R_{F(avg)}$	$(R_F - R_{F(avg)})^2$
1	2.46	2.13	-0.33	0.1089	-0.154929577	-1.4	1.96
2	3.24	3.13	-0.11	0.0121	-0.03514377	-0.4	0.16
3	3.81	3.38	-0.43	0.1849	-0.127218935	-0.15	0.0225
4	4.4	4.27	-0.13	0.0169	-0.030444965	0.74	0.5476
5	4.61	4.16	-0.45	0.2025	-0.108173077	0.63	0.3969
6	4.5	3.92	-0.58	0.3364	-0.147959184	0.39	0.1521
7	4.13	4.32	0.19	0.0361	0.04398148	0.79	0.6241
8	3.83	3.34	-0.49	0.2401	-0.146706587	-0.19	0.0361
9	3.33	3.12	-0.21	0.0441	-0.067307692	-0.41	0.1681
Sum	-	31.77	-2.54	1.182	-0.773902305	1.3×10^{-15}	4.0674
Average	-	3.53	-0.28223	0.131334	-0.08598915	-	-

From Equation (1), MPE = - 8.598915

From Equation (2), MBE = - 0.28223

From Equation (3), RMSE= 0.3624

From Equation (4), $R^2 = 0.7093$

From Equation (5), $t_{(-stat)} = 3.511$

The error values of sum and average which are calculated in Tables 14(a & b), 15(a & b), 16(a & b), 17(a & b), 18(a & b), 19(a & b), 20(a & b), 21(a & b), 22(a & b) and 23(a & b) for two 150W HPSV sources are tabulated in Table 24.

Table-24: Sum and average values analysis for two 150W HPSV sources (for horizontal and vertical lux measurements)

Location	MPE		R ²		MBE		RMSE		t _(-stat)	
	H	V	H	V	H	V	H	V	H	V
0m(Left)	-3.894	-9.1427	0.9954	0.6529	-0.3911	-0.31556	0.44269	0.358	5.333	5.279
1m	-1.861	-13.083	0.9978	0.0571	-0.06222	-0.47112	0.07496	0.51964	16.85	6.077
2m	-2.756	-8.4244	0.9935	0.62	-0.24112	-0.33333	0.27946	0.3633	4.827	6.525
3m	-4.276	-7.0722	0.9805	0.715	-0.39112	-0.292223	0.45415	0.35701	4.8	4.03
4m	-3.678	-6.6802	0.9884	0.8	-0.29889	-0.29223	0.35032	0.32669	8.462	5.66
5m	-3.255	-3.3544	0.9897	0.8	-0.26333	-0.28556	0.32906	0.32835	3.774	9.325
6m	-4.276	-7.0722	0.9805	0.715	-0.39111	-0.29223	0.45414	0.35701	4.792	6.162
7m	-2.756	-8.4243	0.9935	0.62	-0.24111	-0.333333	0.27946	0.36329	4.826	6.526
8m	-4.609	-15.35	0.9867	0.15	-0.36888	-0.531112	0.42789	0.59947	4.813	5.403
0m(Right)	-4.03	-8.5989	0.9668	0.7093	-0.51444	-0.28223	0.60221	0.3624	4.647	3.511
Sum	-35.39	-87.203	9.8728	5.8393	-3.16334	-3.42892	3.69435	3.93515	63.124	58.498
Average	- 3.54	- 8.72	0.9872	0.584	- 0.3163	- 0.3429	0.3694	0.3935	6.312	5.85

The values obtained for MPE, R², MBE, RMSE and t_(-stat) are found to be very close to the expected values for a two 150W HPSV sources. Hence, the values obtained through developed illumination design model are very close to the reality.

ANNEXURE VI

Table 1 gives the illuminance levels with respect to 150 W HPSV source with 0m, 1m and 2m arm lengths for different mounting heights (i.e. 8m, 9m, 10m, 11m and 12m) at 0° tilt angle. These values are obtained from Table 6.1, 6.2, 6.3, 6.4 and 6.5 (from chapter 6). Using the data from Table 1, graph was plotted, which is shown in Figure 1. This graph indicates the influence of mounting height on illuminance levels. As depicted in the graph (in Fig.1), the illuminance level at the center of the roadway along the axis of the pole varies with the mounting height. Among three arm lengths under consideration, the illuminance levels are high for 0m arm length, where as it was lowest for 2m arm length. The illuminance level was the maximum at 11m mounting height for all the three arm lengths.

Table-1: Illuminance levels for 0m, 1m and 2m arm lengths for different mounting heights at 0° tilt angle (for 150 W HPSV)

Mounting height (in m)	Illuminance levels (in lux)		
	Arm length 0m	Arm length 1m	Arm length 2m
8	1.01	0.71	0.52
9	0.79	0.58	0.42
10	0.53	0.46	0.35
11	1.25	0.89	0.63
12	0.5	0.38	0.29

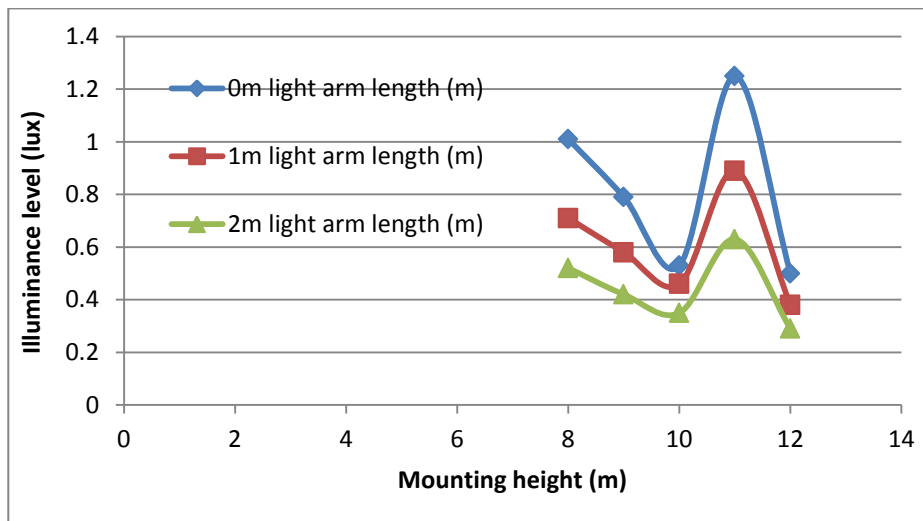

Fig. 1 Influence of mounting height on illuminance level at tilt angle $\theta = 0^\circ$

Table 2 gives the illuminance levels with respect to 150 W HPSV source with 0m, 1m and 2m arm lengths for different mounting heights (i.e. 8m, 9m, 10m, 11m and 12m) at 14° tilt angle. These values are obtained from Table 6.1, 6.2, 6.3, 6.4 and 6.5 (from chapter 6). Using the data

from Table 2, graph was plotted, which is shown in Figure 2. This graph indicates the influence of mounting height on illuminance levels. As depicted in the graph (in Fig.2), the illuminance level at the center of the roadway along the axis of the pole varies with the mounting height. Among three arm lengths under consideration, the illuminance levels are high for 0m arm length, where as it was lowest for 2m arm length. The illuminance level was the maximum at 8m mounting height for all the three arm lengths.

Table-2: Illuminance levels for 0m, 1m and 2m arm lengths for different mounting heights at 14° tilt angle (for 150 W HPSV)

Mounting height(in m)	Illuminance levels (in lux)		
	Arm length 0m	Arm length 1 m	Arm length 2m
8	17.25	11.48	9.35
9	16.43	10.8	8.8
10	14.07	8.5	7.5
11	15.37	10.13	8.83
12	12.81	7.27	5.38

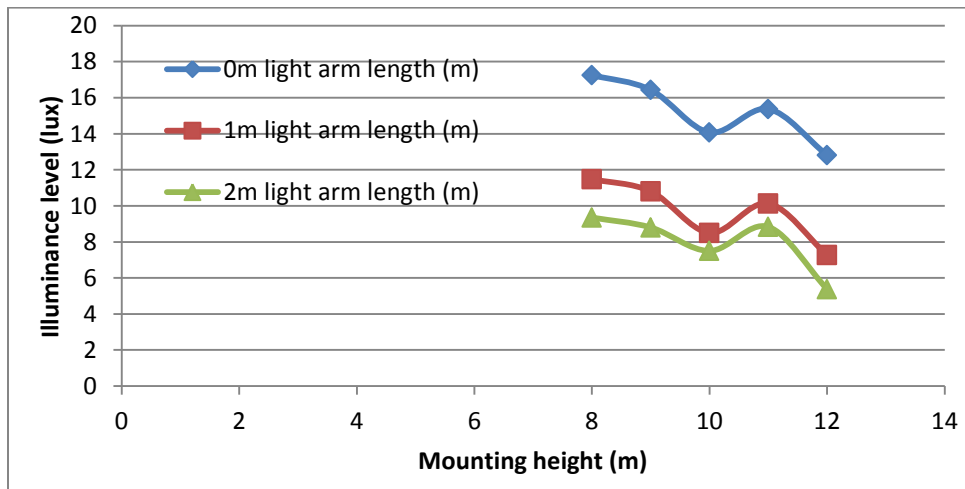

Fig. 2 Influence of mounting height on illuminance level at tilt angle $\theta = 14^\circ$

ANNEXURE - VII

Figure 1 shows the isolux contour drawn for two 70W HPSV sources, which are mounted at a height of 8m with 14° tilt angle and spaced at 19m interval. The grids are drawn at 1 m interval along the length as well as width (i.e. 12 m) of the road. The sources are located 2m beyond the curb of the roadway i.e. at 0m arm length. The contours are plotted for various lux levels, at interval of lux, such as 1.5lux, 2.5lux, 3. 5lux, 4.5lux and 5.5lux as shown in Figure 1.

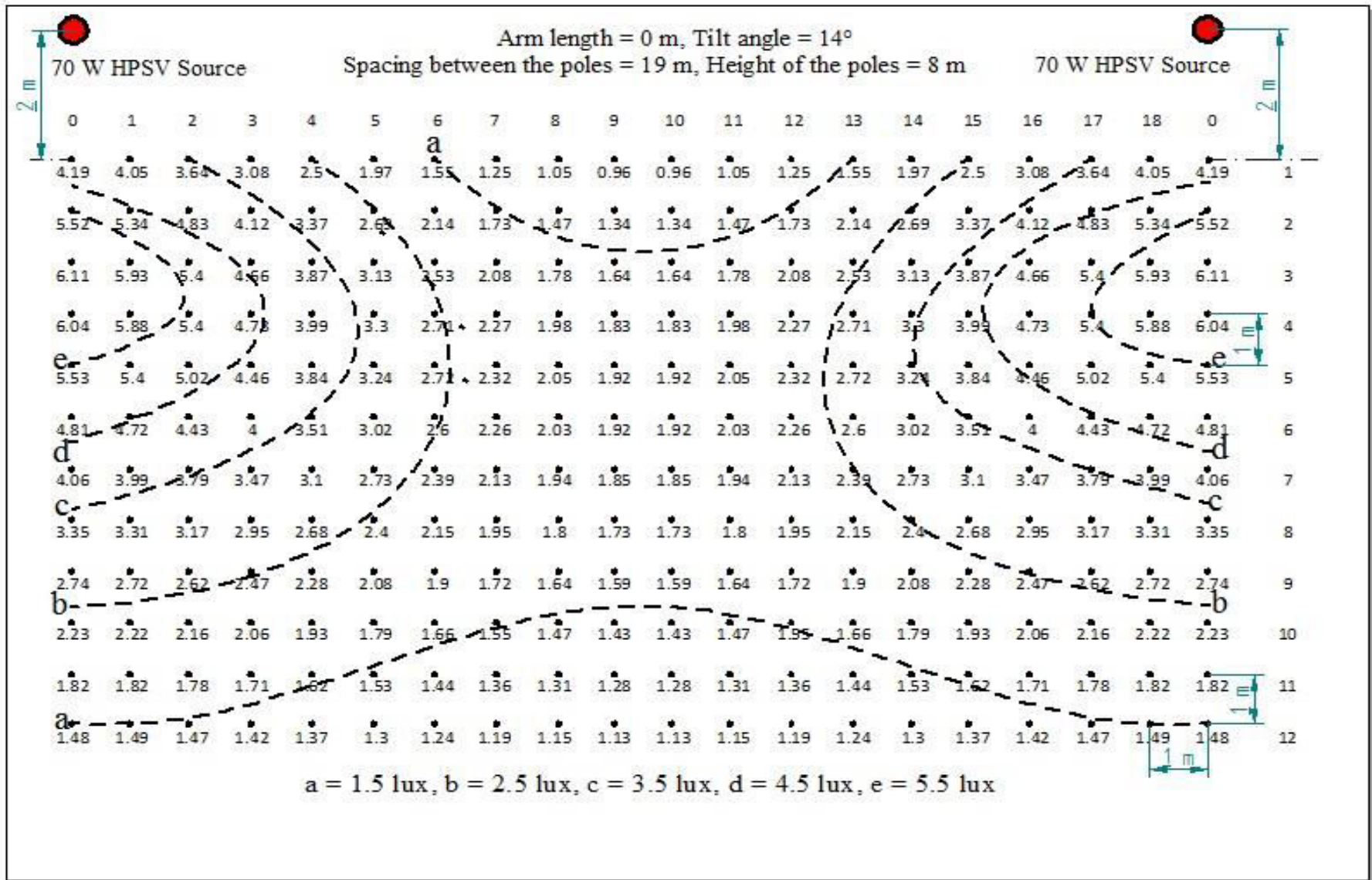

Fig.1 Isolux contour for two 70W HPSV source at 19m interval and mounted at a height of 8m with 14° tilt angle

ANNEXURE - VIII

The Figures 1(a) and 1(b) shows the input design parameters for the computer programme and computer output for horizontal lux levels between two poles respectively for two 250W LED sources mounted at height of 8m at tilt angle 14°, at arm length 0m with pole interval as 21m and the road width is 12m. Whereas Figure 1(c) indicates the output of the computer programme for minimum illuminance level, average illuminance level, maximum illuminance level and uniformity ratio.

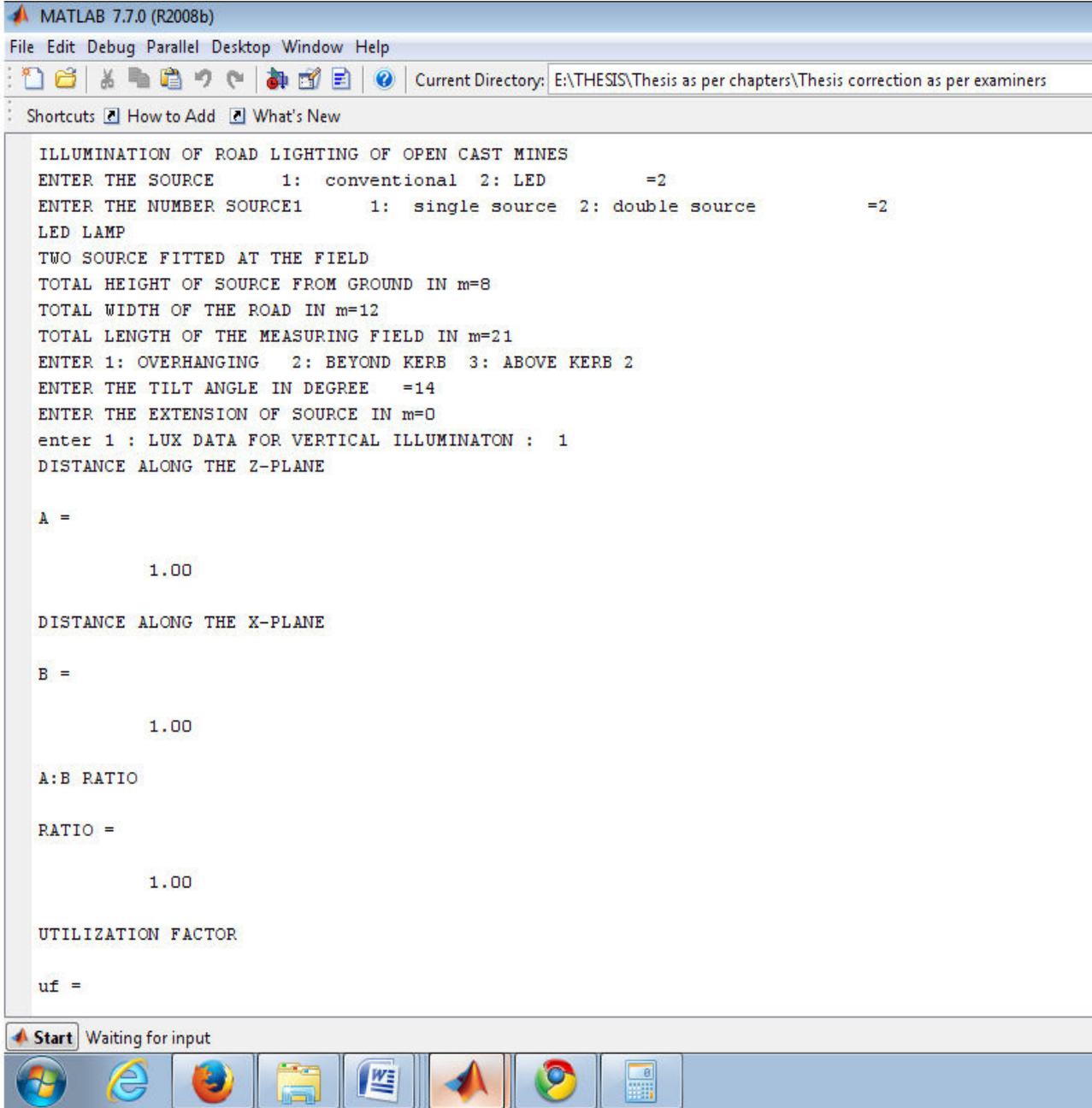

Fig. 1(a) Input design parameters for the computer programme (Mounting height=8m; Pole interval=21m)

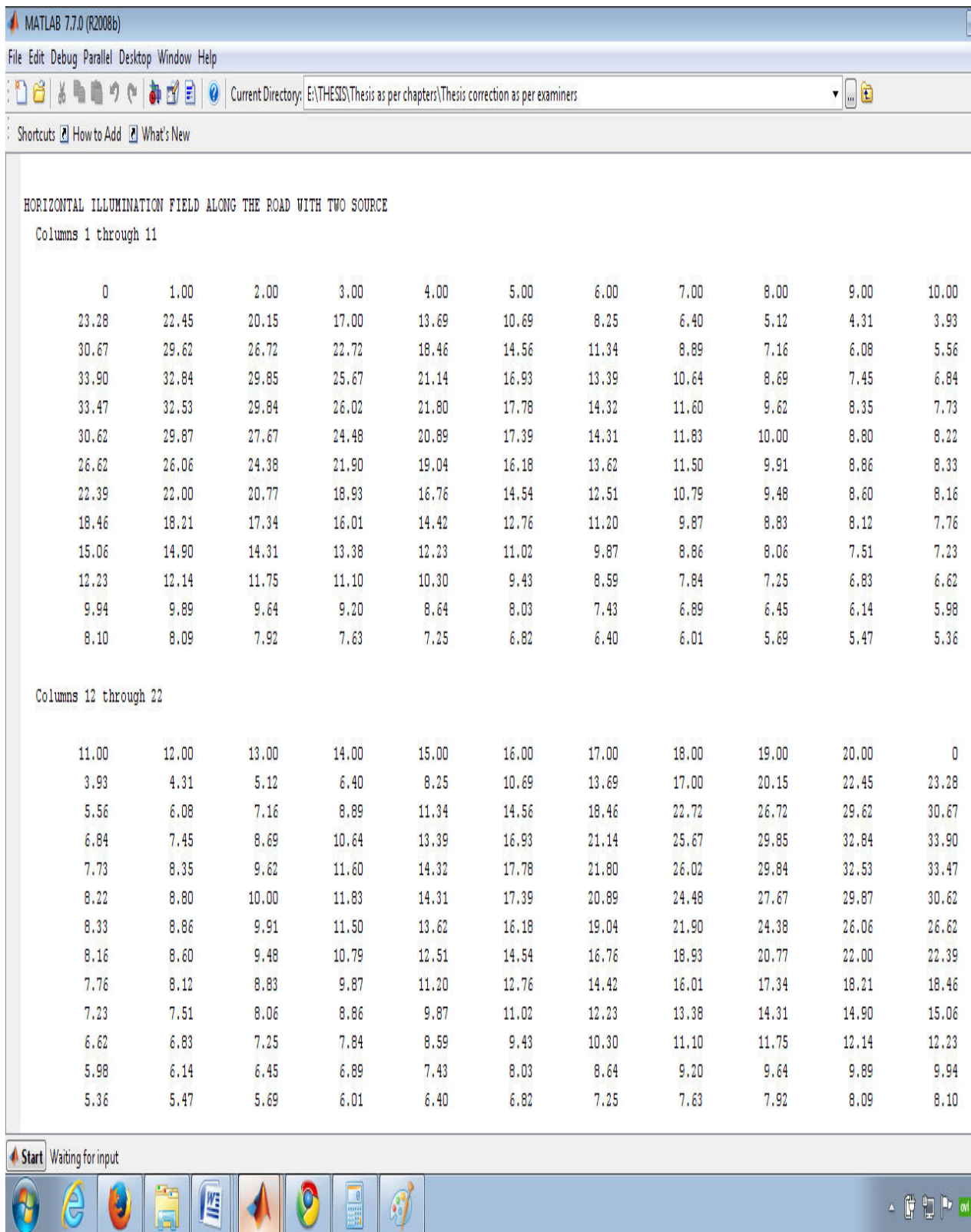

Fig. 1(b) Computer output for horizontal lux levels between two poles

```
MATLAB 7.7.0 (R2008b)
File Edit Debug Parallel Desktop Window H
Shortcuts How to Add What's New

Column 23
      0
     1.00
     2.00
     3.00
     4.00
     5.00
     6.00
     7.00
     8.00
     9.00
    10.00
    11.00
    12.00

HORIZONTAL ILLUMINATION MEAN
      13.17

UNIFORMITY RATIO

max_illumination =
      33.90

min_illumination =
      3.93

UNIFORMITY_RATIO =
      0.30
```

Fig. 1(c) Computer output for illumination levels and uniformity ratio

The Figures 2(a) and 2(b) shows the input design parameters for the computer programme and computer output for horizontal lux levels between two poles respectively for two 250W LED sources mounted at height of 8m at tilt angle 14° , at arm length 0m with pole interval as 22m and the road width is 12m. Whereas Figure 2(c) indicates the output of the computer

programme for minimum illuminance level, average illuminance level, maximum illuminance level and uniformity ratio.

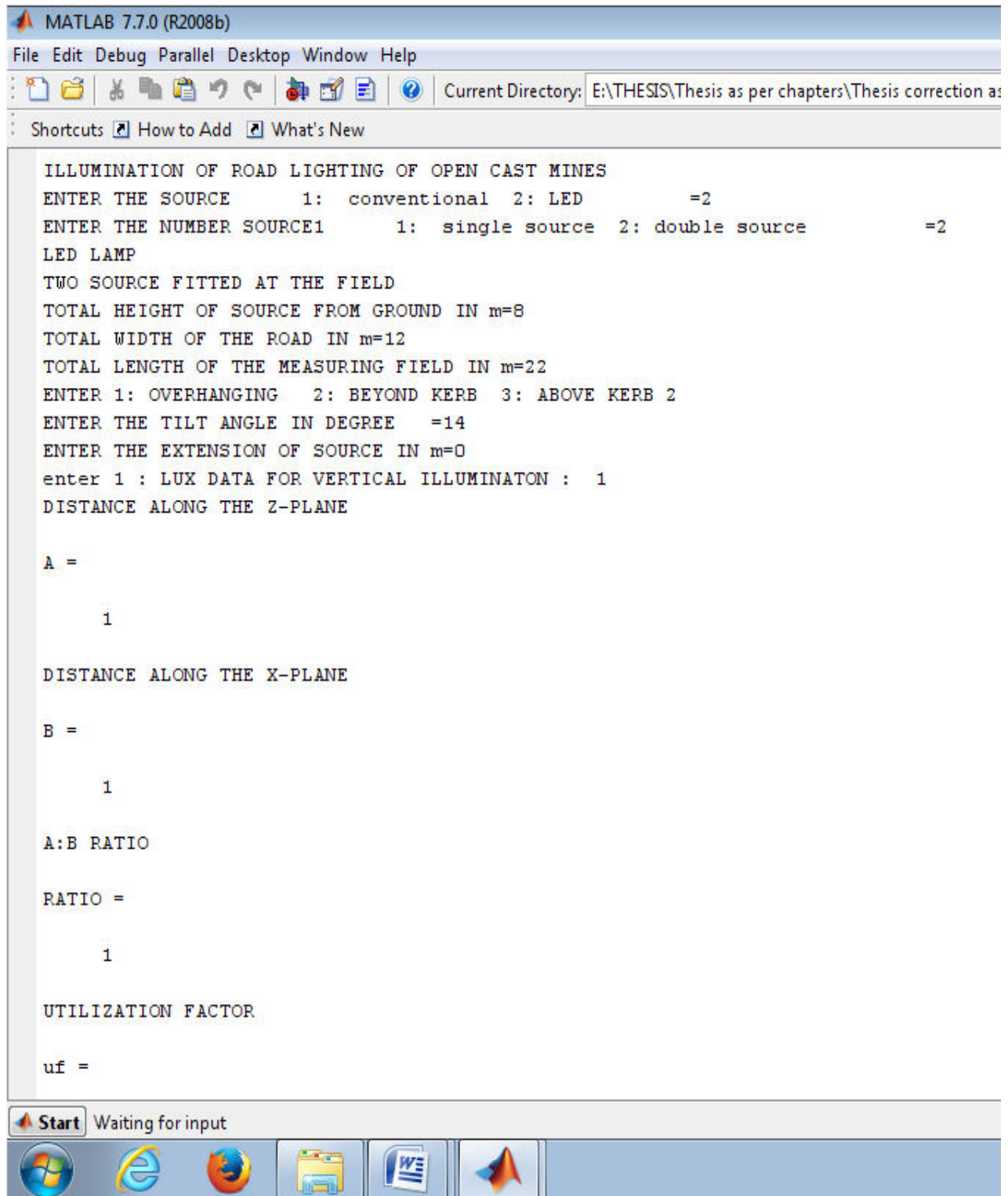

Fig. 2(a) Input design parameters for the computer programme (mounting height=8m; Pole interval=22m)

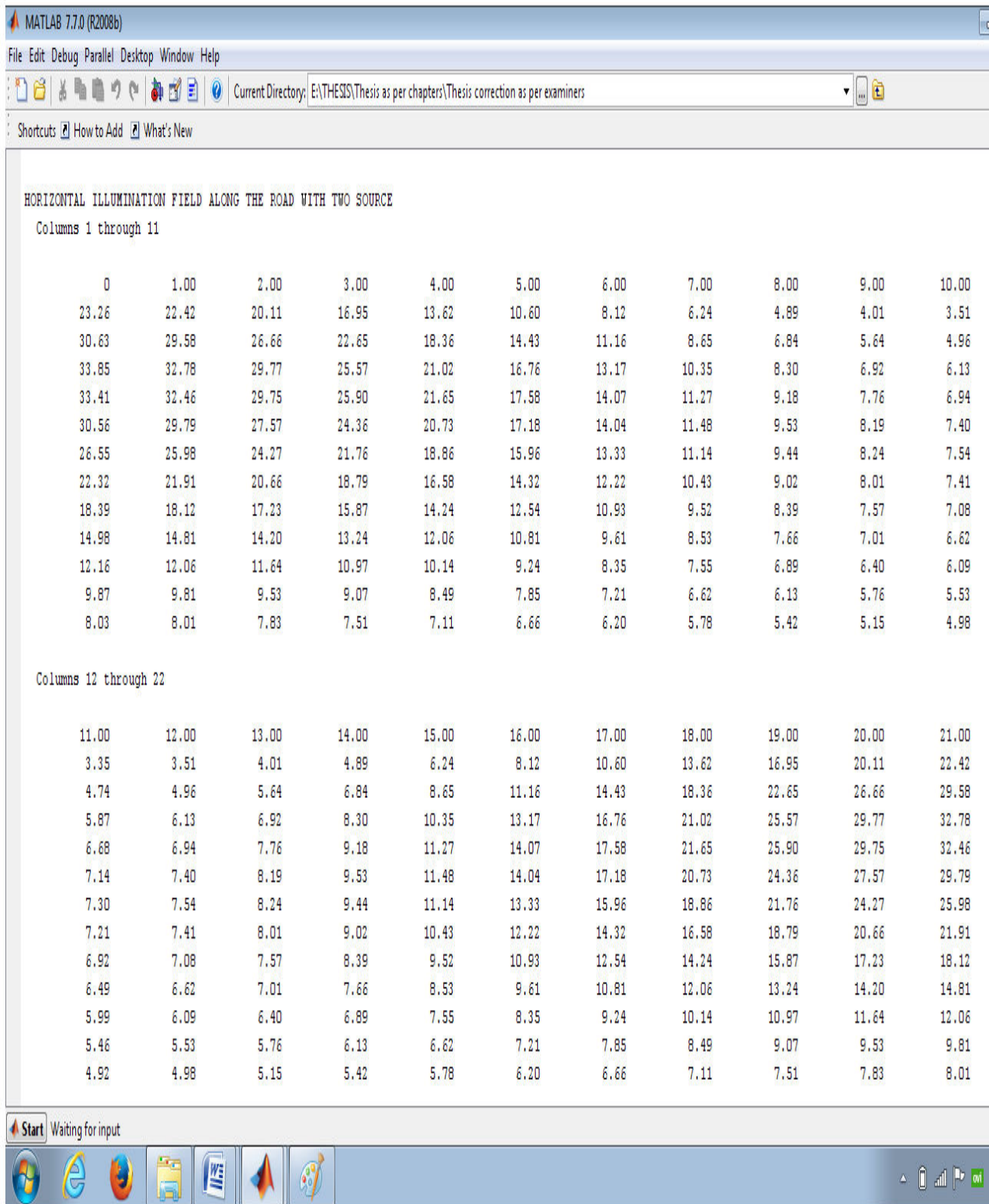
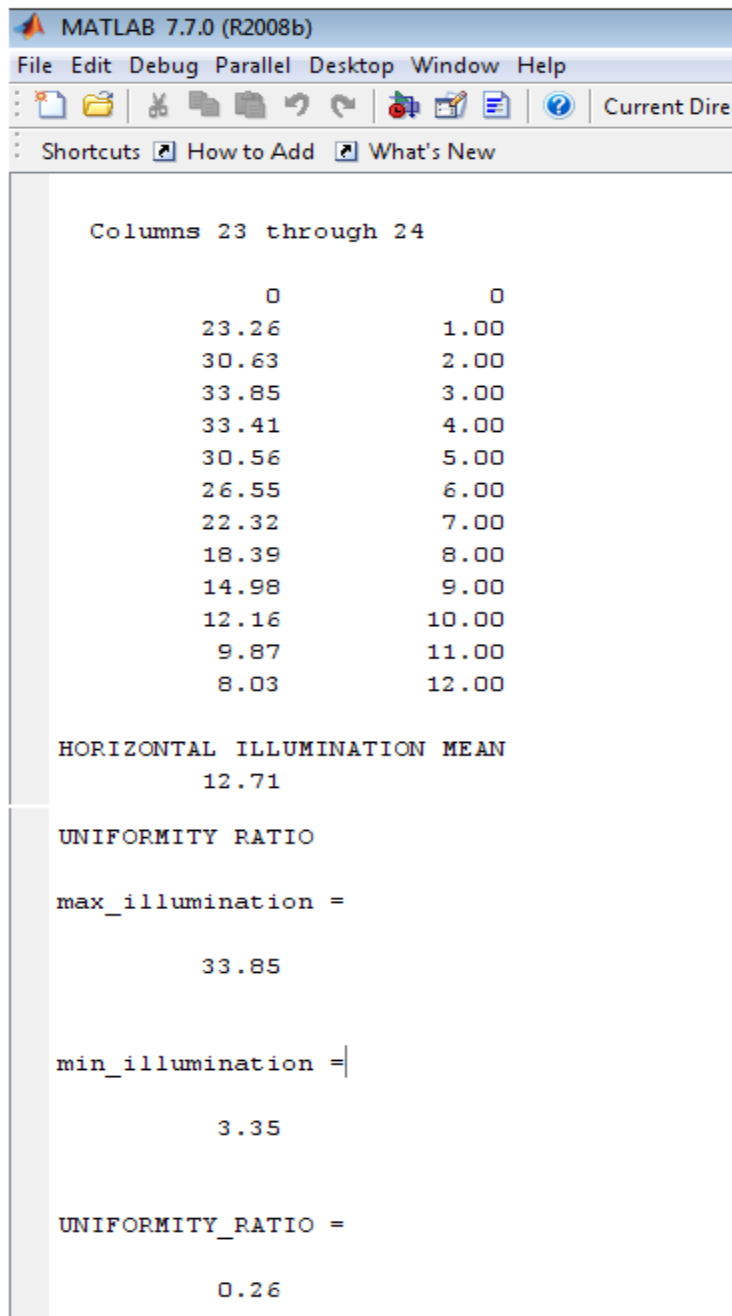

Fig. 2(b) Computer output for horizontal lux levels between two poles



```

MATLAB 7.7.0 (R2008b)
File Edit Debug Parallel Desktop Window Help
Shortcuts How to Add What's New

Columns 23 through 24

      0          0
    23.26      1.00
    30.63      2.00
    33.85      3.00
    33.41      4.00
    30.56      5.00
    26.55      6.00
    22.32      7.00
    18.39      8.00
    14.98      9.00
    12.16     10.00
     9.87     11.00
     8.03     12.00

HORIZONTAL ILLUMINATION MEAN
    12.71

UNIFORMITY RATIO

max_illumination =

    33.85

min_illumination =

     3.35

UNIFORMITY_RATIO =

     0.26

```

Fig. 2(c) Output of the computer programme

The Figures 3(a) and 3(b) shows the input design parameters for the computer programme and computer output for horizontal lux levels between two poles respectively for two 250W LED sources mounted at height of 10m at tilt angle 14° , at arm length 0m with pole interval as 23m and the road width is 12m. Whereas Figure 3(c) indicates the output of the computer

programme for minimum illuminance level, average illuminance level, maximum illuminance level and uniformity ratio.

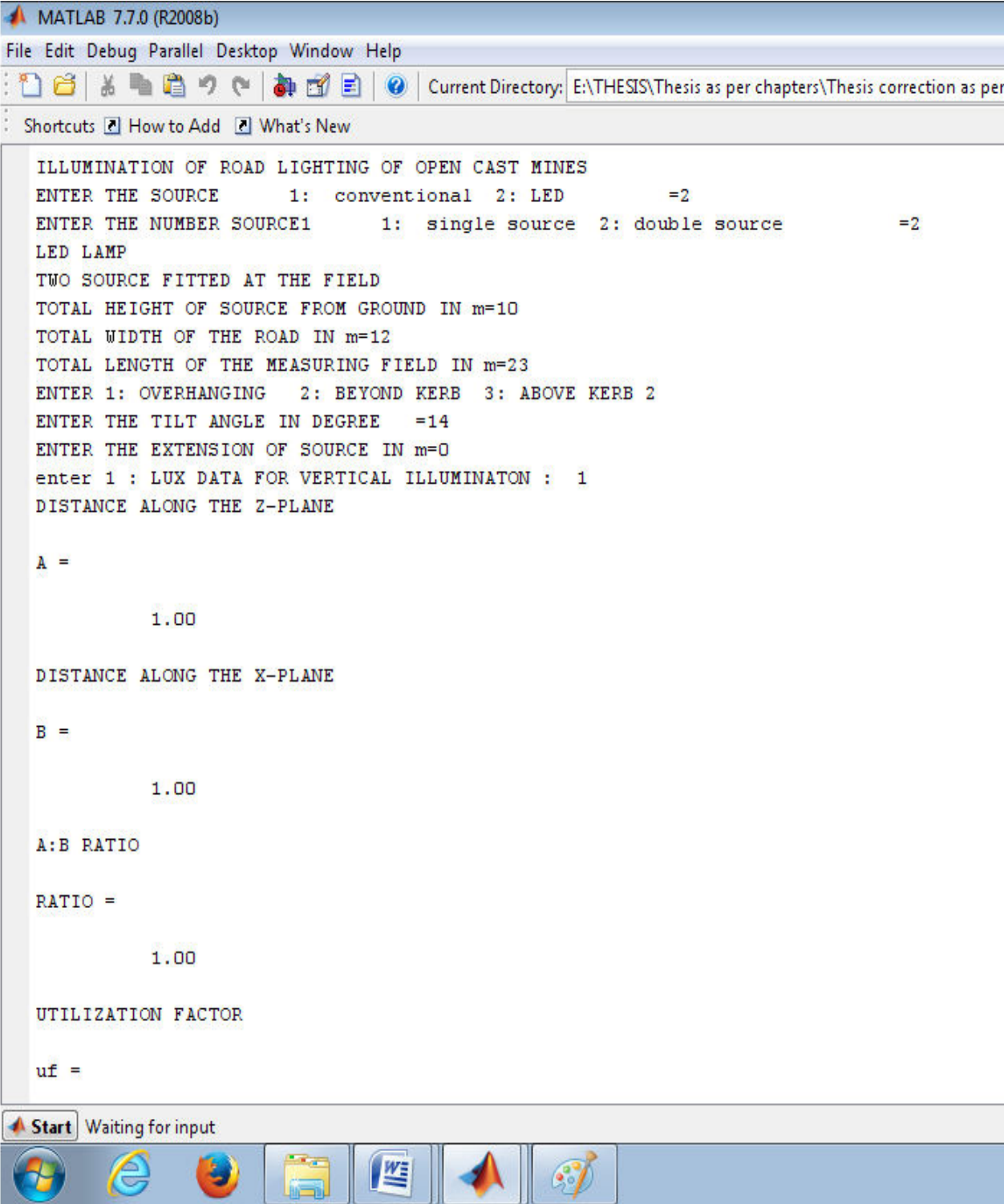

Fig. 3(a) Input design parameters for the computer programme (mounting height=10m; Pole interval=23m)

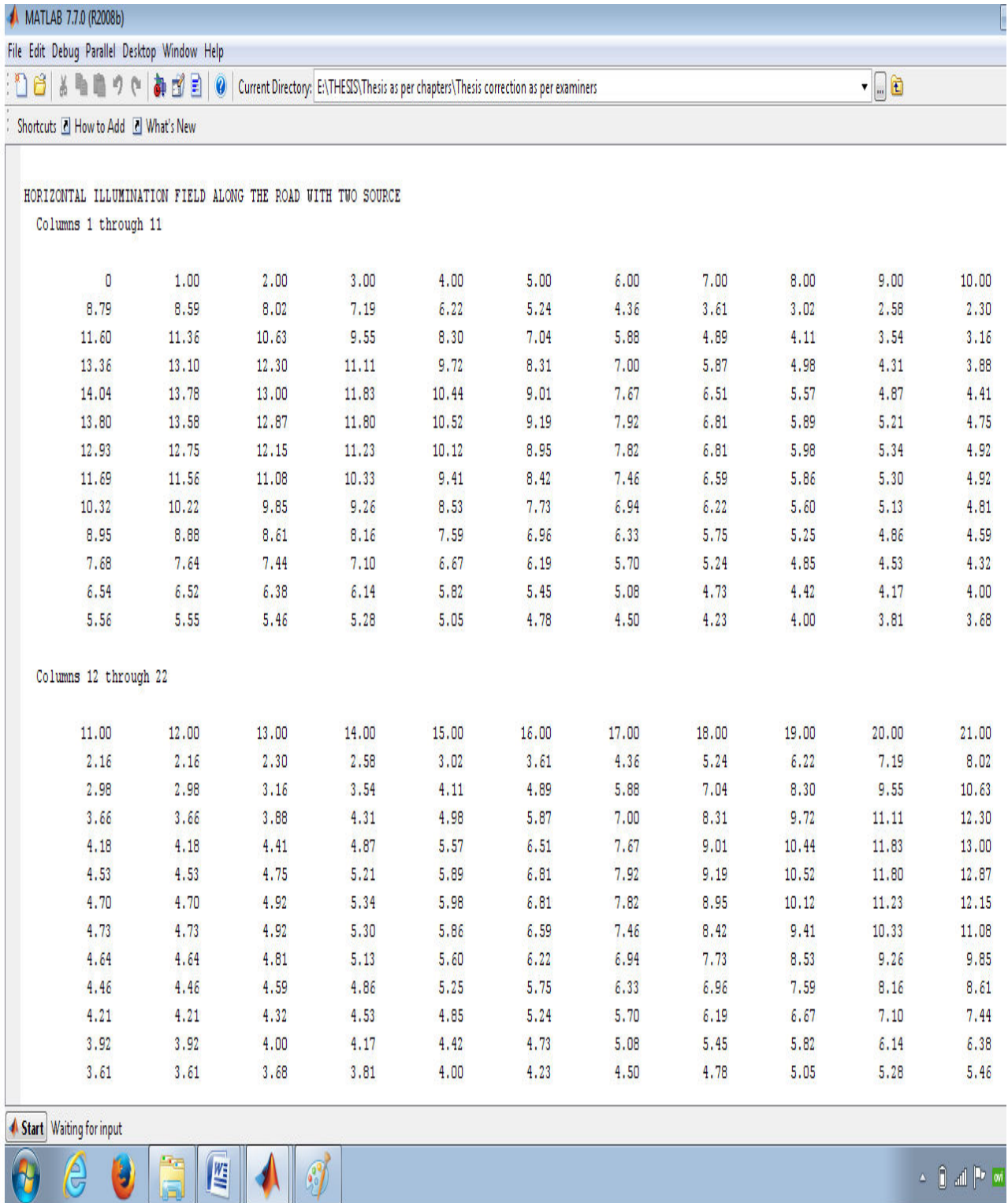
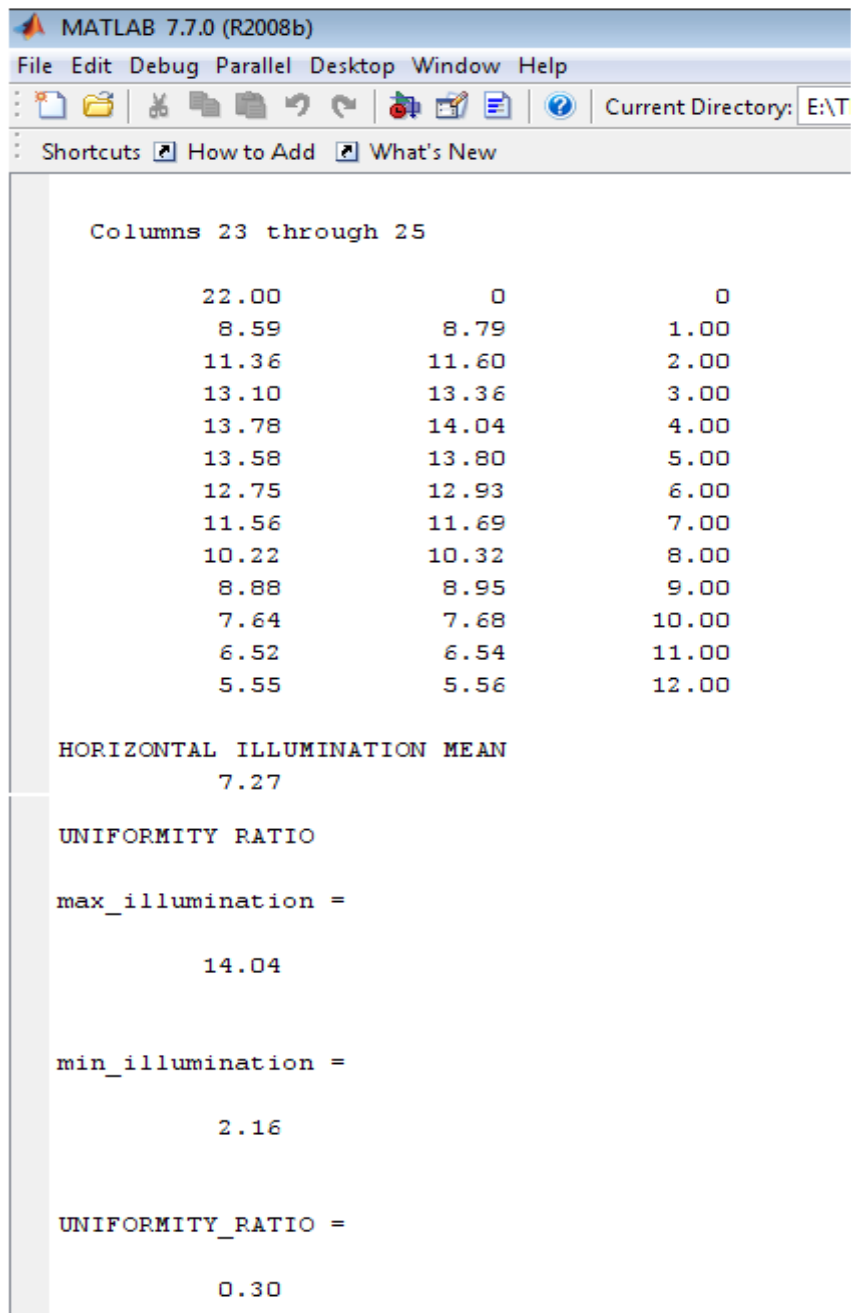

Fig. 3(b) Computer output for horizontal lux levels between two poles



```

MATLAB 7.7.0 (R2008b)
File Edit Debug Parallel Desktop Window Help
Current Directory: E:\T
Shortcuts How to Add What's New

Columns 23 through 25

    22.00         0         0
     8.59         8.79         1.00
    11.36        11.60         2.00
    13.10        13.36         3.00
    13.78        14.04         4.00
    13.58        13.80         5.00
    12.75        12.93         6.00
    11.56        11.69         7.00
    10.22        10.32         8.00
     8.88         8.95         9.00
     7.64         7.68        10.00
     6.52         6.54        11.00
     5.55         5.56        12.00

HORIZONTAL ILLUMINATION MEAN
    7.27

UNIFORMITY RATIO

max_illumination =

    14.04

min_illumination =

     2.16

UNIFORMITY_RATIO =

     0.30

```

Fig. 3(c) Output of the computer programme

The Figures 4(a) and 4(b) shows the input design parameters for the computer programme and computer output for horizontal lux levels between two poles respectively for two 250W LED sources mounted at height of 12m at tilt angle 14° , at arm length 0m with pole interval as 24m and the road width is 12m. Whereas Figure 4(c) indicates the output of the computer programme for minimum illuminance level, average illuminance level, maximum illuminance level and uniformity ratio.

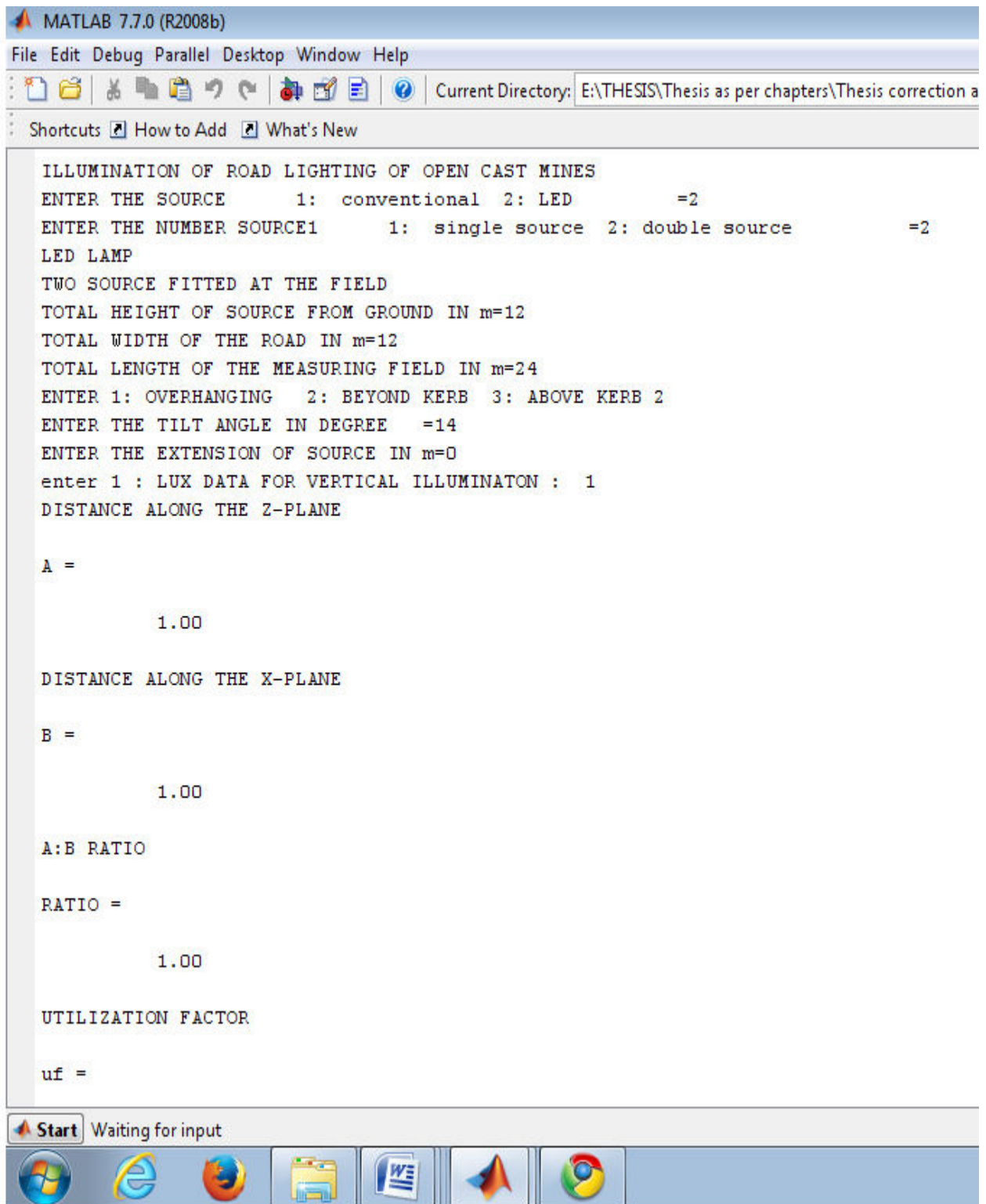

Fig. 4(a) Input design parameters for the computer programme (mounting height=12m; Pole interval=24m)

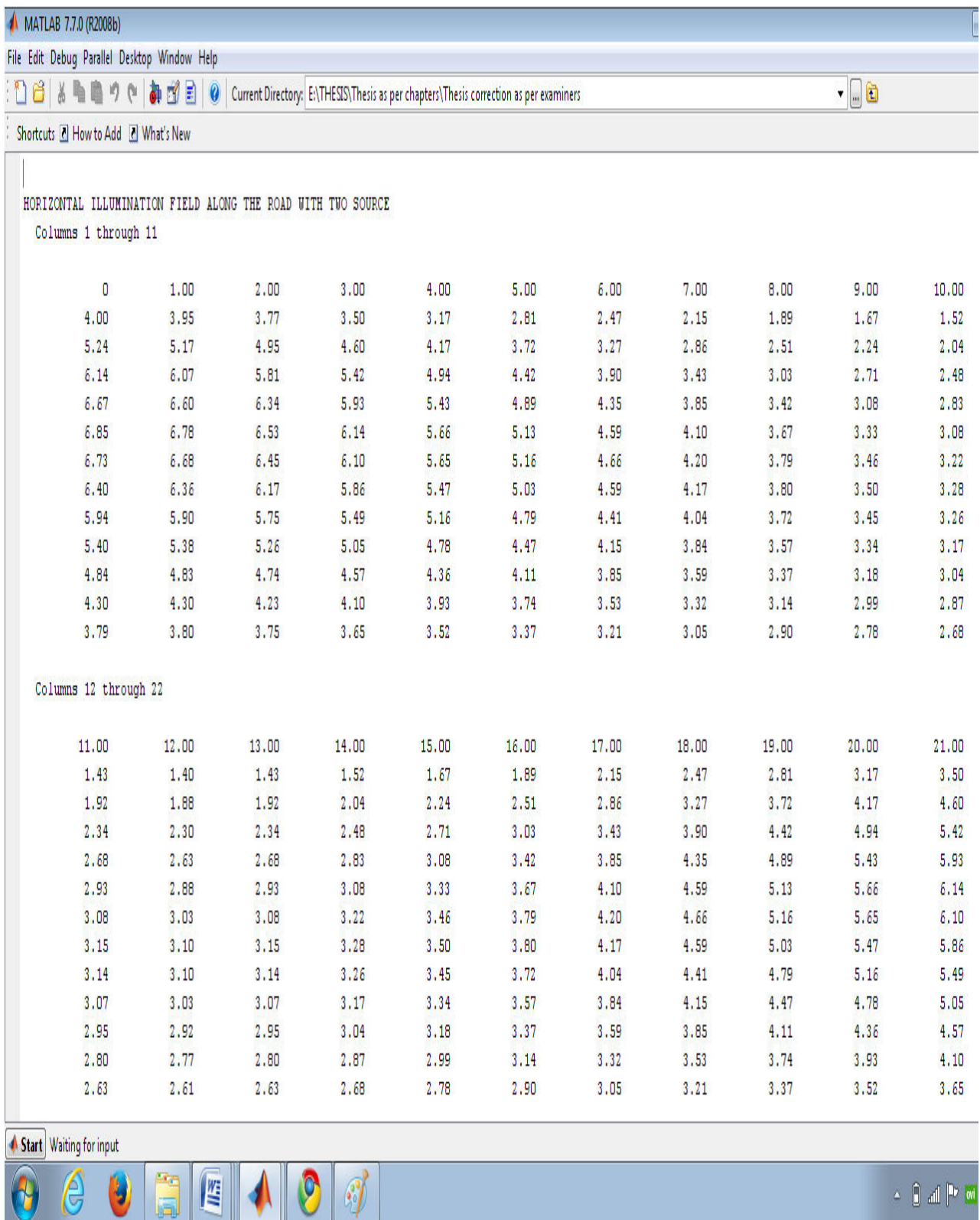

Fig. 4(b) Computer output for horizontal lux levels between two poles

```

MATLAB 7.7.0 (R2008b)
File Edit Debug Parallel Desktop Window Help
Current Directory: E:\THESIS\Thesis as per
Shortcuts How to Add What's New

Columns 23 through 26

    22.00    23.00         0         0
    3.77    3.95     4.00     1.00
    4.95    5.17     5.24     2.00
    5.81    6.07     6.14     3.00
    6.34    6.60     6.67     4.00
    6.53    6.78     6.85     5.00
    6.45    6.68     6.73     6.00
    6.17    6.36     6.40     7.00
    5.75    5.90     5.94     8.00
    5.26    5.38     5.40     9.00
    4.74    4.83     4.84    10.00
    4.23    4.30     4.30    11.00
    3.75    3.80     3.79    12.00

HORIZONTAL ILLUMINATION MEAN
    4.65

UNIFORMITY RATIO

max_illumination =

    6.85

min_illumination =

    1.40

UNIFORMITY_RATIO =

    0.30

```

Fig. 4(c) Output of the computer programme

The Figures 5(a) and 5(b) shows the input design parameters for the computer programme and computer output for horizontal lux levels between two poles respectively for two 250W LED sources mounted at height of 14m at tilt angle 14° , at arm length 0m with pole interval as 25m and the road width is 12m. Whereas Figure 5(c) indicates the output of the computer

programme for minimum illuminance level, average illuminance level, maximum illuminance level and uniformity ratio.

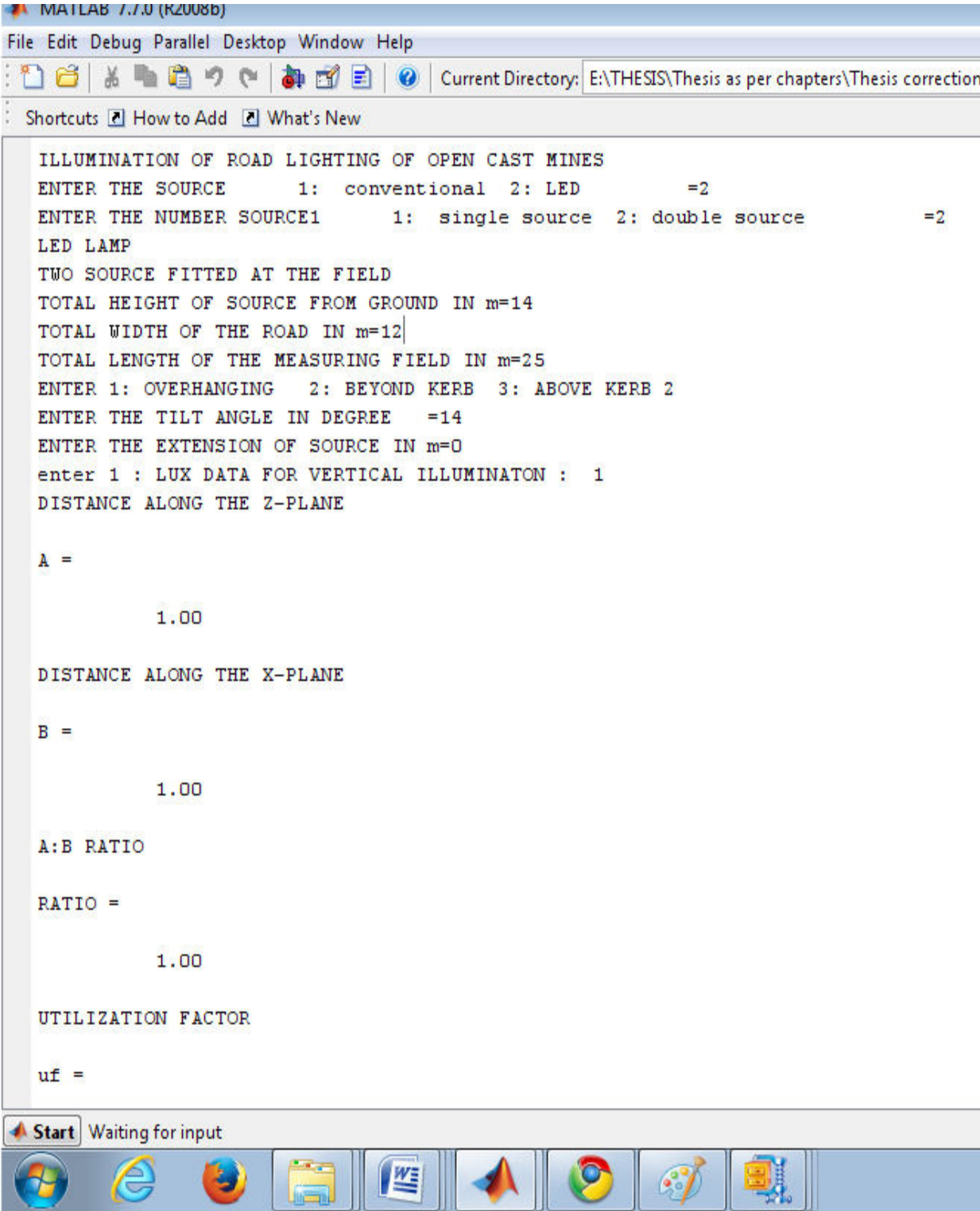

Fig. 5(a) Input design parameters for the computer programme (mounting height=14m; Pole interval=25m)

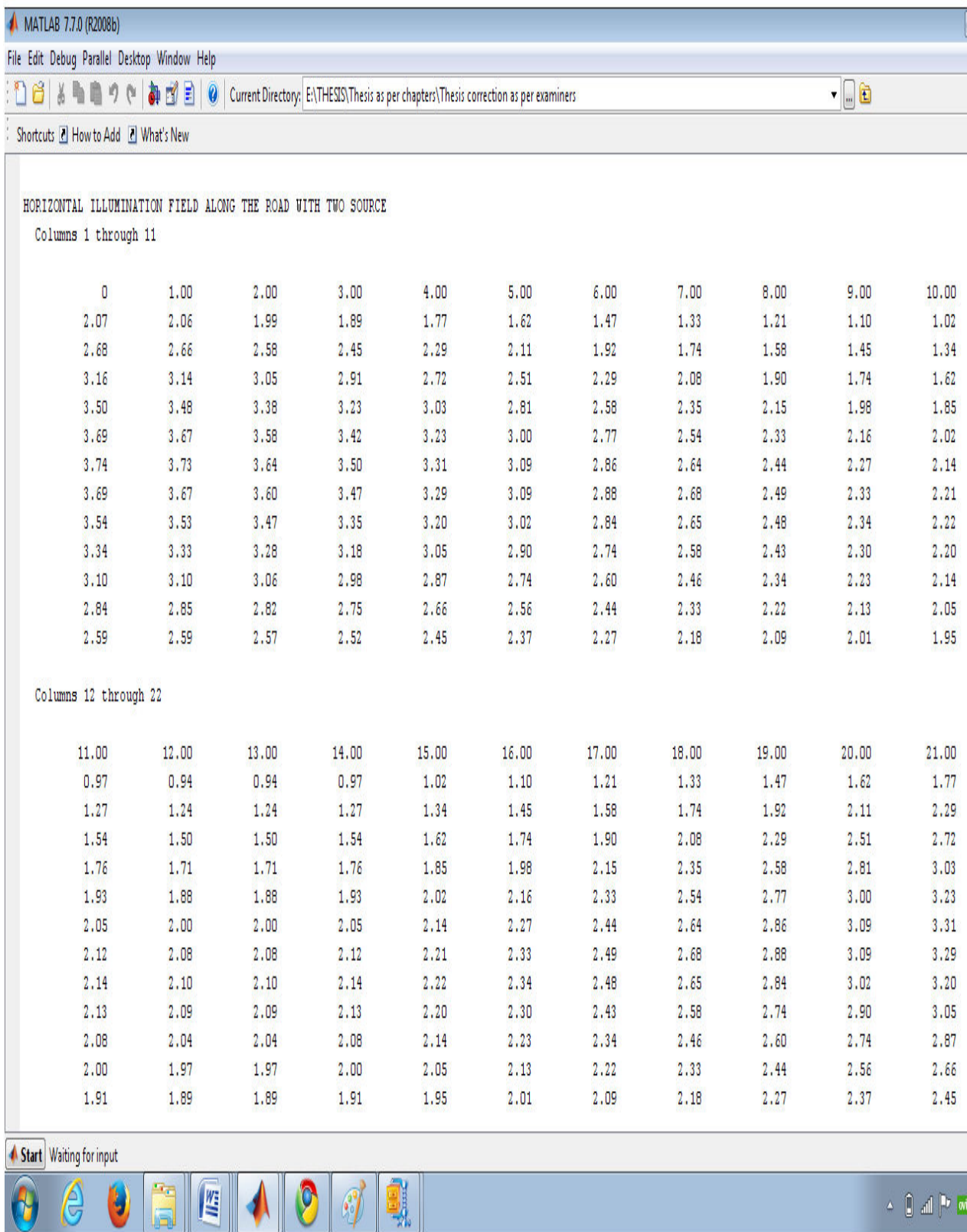

Fig. 5(b) Computer output for horizontal lux levels between two poles

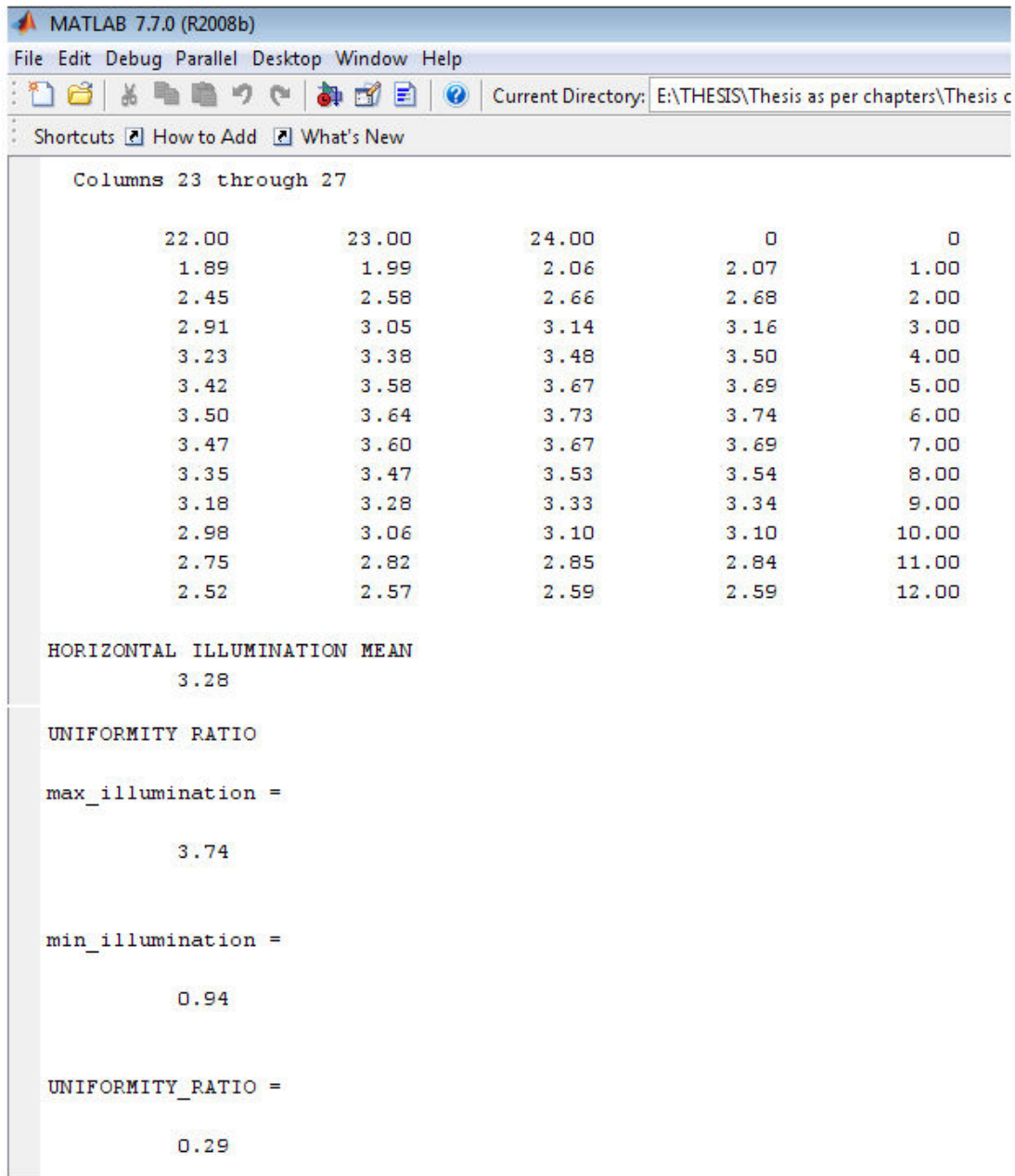

Fig. 5(c) Output of the computer programme

The Figures 6(a) and 6(b) shows the input design parameters for the computer programme and computer output for horizontal lux levels between two poles respectively for two 250W LED sources mounted at height of 16m at tilt angle 14° , at arm length 0m with pole interval as 23m and the road width is 12m. Whereas Figure 6(c) indicates the output of the computer programme for minimum illuminance level, average illuminance level, maximum illuminance level and uniformity ratio.

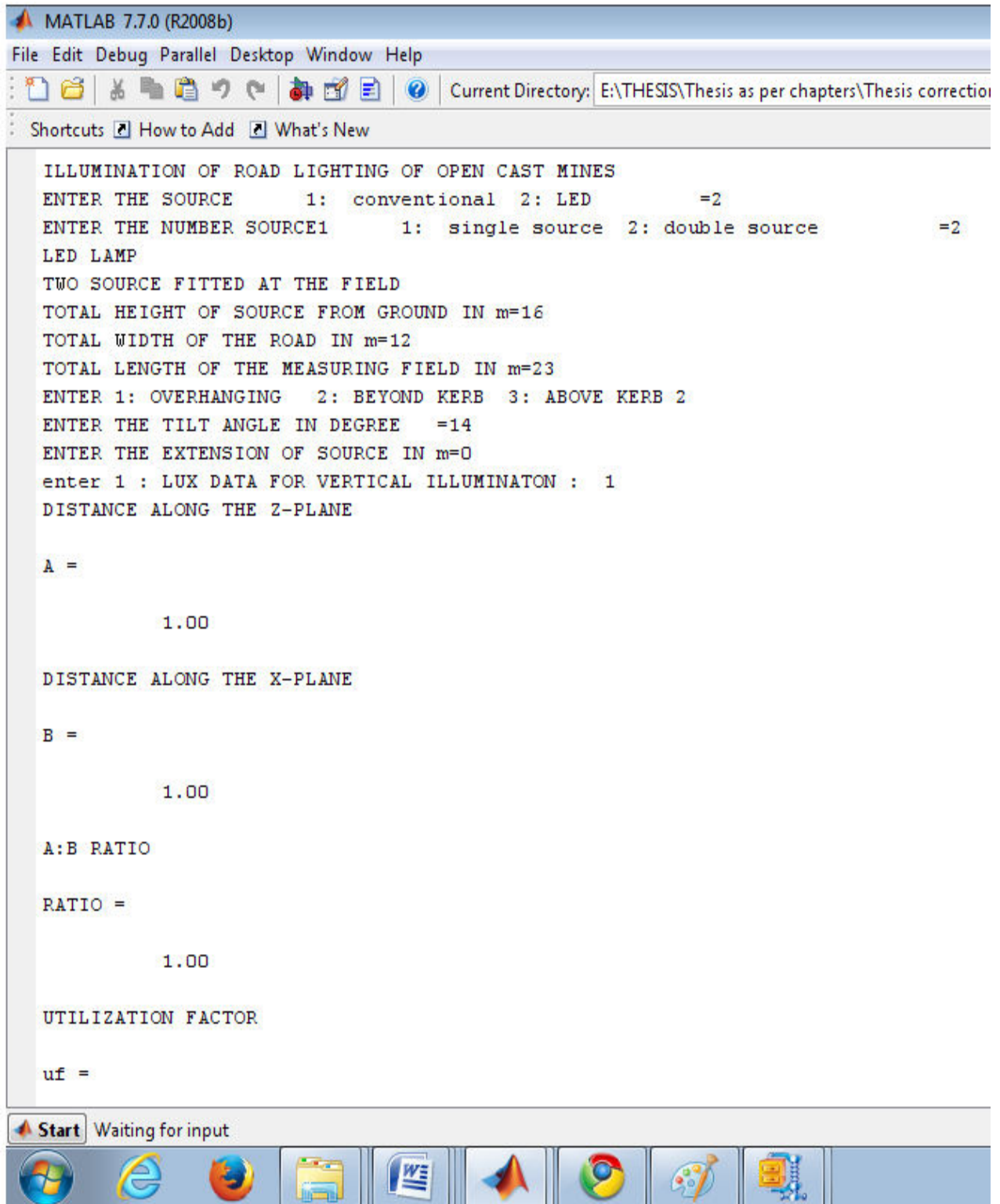

Fig. 6(a) Input design parameters for the computer programme (mounting height=16m; Pole interval=23m)

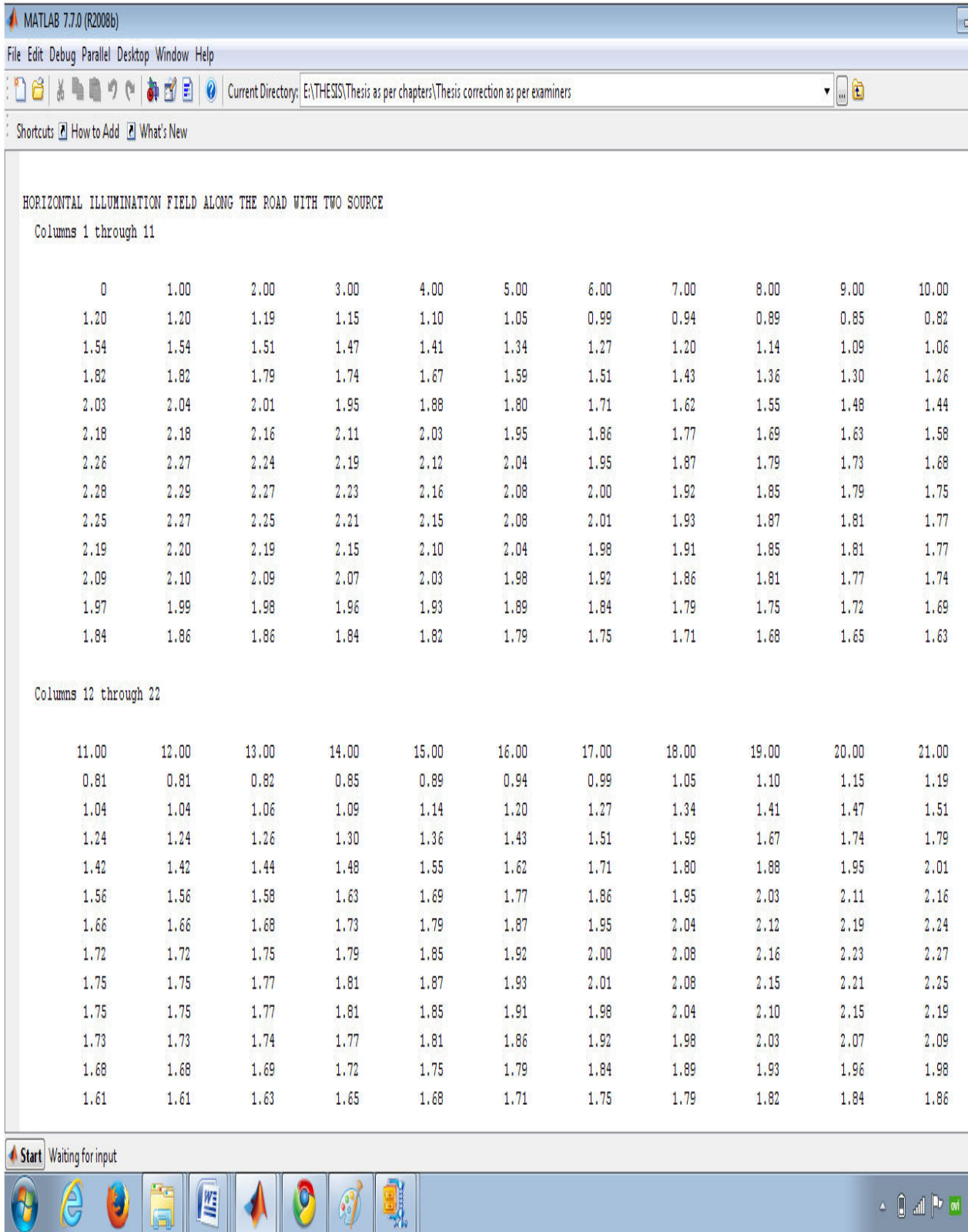

Fig. 6(b) Computer output for horizontal lux levels between two poles

```

MATLAB 7.7.0 (R2008b)
File Edit Debug Parallel Desktop Window Help
Current Directory: E:\THESIS
Shortcuts How to Add What's New

Columns 23 through 25

    22.00         0         0
    1.20         1.20         1.00
    1.54         1.54         2.00
    1.82         1.82         3.00
    2.04         2.03         4.00
    2.18         2.18         5.00
    2.27         2.26         6.00
    2.29         2.28         7.00
    2.27         2.25         8.00
    2.20         2.19         9.00
    2.10         2.09        10.00
    1.99         1.97        11.00
    1.86         1.84        12.00

HORIZONTAL ILLUMINATION MEAN
    2.57

UNIFORMITY RATIO

max_illumination =

    2.29

min_illumination =

    0.81

UNIFORMITY_RATIO =

    0.31

```

Fig. 6(c) Output of the computer programme

The Figures 7(a) and 7(b) shows the input design parameters for the computer programme and computer output for horizontal lux levels between two poles respectively for two 250W LED sources mounted at height of 16m at tilt angle 14° , at arm length 0m with pole interval as 24m and the road width is 12m. Whereas Figure 7(c) indicates the output of the computer

programme for minimum illuminance level, average illuminance level, maximum illuminance level and uniformity ratio.

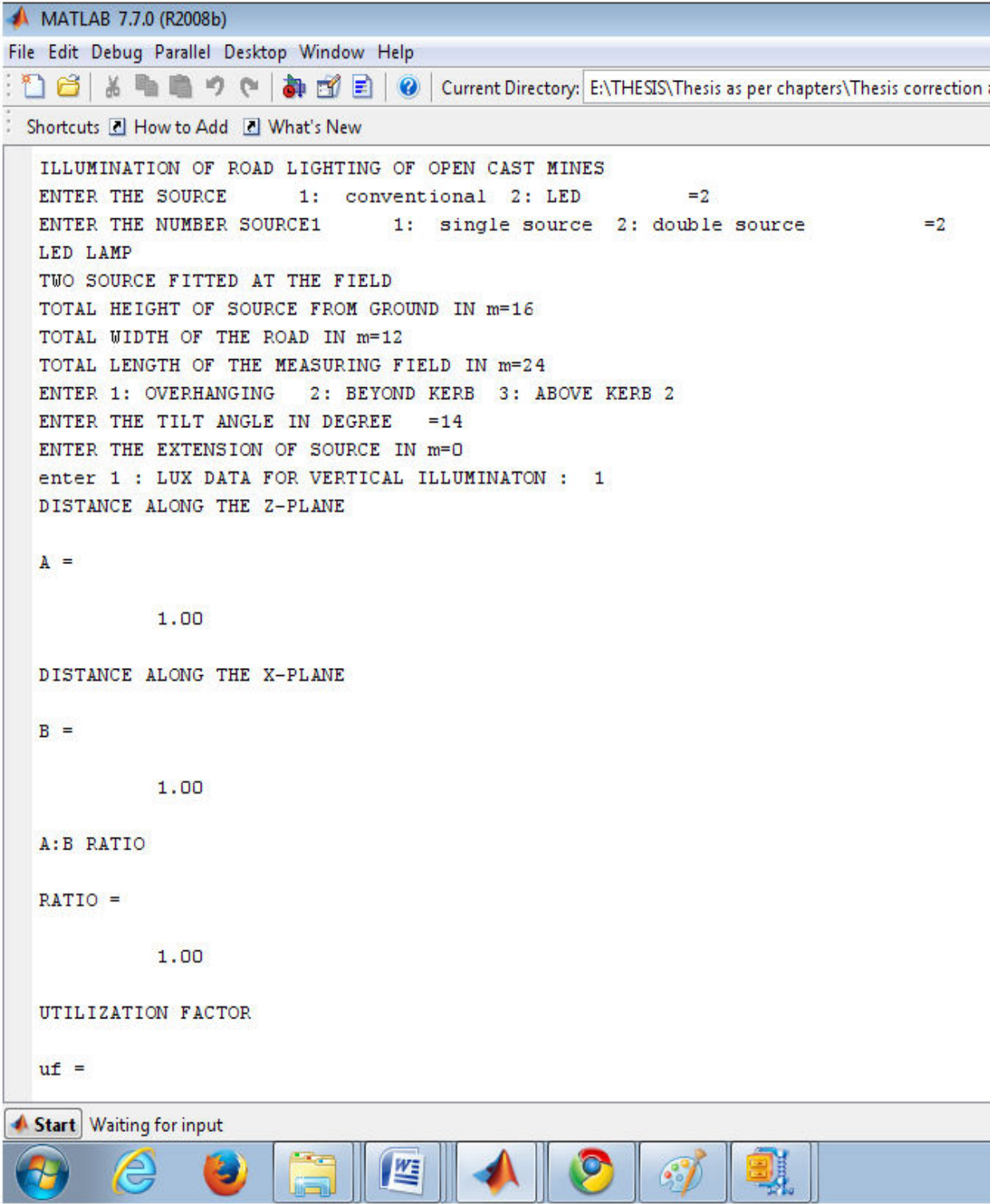

Fig. 7(a) Input design parameters for the computer programme (mounting height=16m; Pole interval=24m)

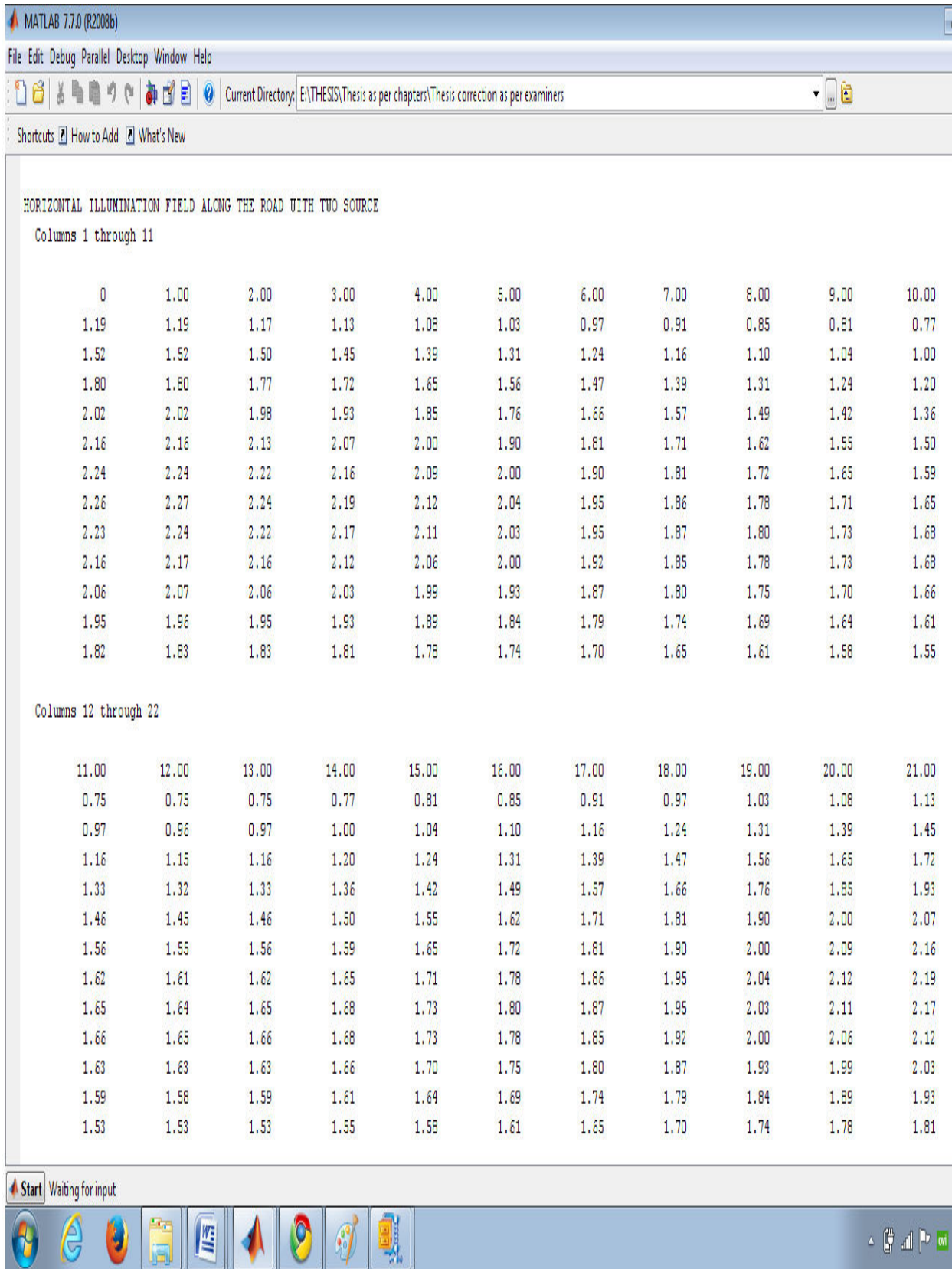
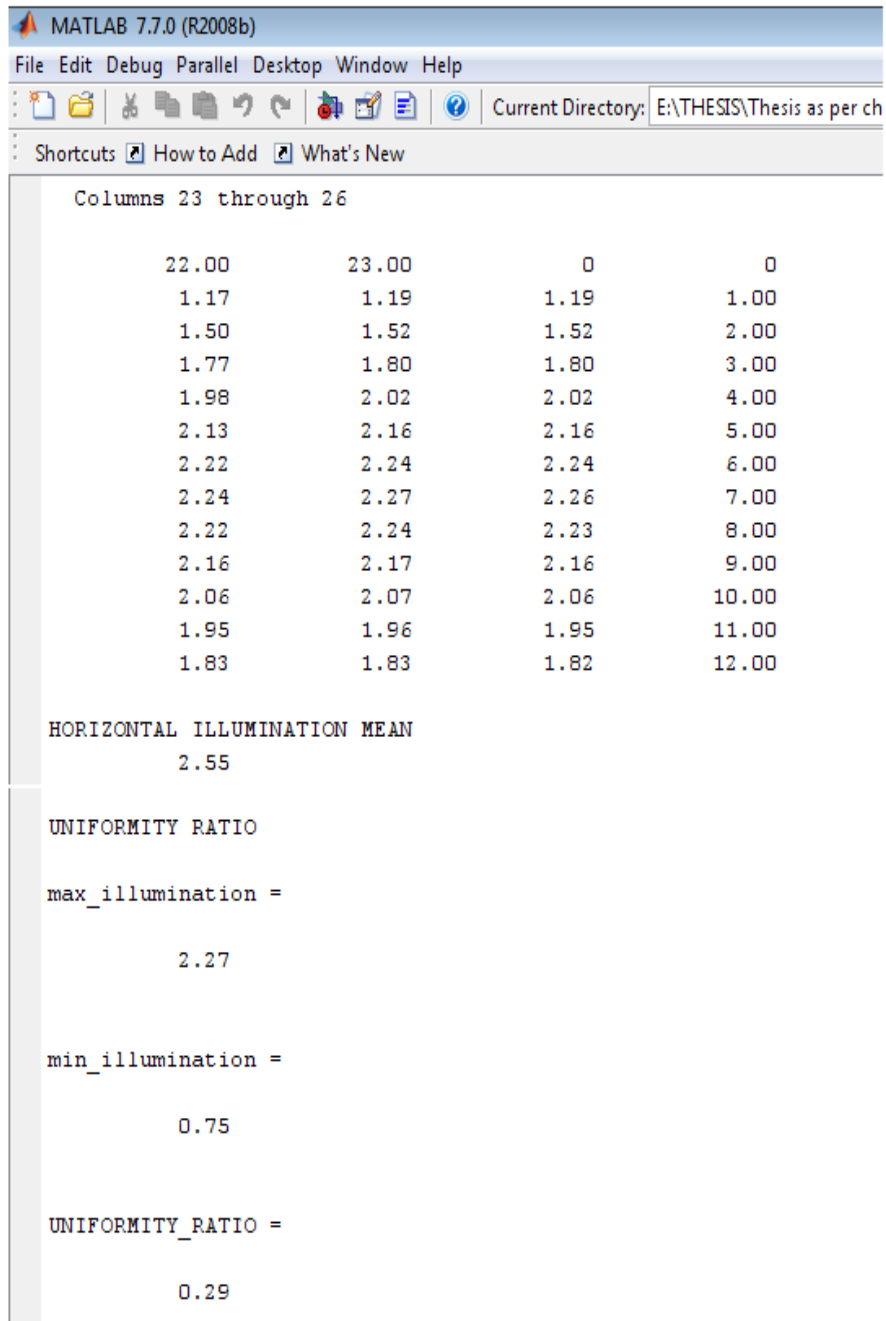

Fig. 7(b) Computer output for horizontal lux levels between two poles



```

MATLAB 7.7.0 (R2008b)
File Edit Debug Parallel Desktop Window Help
Current Directory: E:\THESIS\Thesis as per ch
Shortcuts How to Add What's New

Columns 23 through 26

    22.00    23.00         0         0
    1.17    1.19    1.19    1.00
    1.50    1.52    1.52    2.00
    1.77    1.80    1.80    3.00
    1.98    2.02    2.02    4.00
    2.13    2.16    2.16    5.00
    2.22    2.24    2.24    6.00
    2.24    2.27    2.26    7.00
    2.22    2.24    2.23    8.00
    2.16    2.17    2.16    9.00
    2.06    2.07    2.06   10.00
    1.95    1.96    1.95   11.00
    1.83    1.83    1.82   12.00

HORIZONTAL ILLUMINATION MEAN
    2.55

UNIFORMITY RATIO

max_illumination =

    2.27

min_illumination =

    0.75

UNIFORMITY_RATIO =

    0.29

```

Fig. 7(c) Output of the computer programme

As indicated in Table 6.6, in Section 6.2, the optimum pole intervals are determined for six types of sources at five different mounting heights, such as 8m, 10m, 12m, 14m and 16m. The pole intervals were optimized so as to maintain the minimum lux (E_{\min}) level of 0.5 (as per DGMS) with 0.3 uniformity ratio (U_o) (as per BIS and CIE standards). The values of mounting height, pole interval, E_{\min} , E_{\max} , E_{avg} and U_o are summarized from Figures

1(a,b&c), Figure 2(a,b&c), Figure 3(a,b&c), Figure 4(a,b&c), 3 (a,b&c), 4 (a,b&c), 5 (a,b&c), 6 (a,b&c) and 7 (a,b&c) and given in Table 1. As shown in Table 1, with increase in pole height (i.e. mounting height) from 8m to 16m, in general illuminance level (i.e. both minimum illuminance level and average illuminance level) in the area of lighting decreases. Since, the uniformity ratio is directly proportionate to E_{\min} and inversely proportionate to E_{avg} , the optimum pole interval would be achieved with increase in pole height along with its interval. In case of 8m pole height, the optimum pole interval would be 21m, so as to achieve the minimum required lighting standards. If the pole interval is increased by 1m, i.e. keeping pole interval as 22m, the uniformity ration falls below 0.3. Similarly, for 16m mounting height the optimum spacing would be 23m. By increasing the pole interval by 1m, i.e. keeping pole interval as 24m, the uniformity ratio falls below 0.3.

Table-1: Optimum pole spacing, E_{\min} and U_o values for 250W LED sources at different pole heights

Sl.No	Pole height, m	Poles spacing, m	E_{\min} , lux	E_{\max} , lux	E_{avg} , lux	Uniformity Ratio (U_o)
1	8	21	3.93	33.90	13.17	0.30
2	8	22	3.35	33.85	12.71	0.26
3	10	23	2.16	14.04	7.27	0.30
4	12	24	1.4	6.85	4.65	0.30
5	14	25	0.94	3.74	3.28	0.29
6	16	23	0.81	2.29	2.57	0.31
7	16	24	0.75	2.27	2.55	0.29

PUBLICATIONS BASED ON THESIS WORK

a) Papers published in peer-reviewed International Journal

1. N. Lakshmipathy, Ch.S.N.Murthy & M. Aruna (2014): “Design and Development of Optimum Lighting parameters for Haul Roads in Surface Coal Mines Using MATLAB Software Program - A Case Study”, International Journal of Advanced Research in Electrical, Electronics and Instrumentation Engineering(IJAREEIE), India., Vol. 3(6), pp 10101-10112.
2. N. Lakshmipathy, Ch.S.N.Murthy & M. Aruna (2014): “Problems Encountered in the Types of Lighting Systems Generally Used in Surface Mining Projects A Case Study.”, The International Journal of Engineering and Science (IJES). Vol. 3(9), pp 61-72.
3. N. Lakshmipathy, Ch.S.N.Murthy & M. Aruna (2015): “Factors Affecting Visual Environment in the Surface Mines - A Critical Review”, Science and Technology International Research Network (STIRN), Vol. 1(3), pp 23-42.

b) Papers published in National conference

1. N. Lakshmipathy, Ch.S.N.Murthy & M. Aruna, (2010): “Problems Encountered in Design of Lighting System in Surface Mine Projects”, Proceedings of International Symposium on ‘Emerging Trends in Environment, Health and Safety Management in Mining and Mineral Based Industries”, NITK, Surathkal, August, pp 321.
2. N. Lakshmipathy, Ch.S.N.Murthy & M. Aruna, (2011): “Comparison of Lux Levels and Energy Conservation of Different Lighting Systems Used Generally in Surface Mining Projects”, Proceedings of National Conference on “Recent Advancement in Engineering & Technology”, Dr. TTIT., KGF, March, pp ..

BIO-DATA

Name : N. Lakshmipathy
Date of Birth : 05-01-1969
Address : Associate professor, Department of Electrical and Electronic
Engineering, Dr. TTIT, KGF – 563120, Karnataka – State, India
Phone No : +91- 8762208659
E – Mail : 1. nlplakshmipathy@gmail.com
2. nlpj_lakshmipathy@yahoo.co.in

Professional Experiences:

- Joined on consolidated basis as lecturer in Dr.T.T.I.T, Oorgaum, K.G.F –563120 from 17-05-2000 to 19-12-2000.
- Joined as a lecturer in Dr.T.T.I.T, Oorgaum, K.G.F –563120 from 20-12-2000 to 28-02-2006.
- Worked as a senior lecturer in Dr.T.T.I.T, Oorgaum, K.G.F –563120 from 01-03-2006 to 31-08-2006
- Working as an Assistant Professor in Dr.T.T.I.T, Oorgaum, K.G.F –563120 from 01-09-2006 to 01-08-2015.
- Working as an Associate Professor in Dr.T.T.I.T, Oorgaum, K.G.F –563120 from 01-09-2015 to till date.

Membership of professional bodies: 1. Institution of Engineers, India.
2.The Indian Society For Technical Education.

Publications: 1. International Journals - 03
2. National conference - 02

Students projects guided: UG - 23 (Twenty three)